

We make it sharp



**FOX<sup>®</sup> KNIVES**

**FK<sup>®</sup> MD**



**BlackFOX<sup>®</sup>**

**FOX<sup>®</sup>Edge**

\* I materiali e le specifiche tecniche riportati nei cataloghi sono soggetti a variazioni senza preavviso, in funzione della disponibilità delle materie prime. Tutte le immagini pubblicate hanno esclusivamente una finalità illustrativa e sono da considerarsi indicative dei prodotti rappresentati, incluse le timbrature delle lame. I prodotti presenti in questo catalogo non sono destinati all'uso alimentare e, di conseguenza, sono esenti dall'applicazione delle disposizioni previste dal Regolamento CE 1935/2004, 2023/06 e dal D.Lgs. 29/17 e successive modifiche

Materials and specifications shown in the catalogs are subject to change without notice, depending on the availability of raw materials. All images published are for illustrative purposes only and are to be considered indicative of the products represented, including blade engravings. All products in this catalog are not intended to be made for use with food, consequently they are exempt from the measures governed by CE Regulation 1935/2004, 2023/06, and D-Lgs. 29/17, and succ. mod

# INDICE-INDEX

WORKBOOK 2025

|  |     |
|--|-----|
| FOX KNIVES CHIUDIBILI   FOLDING .....  | 22  |
| FOX KNIVES KARAMBIT .....  | 92  |
| FOX KNIVES FISSI   FIXED .....   | 114 |
| FOX KNIVES MULTIUSO, UTILITY E RESCUE   MULTIPURPOSE, UTILITY AND RESCUE ..... | 150 |
| FOX KNIVES TAGLIA SIGARI   CIGAR CUTTERS .....                                 | 182 |
| FOX KNIVES LINEA CLASSICA   CLASSIC LINE .....                                 | 196 |
| FOX KNIVES FKMD .....  | 206 |
| VIPER CHIUDIBILI   FOLDING .....   | 238 |
| VIPER FISSI   FIXED .....  | 268 |
| BLACK FOX .....  | 288 |
| FOX EDGE .....   | 314 |
| ACCESSORI   ACCESSORIES .....  | 320 |
| LEGENDA E SOMMARIO   KEY AND SUMMARY .....                                     | 330 |



CORE TANTO FX-612 ORB | designed by VOX

N690Co black idroglider stone washed | Black idroglider stone washed N690Co  
Manico FRN® arancione | Orange FRN® handle

# LE ANIME DI FOX GROUP

## THE SOULS OF FOX GROUP

**Fox Knives:** la capacità di intercettare nuovi segnali da un mercato globale. **Due Cigni:** l'insossidabile aspirazione allo stile. **Defcon 5:** l'audacia di spingersi verso orizzonti inesplorati. **Viper:** la precisione e l'eleganza che nascono dall'incontro tra tradizione e innovazione.

Il DNA di Fox Group prende forma dall'unione delle realtà che oggi costituiscono il Gruppo industriale, caratterizzandolo con i tratti distintivi sintetizzati nei suoi quattro marchi: quattro simboli che sprigionano l'energia di aziende giovani nello spirito, ma con una sapienza affinata in quasi due secoli di esperienza manifatturiera. Come insegna la nostra storia, c'è un solo modo per affrontare e vincere la sfida del tempo: sapersi mettere in discussione, con umiltà ed entusiasmo.

**Fox Knives:** the ability to capture new signals from a global market. **Due Cigni:** the unwavering pursuit of style. **Defcon 5:** the boldness to venture into uncharted horizons. **Viper:** the precision and elegance born from the fusion of tradition and innovation.

The DNA of Fox Group takes shape from the union of the entities that today form the industrial group, defining it through the distinctive traits embodied by its four brands—four symbols that radiate the energy of companies young in spirit yet enriched by nearly two centuries of manufacturing expertise.

As our history teaches us, there is only one way to face and overcome the challenge of time: the ability to question oneself, with humility and enthusiasm.

## LA NUOVA ACQUISIZIONE DEL MARCHIO VIPER

### THE NEW VIPER BRAND ACQUISITION

Dal 1° gennaio 2025, Tecnocut S.n.c., con il suo storico marchio Viper, è ufficialmente entrata a far parte di Oreste Frati S.r.l. – FOX Group. Questa integrazione ha permesso di valorizzare pienamente l'identità e i valori distintivi di Viper — design innovativo, materiali di alta qualità e un carattere unico — senza mai perdere di vista le sue radici. Le persone che, con passione e competenza, hanno reso grande il marchio Viper sono rimaste parte integrante del team, continuando a garantire i più alti standard di qualità e professionalità. Nei mesi successivi, i processi aziendali di Tecnocut sono stati integrati con successo nel sistema operativo consolidato di Oreste Frati S.r.l., e nuovi modelli sono stati lanciati, arricchendo l'offerta e segnando l'inizio di una nuova fase di crescita. Il marchio Viper ha davanti a sé un futuro luminoso, e questo nuovo capitolo rappresenta una pietra miliare nella sua storia.

As of January 1, 2025, Tecnocut S.n.c., along with its historic brand Viper, has officially become part of Oreste Frati S.r.l. – FOX Group. This integration has fully enhanced Viper's identity and distinctive values — innovative design, high-quality materials, and a unique character — while staying true to its roots. The passionate and skilled people who have contributed to Viper's success remain an integral part of the team, continuing to uphold the highest standards of quality and professionalism. In the following months, Tecnocut's business processes were successfully integrated into Oreste Frati S.r.l.'s well-established operating system, and new models were launched, enriching the product range and marking the beginning of a new phase of growth. Viper has a bright future ahead, and this new chapter represents a milestone in its history.



# LA NOSTRA STORIA

## OUR STORY

Nel 1977, Oreste Frati fondò le Coltellerie FOX, unendo tradizione e innovazione. L'azienda si è affermata come leader nel settore dei coltelli a livello nazionale e internazionale, grazie alla qualità dei suoi prodotti e alla costante ricerca tecnologica.

Nel 2008, Frati, insieme al figlio Gabriele e ad Andrea De Lorenzi, fondò Euro Knives Italia Srl per rispondere alle crescenti richieste produttive che arrivavano dal mercato. Nel 2020, Fox Knives acquisì Euro Knives, rendendola a tutti gli effetti parte del Fox Group e integrando in un'unica moderna sede produttiva tutte le fasi di progettazione e produzione dei marchi FOX, FKMD, Due Cigni e Viper.

Fox Knives utilizza tecnologie avanzate e personale altamente qualificato per produrre coltelli di elevata qualità destinati a forze armate, caccia e tempo libero, rispettando le normative ISO 9001. L'azienda è anche registrata come fornitore ufficiale della NATO, confermando il suo standard di eccellenza nel settore militare.

Specializzata nei coltelli outdoor, Fox Knives ha adottato un approccio "lean" e investito in automazione con tecnologie 4.0. Il gruppo Fox, che include anche i marchi Due Cigni e Defcon 5, rappresenta un perfetto equilibrio tra tradizione e innovazione, artigianalità e industrializzazione. La collaborazione tra designer esterni e tecnici interni ha permesso la creazione di prodotti unici e moderni, con una costante attenzione al futuro.

"La capacità di esistere e crescere è profondamente legata al luogo in cui continuano a fiorire artigiani di talento in grado di lavorare ai più alti standard"

In 1977, Oreste Frati founded Coltellerie FOX, combining tradition and innovation. The company established itself as a leader in the knife industry both nationally and internationally, thanks to the quality of its products and its continuous technological research.

In 2008, Frati, together with his son Gabriele and Andrea De Lorenzi, founded Euro Knives Italia Srl to meet the growing production demands from the market. In 2020, Fox Knives acquired Euro Knives, making it an integral part of the Fox Group and bringing all design and production phases of the FOX, FKMD, Due Cigni, and Viper brands together in a single, modern manufacturing facility.

Fox Knives employs advanced technologies and highly skilled personnel to produce high-quality knives for the armed forces, hunting, and leisure, complying with ISO 9001 standards. The company is also registered as an official NATO supplier, confirming its standard of excellence in the military sector.

Specializing in outdoor knives, Fox Knives has adopted a "lean" approach and invested in automation with Industry 4.0 technologies. The Fox Group, which also includes the Due Cigni and Defcon 5 brands, represents a perfect balance between tradition and innovation, craftsmanship and industrialization. The collaboration between external designers and in-house technicians has led to the creation of unique and modern products, with a constant focus on the future.

"The ability to exist and grow is deeply tied to the place where continues to flourish talented craftsmen, which are able to work up to the highest standard"

Gabriele Frati



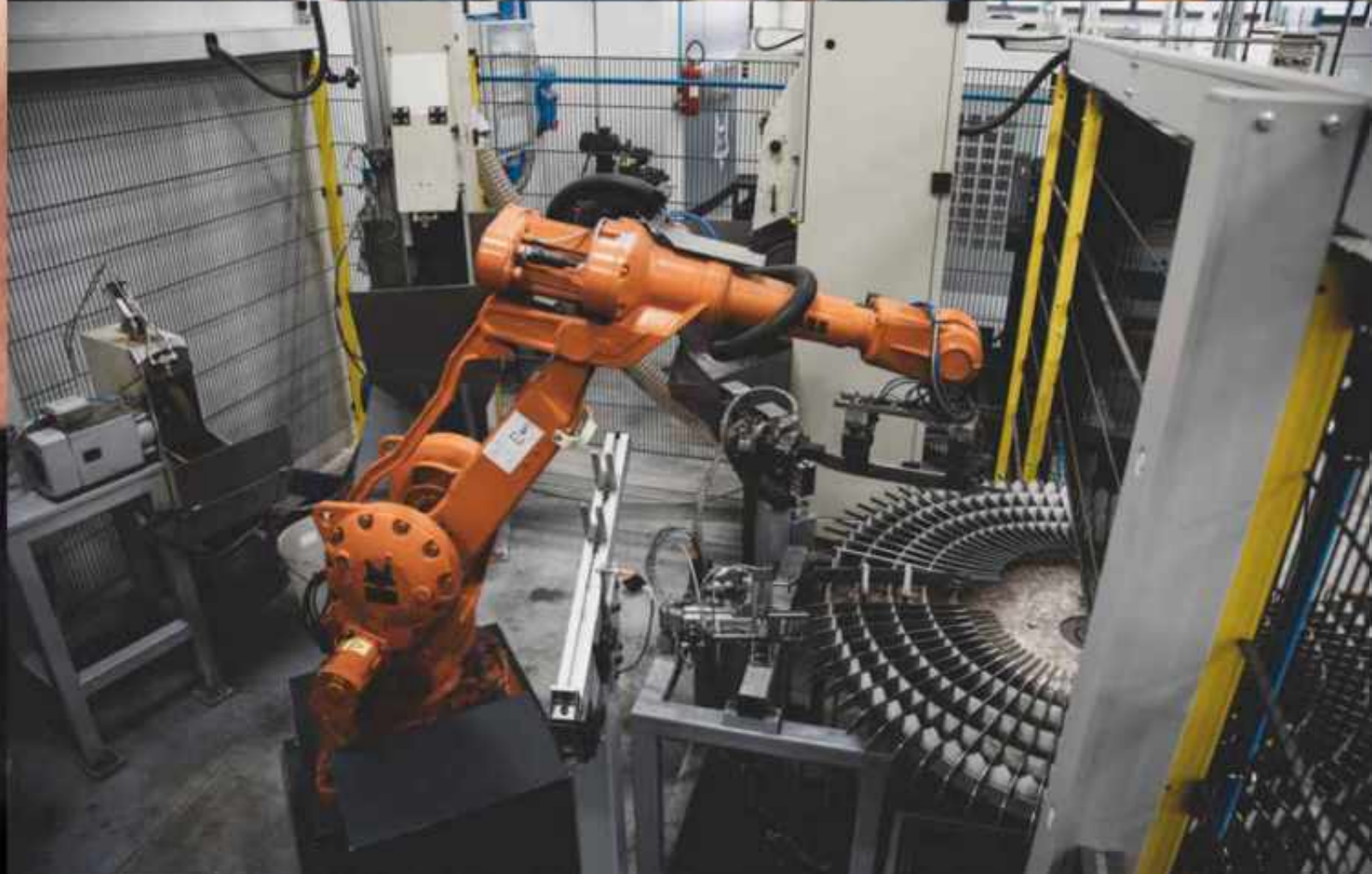

I NOSTRI

# RICONOSCIMENTI OUR AWARDS

Con gli ultimi premi vinti nel 2025, tra cui la vittoria nella categoria "Best Product | Leisure" agli IF Design Awards 2025 e il "Best Kitchen/Cooking Knife" agli IWA Knife Awards 2025, Fox supera la soglia dei diciassette riconoscimenti ottenuti dal 2009 ad oggi. Questo traguardo rappresenta solo la punta dell'iceberg di un successo ancora più significativo, di cui andare fieri: la presenza dei prodotti Fox in 58 Paesi, distribuiti sui cinque continenti, e, soprattutto, l'elevato livello di fidelizzazione dei clienti in ogni parte del mondo.

With the latest awards won in 2025, including victory in the "Best Product | Leisure" category at the IF Design Awards 2025 and "Best Kitchen/Cooking Knife" at the IWA Knife Awards 2025, Fox surpasses the milestone of seventeen recognitions earned from 2009 to today. This achievement represents just the tip of the iceberg of an even greater success to be proud of: the presence of Fox products in 58 countries across five continents and, most importantly, the high level of customer loyalty worldwide.

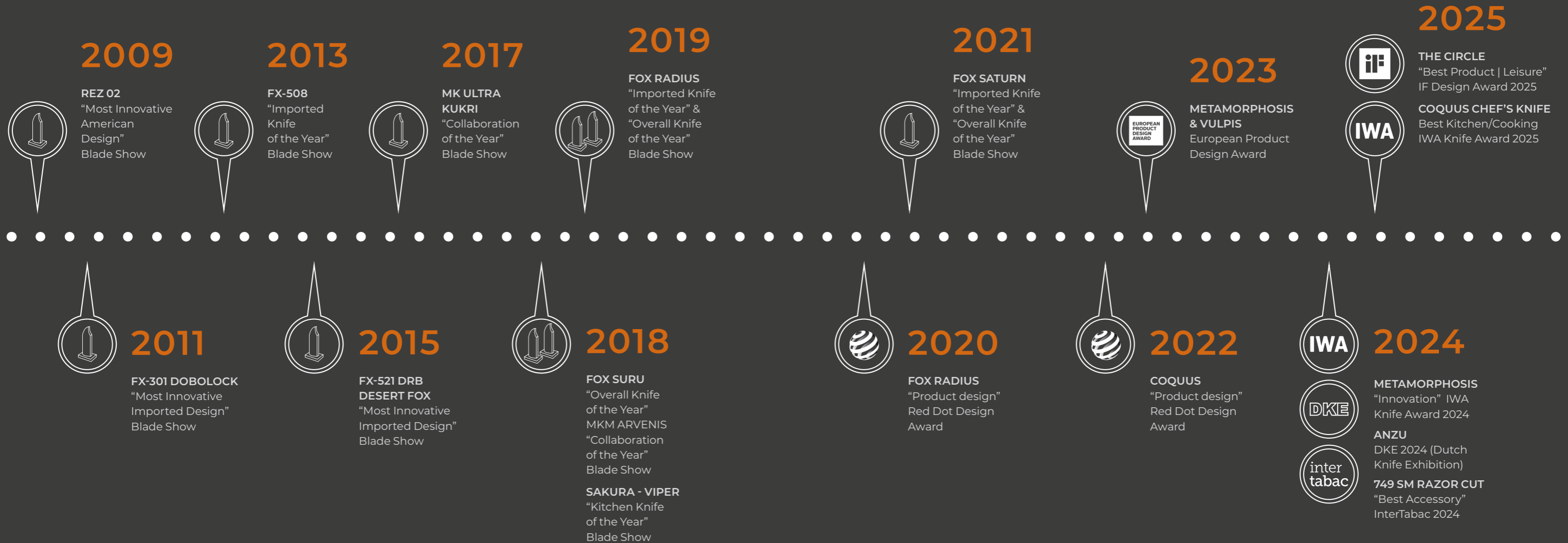



#### SATINATURA SATINING

Levigatura operata sulla lama in un'unica direzione con abrasivi di grado via via crescente. Questa operazione risalta le linee della lama e riduce il riverbero riflettente.

Sanding performed on the blade in a single direction with gradually increasing grade of abrasives. This brings out the lines of the blade and reduces reflective glare.



#### SABBIATURA SANDBLASTING

Abrasione superficiale dell'acciaio mediante un forte getto di sabbia o sfere di vetro che ne rende opaca la finitura.

Surface abrasion of the steel obtained with a strong jet of sand or glass beads which gives it an opaque finish.



#### STONE WASHED

Trattamento che produce lievi scalfitture superficiali sull'acciaio mediante impatto con pietra o ceramica. Si ottiene un effetto invecchiato che non compromette le qualità della lama. Questa lavorazione può essere applicata su superfici già finite con trattamenti diversi come, per esempio, l'idroglider o il PVD.

Treatment that produces slight surface scratches on steel by impact with stone or ceramic. An aged effect is obtained which does not compromise the qualities of the blade. This process can be applied on surfaces that are already finished with different treatments such as, for example, idroglider or PVD.



#### COARSE STONE WASHED

La finitura prevede due passaggi: inizialmente, una sabbiatura con getti di corindone che conferisce un aspetto opaco, più scuro e grezzo rispetto alla sabbiatura tradizionale. Successivamente, viene applicato il trattamento stone wash.

Finishing includes two steps: initially, a sandblasting with corundum jets that gives an opaque, darker and coarser appearance than traditional sandblasting. Next, the stone wash treatment is applied.



#### BAGNO IN ACIDO CLORIDRICO ETCHING HYDROCHLORIC ACID

Il bagno in acido cloridrico delle lame in acciaio damasco è un trattamento chimico utilizzato per evidenziare il caratteristico motivo della lama. Questo processo, noto anche come attacco acido, serve a far risaltare i contrasti tra i diversi strati di acciaio che compongono la lama damascata.

The hydrochloric acid etching of damascus steel blades is a chemical treatment used to highlight the characteristic pattern of the blade. This process, also known as acid attack, is used to bring out the contrasts between the different layers of steel that make up the damascus blade.



#### BLACK IDROGLIDER STONE WASHED

Speciale rivestimento superficiale a base di PTFE molto resistente ad abrasioni e all'acqua. È possibile applicarlo in vari colori. Nella maggior parte dei casi, a questa finitura viene poi applicato il trattamento stone washed.

Special PTFE-based surface coating that is very resistant to abrasion and water. It can be applied in various colors. In most cases, stone washed treatment is then applied to this finish.



#### PVD

Il Physical Vapor Deposition è un processo che consiste nella deposizione di sottili strati di materiali, come nitrato di titanio o zirconio, sulla superficie della lama attraverso la vaporizzazione fisica in un ambiente sottovuoto. Il risultato offre numerosi vantaggi come: una maggiore durezza e resistenza all'usura, protezione dalla corrosione ed un'estetica migliorata, con finiture eleganti che vanno dall'effetto dorato al nero opaco.

Physical Vapor Deposition is a process that involves the deposition of thin layers of materials, such as titanium nitride or zirconium, on the surface of the blade through physical vaporization in a vacuum environment. The result offers numerous benefits such as: increased hardness and wear resistance, corrosion protection, and improved aesthetics, with elegant finishes ranging from golden to matte black.



#### TOP SHIELD®

Rivestimento a base di vernice ceramica che garantisce alta protezione da graffi, offre un'alta resistenza da delaminazione fino a 450°C. Questo tipo di rivestimento, sviluppato con tecnologie moderne, crea una barriera protettiva sulla superficie della lama, riducendo l'attrito e prevenendo l'ossidazione, anche in condizioni di elevata umidità o esposizione a sostanze aggressive.

Ceramic paint-based coating that provides high protection from scratches, offers high resistance from delamination up to 450°C. This type of coating, developed with modern technologies, creates a protective barrier on the surface of the blade, reducing friction and preventing oxidation, even under conditions of high humidity or exposure to aggressive substances.

Le principali  
The main

# FINITURE

# FINISHES

I **principali** - The main

# TIPI DI ACCIAIO

## TYPE OF STEEL

### DAMASCO | DAMASCUS

Il damasco consiste nella stratificazione di lamine di differenti acciai. Una volta creato il pacchetto base, questo viene ripiegato su sé stesso varie volte. Ad ogni piegatura il numero totale di lamine raddoppia. In fase di finitura le lame vengono sottoposte all'attacco di un acido, che reagendo in modo differente con i diversi acciai crea la tipica trama.

Il damasco può essere inossidabile o ad alto tenore di carbonio. A seconda del numero di volte e del modo in cui viene ripiegato si ottengono differenti trame.

Damascus consists of layering sheets of different steels. Once the basic package is created, it is folded back on itself several times. With each folding, the total number of blades doubles. During finishing, the blades are subjected to the attack of an acid, which reacts differently with the different steels to create the typical texture. Damascus can be stainless or high-carbon. Depending on the number of times and the way it is folded, different textures are obtained.

### ELMAX

L'Elamx è un acciaio a polveri sinterizzato di terza generazione ad alta percentuale di cromo, vanadio e molibdeno. Questa composizione consente al metallo di acquisire resistenza all'usura, alla compressione, all'ossidazione ed un'ottima stabilità dimensionale, con capacità di mantenere la sua forma anche dopo un utilizzo intensivo. Il processo PM combinato con l'alta concentrazione di cromo predispone l'Elmax ad una buona levigatura e ad un'eccellente lucidatura.

Elamx is a third-generation sintered powder steel with a high proportion of chromium, vanadium and molybdenum. This composition enables the metal to acquire resistance to wear, compression, oxidation and excellent dimensional stability, with the ability to retain its shape even after intensive use. The PM process combined with the high concentration of chromium predisposes Elmax to good grinding and excellent polishing.

### NIOLOX

Il Niolox è un'acciaio inossidabile che include, nell asua composizione, niobio, cromo e vanadio. Ha un'elevatissima resistenza all'ossidazione da acqua, ma anche da liquidi più aggressivi. Avendo una grana molto fine, questo ne migliora notevolmente il tagliente. Ideale per cacciatori, survivalisti e chiunque abbia bisogno di uno strumento affidabile nel proprio lavoro quotidiano.

Niolox is a stainless steel that includes niobium, chromium and vanadium in its composition. It has a very high resistance to oxidation by water as well as more aggressive liquids. Having a very fine grain, this greatly improves its sharpness. Ideal for hunters, survivalists and anyone who needs a reliable tool in their daily work.

### D2

Sebbene nel gergo degli appassionati venga spesso definito "semi-inossidabile", il contenuto di Cromo di circa il 12% conferisce al D2 una buona resistenza all'ossidazione in condizioni d'uso normali. Rispetto agli acciai inox si distingue per una superiore tenuta filo e soprattutto per la robustezza, che lo rende adatto alla costruzione di solidi strumenti da lavoro.

Although in the jargon of enthusiasts it is often referred to as "semi-stainless," the chromium content of about 12 percent gives D2 good resistance to oxidation under normal use. Compared with stainless steels, it is distinguished by superior thread retention and, above all, strength, making it suitable for the construction of solid working tools.

### MAGNACUT

Il Magnacut è un acciaio inossidabile prodotto mediante metallurgia delle polveri che garantisce un'elevata finezza e purezza. Il rapporto tra tenacità e ritenzione del filo è eccezionale ed è anche estremamente resistente alla corrosione. A seconda del trattamento termico effettuato sono possibili elevati livelli di durezza. Il Magnacut è adatto a tutti i tipi di lame di coltello, siano essi coltelli da caccia, da esterno o pieghevoli. Risulta particolarmente interessante per la realizzazione di lame dove il filo tagliente deve essere fine e stabile.

Magnacut is a stainless steel produced by powder metallurgy that provides high fineness and purity. The ratio of toughness to wire retention is exceptional and it is also extremely resistant to corrosion. Depending on the heat treatment performed, high levels of hardness are possible. Magnacut is suitable for all types of knife blades, whether hunting, outdoor or folding knives. It is particularly attractive for making blades where the cutting edge must be fine and stable.

### M390

L'M390 è un acciaio inossidabile di terza generazione, prodotto con la metallurgia delle polveri, caratterizzato da un'estrema resistenza all'usura e un'alta resistenza alla corrosione. Ha un'elevata tenacità e stabilità dimensionale, un'ottima flessibilità e un'alta resistenza agli shock meccanici. L'acciaio M390 è ampiamente utilizzato nella produzione di coltelli pieghevoli progettati per attività all'aperto, come campeggio, escursionismo e caccia. Questo acciaio consente ai coltelli di eccellere nei compiti quotidiani, rendendoli compagni indispensabili per gli appassionati di outdoor che cercano affidabilità e durata nei loro strumenti.

M390 is a third-generation stainless steel produced by powder metallurgy, characterized by extreme wear resistance and high corrosion resistance. It has high toughness and dimensional stability, excellent flexibility and high resistance to mechanical shocks. M390 steel is widely used in the production of folding knives designed for outdoor activities, such as camping, hiking and hunting. This steel enables the knives to excel at everyday tasks, making them indispensable companions for outdoor enthusiasts who seek reliability and durability in their tools.

### BECUT

Il Becut è un acciaio inossidabile brevettato, arricchito con niobio per garantire un'ottima tenacità, una buona ritenzione del filo e un'elevata resistenza all'usura. Grazie alla sua struttura a grana fine, offre anche una notevole resistenza alla corrosione.

Becut is a patented stainless steel enriched with niobium to provide excellent toughness, good wire retention and high wear resistance. It also offers considerable corrosion resistance due to its fine-grained structure resistance with fine-grained texture.

### AISI 420

L'alto contenuto di cromo nell'acciaio AISI 420 contribuisce alla resistenza alla corrosione, mentre il contenuto di carbonio permette la formazione della struttura martensitica dopo il trattamento termico, conferendo durezza e resistenza all'usura.

The high chromium content in AISI 420 steel contributes to corrosion resistance, while the carbon content allows the formation of the martensitic structure after heat treatment, imparting hardness and wear resistance.

### N690Co

La durezza dell'acciaio è un fattore fondamentale nella scelta di un coltello, influenzando direttamente le sue prestazioni e la sua durata nel tempo. La durezza ideale dell'acciaio N690Co si attesta sui 58-60 HRC e si traduce in lame con un ottimo compromesso fra capacità di taglio, resistenza alle sollecitazioni e facilità di riaffilatura. E' ideale per i chiudibili per l'uso giornaliero e per i coltelli da caccia, spesso a contatto con sangue ed altre sostanze aggressive.

Steel hardness is a key factor in choosing a knife, directly influencing its performance and durability. The ideal hardness of N690Co steel is 58-60 HRC, resulting in blades with an excellent compromise between cutting ability, stress resistance and ease of regrinding. It is ideal for everyday closers and hunting knives, which are often in contact with blood and other aggressive substances.

### M398

M398 si distingue come una lega inossidabile che fa il possibile in termini di resistenza all'usura. Per approfondire un po', M398 vanta una composizione leggermente diversa rispetto all'acciaio M390. Include più carbonio, una dose più elevata di vanadio e persino un tocco più di tungsteno, il tutto contribuendo alle sue distinte qualità prestazionali. Tra le leghe inossidabili, mostra potenzialmente una delle migliori capacità di tenuta del filo. L'M398 rimane affilato e pronto anche dopo un uso prolungato: questa è la caratteristica distintiva dell'acciaio M398.

M398 stands out as a stainless alloy that goes the extra mile in terms of wear resistance. To elaborate a bit, M398 boasts a slightly different composition than M390 steel. It includes more carbon, a higher dose of vanadium, and even a touch more tungsten, all contributing to its distinct performance qualities. Among stainless alloys, it shows potentially one of the best wire-holding capabilities. It remains sharp and ready even after prolonged use-this is the distinguishing feature of M398 steel.

### CPM S90V

L'acciaio CPM S90V offre un ottimo equilibrio tra resistenza all'usura e ritenzione del filo, grazie al suo alto contenuto di vanadio. Le sue prestazioni nel mantenere un bordo affilato e nel resistere all'abrasione sono quasi ineguagliabili, rivaleggiando con quelle del CPM S110V. L'affilatura richiede però tecniche e strumenti avanzati per una corretta manutenzione.

CPM S90V steel offers an exceptional balance of wear resistance and wire retention due to its high vanadium content. Its performance in maintaining a sharp edge and resisting abrasion is almost unmatched, rivaling that of CPM S110V. However, sharpening requires advanced techniques and tools for proper maintenance.

### AISI 440

L'acciaio 440 fa parte degli acciai inossidabili o di quegli acciai legati che contengono un minimo del 10% di cromo, conferendo a queste leghe una maggiore resistenza alla corrosione. L'acciaio 440 si riferisce in realtà a quattro tipi di acciaio: acciaio 440A, 440B, 440C e 440F, che differiscono solo in base al livello di carbonio nella loro composizione.

440 steel is one of the stainless steels or those alloy steels that contain a minimum of 10 percent chromium, giving these alloys greater corrosion resistance. Steel 440 actually refers to four types of steel: steel 440A, 440B, 440C, and 440F, which differ only by the level of carbon in their composition.

I **principali** - The main

# TIPI DI AFFILATURA

## TYPES OF GRIND

### AFFILATURA PIATTA

#### FULL FLAT GRIND

L'affilatura piatta completa prevede che il filo si assottigli in modo uniforme su entrambi i lati, partendo dal dorso della lama. Tuttavia, una vera affilatura piatta completa priva di smusso secondario è oggi poco comune, poiché, pur offrendo un'eccezionale affilatura, risulta meno resistente nel tempo. Esiste anche l'affilatura piatta alta, che si differenzia dall'affilatura piatta completa perché conserva una piccola sezione piatta della lama vicino al dorso, prima di iniziare a rastremarsi verso il filo. In questa tipologia di affilatura piatta alta (diversa dall'affilatura Scandi), il bisello ha origine in prossimità del dorso.

Full flat sharpening involves tapering the edge evenly on both sides, starting from the back of the blade. However, true full flat sharpening without a secondary bevel is uncommon today because, while it offers exceptional sharpening, it is less durable over time. There is also high flat sharpening, which differs from full flat sharpening in that it retains a small flat section of the blade near the back, before it begins to taper toward the edge. In this type of high flat sharpening (different from Scandi sharpening), the bevel originates near the back.

### AFFILATURA CONCAVA

#### HOLLOW GRIND

In questo tipo di lavorazione, i lati della lama si curvano verso l'interno fino a incontrarsi. Il profilo concavo offre un taglio esclusivo, simile a quello di un rasoio, ma non è molto durevole e può opacizzarsi facilmente. Il design concavo è popolare nella comunità dei cacciatori, poiché è ideale per operazioni specifiche come lo scuoiò.

In this type of machining, the sides of the blade curve inward until they meet. The concave profile offers a unique, razor-like cut, but it is not very durable and can dull easily. The concave design is popular in the hunting community because it is ideal for specific operations such as skinning.

### AFFILATURA COMPOSTA

#### COMPOUND GRIND

Le affilature composte sono uno stile relativamente nuovo e di tendenza per la finitura delle lame, che ne combina due diverse tipologie sulla stessa lama, per ragioni estetiche e pratiche. Dal punto di vista utilitaristico, offre il vantaggio di avere un'affilatura cava e poco profonda vicino alla punta ed una parte più spessa vicino al manico.

Compound sharpening is a relatively new and trendy style of blade finishing, combining two different types on the same blade for aesthetic and practical reasons. From a utilitarian point of view, it offers the advantage of having a hollow, shallow sharpening near the tip and a thicker part near the handle.

### AFFILATURA SCANDI

#### SCANDI GRIND

L'affilatura scandinava consiste in un singolo bisello acuto che finisce a 0 gradi. Questo tipo di affilatura garantisce che gli smussi superiori e inferiori convergano esattamente al centro, creando un bordo ben definito lungo tutta la lunghezza della parte affilata. A differenza di un'affilatura completa della lama che si estende fino al dorso, questo design limita i lati affilati al punto centrale della lama. Il risultato è una lama robusta e durevole, facile da affilare e da mantenere.

Scandinavian sharpening consists of a single acute bevel that ends at 0 degrees. This type of sharpening ensures that the top and bottom bevels converge exactly in the center, creating a well-defined edge along the entire length of the sharpened part. Unlike a full blade sharpening that extends to the back, this design limits the sharpened sides to the center point of the blade. The result is a strong and durable blade that is easy to sharpen and maintain.

### AFFILATURA CONVESSA

#### CONVEX GRIND

A differenza dell'affilatura concava, che si incurva verso l'interno, l'affilatura convessa presenta curve arrotondate che convergono sulla punta. I coltelli con affilatura convessa hanno un filo particolarmente robusto, ideale per il taglio. Tuttavia, la sua realizzazione e manutenzione risultano complesse, rendendo questi coltelli rari e specifici per usi specializzati.

Different from the Hollow Grind, which curves inward, the Convex Grind has rounded curves that converge at the tip. Knives with Convex sharpening have a particularly strong edge that is ideal for cutting. However, its manufacture and maintenance are complex, making these knives rare and specific for specialized uses.

### AFFILATURA A SCALPELLO

#### CHISEL GRIND

L'affilatura a scalpello risulta asimmetrica e conferisce alla lama un angolo di circa 20-30 gradi su un solo lato della lama. Come suggerisce il nome, questo tipo di affilatura cerca di imitare quella di un vero e proprio scalpello, ma sotto forma di lama di coltello.

Chisel sharpening is asymmetrical and gives the blade an angle of about 20-30 degrees on one side of the blade only. As the name suggests, this type of sharpening attempts to mimic that of a real chisel, but in the form of a knife blade.

Le principali - The main

# TIPOLOGIE DI LAMA

## TYPES OF BLADE

### CLIP POINT

La lama Clip Point, nota anche come coltello Bowie, è caratterizzata da un dorso che si stacca direttamente dal manico prima di scendere bruscamente a una punta sottile, quasi come se una parte della lama fosse stata tagliata via. Questo stile di lama è stato popolare tra i cacciatori e gli amanti della vita all'aria aperta americani per decenni, dimostrando di essere una lama affidabile adatta a un'ampia gamma di compiti.

The Clip Point blade, also known as the Bowie knife, is characterized by a back that comes straight off the handle before abruptly descending to a thin point, almost as if part of the blade had been cut away. This style of blade has been popular with American hunters and outdoorsmen for decades, proving to be a reliable blade suitable for a wide range of tasks.



### DROP POINT

La lama Drop Point è caratterizzata da una forma distintiva in cui il dorso della lama si curva gradualmente verso il filo di taglio formando una punta leggermente abbassata rispetto alla linea del dorso. Questa lama ha diversi vantaggi: la sua punta robusta e resistente la rende ideale per attività che richiedono forza e penetrazione.

The Drop Point blade is characterized by a distinctive shape in which the back of the blade gradually curves toward the cutting edge, forming a point slightly lowered from the line of the back. This blade has several advantages: its strong and durable tip makes it ideal for tasks that require strength and penetration.



### TANTO

La lama Tanto risalire all'antico Giappone, dove il termine "Tanto" significa letteralmente "spada corta". Questo tipo di lama ha una forma unica, con una punta robusta e una curvatura verso l'estremità. È nota per la sua versatilità e capacità di tagliare, forare e penetrare con precisione. Inizialmente concepita come arma di difesa personale, la lama Tanto divenne presto un simbolo di potere e prestigio nella cultura giapponese, utilizzata anche come status symbol dai samurai.

The Tanto blade dates back to ancient Japan, where the term "Tanto" literally means "short sword." This type of blade has a unique shape, with a strong tip and a curvature toward the end. It is known for its versatility and ability to cut, pierce and penetrate with precision. Initially conceived as a personal defense weapon, the Tanto blade soon became a symbol of power and prestige in Japanese culture, also used as a status symbol by the samurai.



### NORMAL STRAIGHT

La lama Normal straight rappresenta una delle forme più semplici e classiche tra le lame dei coltelli, contraddistinta da un dorso rettilineo che la rende semplice ma robusta. La sua caratteristica distintiva risiede nel fatto che il dorso della lama è privo di curve o inclinazioni, mantenendo una forma semplice che favorisce la resistenza e la facilità di fabbricazione. Questa semplicità la rende una scelta ampiamente diffusa per diversi scopi applicativi.

The Normal straight blade represents one of the simplest and most classic shapes among knife blades, distinguished by a straight back that makes it simple yet sturdy. Its distinguishing feature lies in the fact that the back of the blade is free of curves or inclines, maintaining a simple shape that promotes strength and ease of manufacture. This simplicity makes it a widely used choice for various application purposes.



### SHEEPFOOT

La lama Sheepfoot è un tipo di lama utilizzata principalmente sui coltelli da lavoro e da utilità. Si caratterizza per la sua forma piatta e arrotondata, senza punta affilata. È caratterizzata da un dorso dritto che si estende parallelamente al filo di taglio, creando un profilo rettilineo. Il filo di taglio è piatto e si estende orizzontalmente fino all'estremità della lama. Questo design rende la lama molto stabile e sicura durante l'uso, poiché riduce il rischio di punzecchiature o lesioni accidentali.

The Sheepfoot blade is a type of blade used primarily on utility and work knives. It is characterized by its flat, rounded shape with no sharp point. It is characterized by a straight back that extends parallel to the cutting edge, creating a straight profile. The cutting edge is flat and extends horizontally to the end of the blade. This design makes the blade very stable and safe during use, as it reduces the risk of accidental poking or injury.



### SHILIN

La lama Shilin è un tipo di lama ispirata alla tradizione artigianale cinese. Originaria della regione di Shilin, questa lama si distingue per una discreta pancia graduale e la punta rivolta verso il basso. Pensata per combinare estetica e praticità, è ideale per una varietà di compiti quotidiani.

The Shilin blade is a type of blade inspired by traditional Chinese craftsmanship. Originating in the Shilin region, this blade is distinguished by a discreet gradual belly and downward-pointing tip. Designed to combine aesthetics and practicality, it is ideal for a variety of everyday tasks.



### KARAMBIT

Il Karambit è un coltello realizzato a forma di artiglio. La lama, originariamente si ispira all'artiglio della tigre di Sumatra, era utilizzata inizialmente per l'agricoltura ed il settore tessile. Quando venne esportata fuori dall'Indonesia assunse la funzione di autodifesa e combattimento. Viene impugnato con la lama rivolta verso il basso dalla base del pugno, curvata in avanti. Sono lame utilizzate in tempi moderni per autodifesa o per attività che richiedono movimenti di trazione.

The Karambit is a knife made in the shape of a claw. The blade, originally inspired by the Sumatran tiger's claw, was initially used for agriculture and textiles. When it was exported out of Indonesia it took on the function of self-defense and combat. It is wielded with the blade facing downward from the base of the fist, curved forward. These are blades used in modern times for self-defense or for activities that require pulling movements.



### POINT DAGGER

La lama Point Dagger è caratterizzata da un doppio filo affilato, con entrambi i bordi che si incontrano e si allineano nella parte centrale della lama, consentendo il taglio in entrambe le direzioni. La simmetria di questa lama la rende particolarmente adatta a chi cerca uno strumento bilanciato e preciso.

The Point Dagger blade features a sharp double edge, with both edges meeting and aligning in the central part of the blade, allowing cutting in either direction. The symmetry of this blade makes it particularly suitable for those seeking a balanced and precise tool.



### GUT HOOK

La Gut Hook o lama ad "uncino" presenta un gancio sul dorso, dietro alla punta della lama e con l'uncino verso il manico. I bordi affilati all'interno dell'uncino sono indicati per il taglio di lenze, corde e cinture. Sono usate soprattutto nella caccia e nella pesca.

The Gut Hook or "hook" blade features a hook on the back, behind the tip of the blade and with the hook toward the handle. The sharp edges inside the hook are suitable for cutting fishing line, ropes and belts. They are used mainly in hunting and fishing.



### KUKRI

La lama Kukri ha origini in Nepal e, successivamente, è stata adottata come arma da combattimento nelle forze armate asiatiche. Per il mondo occidentale, rappresenta una lama relativamente recente, divenendo principalmente un oggetto da collezione piuttosto che uno strumento di uso quotidiano. Tuttavia, la sua utilità è notevole in ambito agricolo. La caratteristica principale della lama Kukri è la sua curvatura, che si amplia verso l'estremità e si restringe verso la punta, conferendole un aspetto simile a una mezzaluna.

The Kukri blade has its origins in Nepal and was later adopted as a combat weapon in the Asian armed forces. To the Western world, it represents a relatively recent blade, becoming primarily a collector's item rather than an everyday tool. However, its utility is considerable in the agricultural field. The main characteristic of the Kukri blade is its curvature, which widens toward the end and narrows toward the tip, giving it a crescent-like appearance.



I **principali** - The main

# MECCANISMI DI APERTURA

## OPENING MECHANISMS

### FLIPPER

Riconosciuto come uno dei metodi di apertura più efficaci, il sistema flipper è veloce, affidabile e semplice da usare. Una linguetta sporgente verso l'esterno e consente di estrarre rapidamente il filo tagliente applicando su di essa un po' di pressione. L'unicità del Flipper risiede nel suo meccanismo di movimento, che richiede un perno adeguatamente oliato o dotato di cuscinetti a sfera per funzionare al meglio.

Recognized as one of the most effective opening methods, the flipper system is fast, reliable, and easy to use. A tab protrudes outward and allows the sharp wire to be quickly pulled out by applying a little pressure on it. The uniqueness of the Flipper lies in its movement mechanism, which requires a properly oiled or ball-bearing pivot to work at its best.

### THUMB STUD - THUMB HOLE - THUMB DISK

Queste tre modalità di apertura condividono lo stesso principio: consentono di aprire la lama con il pollice. Queste aperture sono molto apprezzate per la loro praticità. Creando una leva sulla lama, permettono un’apertura fluida del coltello, con un solo gesto. Oltre al foro, anche il perno può essere posizionato su uno o entrambi i lati della lama per soddisfare sia mancini che destrorsi; alcuni modelli hanno un perno sul dorso.

These three opening modes share the same principle: they allow the blade to be opened with the thumb. These openings are highly valued for their convenience. By creating a lever on the blade, they allow a smooth opening of the knife, with a single gesture. In addition to the hole, the pin can also be placed on one or both sides of the blade to satisfy both left and right handed people; some models have a pin on the back.

### INCAVO PER UNGHIE

### NAIL NICK OPENER

Questo è il più classico degli apribili, dove gli incavi per le unghie incarnano tradizione e sobrietà. Si presenta come una piccola fessura nella lama del coltello, spesso abbinata a un sistema slip joint. Non è il sistema più immediato, ma questo incavo promuove un’apertura consapevole, spesso necessitando dell’uso di entrambe le mani.

This is the most classic of openers, where nail recesses embody tradition and restraint. It takes the form of a small slot in the knife blade, often combined with a slip joint system. It is not the most straightforward system, but this hollow promotes deliberate opening, often requiring the use of both hands.

### EMERSON WAVE

L'Emerson Wave è un sistema di apertura brevettato che si distingue per la forma a onda situata sul dorso della lama. L'Emerson "Wave Shaped Feature", chiamato anche "remote pocket opener", consente di aprire il coltello mentre viene estratto dalla tasca. Ciò rende qualsiasi coltello Emerson dotato di questa funzione un coltello pieghevole molto veloce.

The Emerson Wave is a patented opening system distinguished by a wave shape located on the back of the blade. The Emerson "Wave Shaped Feature," also called the "remote pocket opener," allows the knife to be opened as it is pulled out of the pocket. This makes any Emerson knife with this feature a very fast folding knife.

### AUTOMATICO

### AUTOMATIC

Un coltello automatico, o switchblade, è un coltello la cui lama si apre rapidamente premendo un pulsante grazie a un meccanismo a molla. Tra i vantaggi principali troviamo la rapidità, con un’apertura quasi istantanea, e la facilità d’uso, poiché richiede uno sforzo minimo. Tuttavia, in Italia, i coltelli automatici il loro acquisto o detenzione è consentito solo dietro presentazione di un Porto d’Armi o di un Permesso d’Acquisto rilasciato dalla Questura

An automatic knife, or switchblade, is a knife whose blade is quickly opened by pressing a button thanks to a spring-loaded mechanism. The main advantages include speed, with almost instantaneous opening, and ease of use, since it requires minimal effort. However, in Italy, automatic knives their purchase or possession is allowed only upon presentation of a Porto d’Armi or a Permesso d’Acquisto issued by the Questura. In addition, reliability can be an issue, as the springs tend to weaken or break over time.

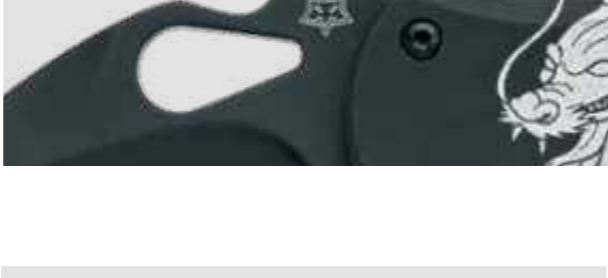
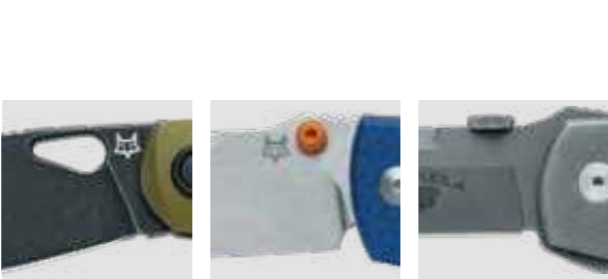

I **principali** - The main

# MECCANISMI DI BLOCCO

## LOCKING MECHANISMS

#### LINER LOCK

Nel liner lock la struttura portante è costituita da due cartelle in metallo, su cui sono fissate le guancette. La cartella destra è tagliata in modo da ricavare una molla a lamina la cui parte frontale, a coltello aperto, va a inserirsi dietro al tallone della lama, impedendone la chiusura. Per sbloccare e chiudere la lama, è sufficiente agire con il dito pollice sul liner-lock e accompagnarla in chiusura all'interno del manico. A volte la cartella sinistra può non essere presente.

The supporting structure of the liner- ock is made of two liners to which the scales are clipped. The right sided liner is cut to obtain a laminated spring that butts up against the tang of the blade when the knife is in the opened position. That prevents the knife from closing. To unlock and close the blade, simply act with your thumb finger on the liner-lock and accompany it in closing inside the handle. Sometimes the left folder may not be present.

#### FRAME LOCK

Simile al liner lock, nella struttura frame lock cartella e guancetta coincidono. La molla è quindi tagliata direttamente nella guancetta destra. Nei coltelli di grandi dimensioni questa è solitamente realizzata in titanio per contenere il peso finale. Per la chiusura si opera direttamente sulla molla, riportandola in posizione di riposo e svincolando il tagliente.

The supporting structure of the liner lock is made of two liners to which the scales are clipped. The right sided liner is cut to obtain a laminated spring that butts up against the tang of the blade when the knife is in the opened position. That prevents the knife from closing. To release the lock the user must action the lockbar with his thumb.

#### BACK LOCK

Il sistema back lock è uno dei più robusti e classici. Tutti i sistemi di blocco a pompa si basano su una leva, con una sporgenza che si aggancia in un recesso ricavato sulla parte superiore del tallone della lama. Tale leva è spinta in posizione da una molla, tradizionalmente solidale allo spaziatore posteriore. Per chiudere il coltello si abbassa la parte posteriore della leva, premendo con il pollice a volte in coda al coltello, altre volte a metà del dorso del manico.

The back lock system is one of the most robust and classic systems. All pump lock systems are based on a lever, with a protrusion that engages in a recess cut into the top of the blade heel. This lever is pushed into position by a spring, traditionally integral to the rear spacer. To close the knife, the back of the lever is lowered, pressing down with the thumb sometimes at the tail of the knife, sometimes at the middle of the back of the handle.

#### SLIP JOINT

I coltelli slip joint non hanno un vero e proprio blocco, ma solamente un sistema che oppone una certa resistenza alla chiusura della lama, vinta la quale, la stessa è libera di andare in chiusura. Solitamente, l'elemento elastico che contrasta il movimento della lama consiste in una molla dorsale, simile a quella utilizzata sui back-lock, da cui si distingue per l'assenza del dente deputato ad agganciare la lama. Per chiudere uno slip joint, basta premere sul dorso della lama fino a vincere la resistenza della molla.

Slip-joint knives do not have a real lock, but only a system that opposes a certain resistance to the closing of the blade, overcoming which, the blade is free to go into lock. Usually, the elastic element that counteracts the movement of the blade consists of a back spring, similar to that used on back-locks, from which it differs by the absence of the tooth deputed to engage the blade. To close a slip joint, simply press down on the back of the blade until the resistance of the spring is overcome.

#### FRICITION FOLDER

I coltelli friction folder non utilizzano un vero e proprio meccanismo di bloccaggio per mantenere la lama in posizione aperta. Il meccanismo si basa sull'attrito tra la lama e il manico per rimanere aperto. Il coltello ha una spina che sporge dalla parte posteriore della lama quando è aperto. Quando si impugna il coltello, la mano esercita una pressione sulla spina, mantenendo la lama in posizione grazie all'attrito.

Friction Folder knives do not use an actual locking mechanism to hold the blade in the open position. The mechanism relies on the friction between the blade and the handle to stay open. The knife has a pin that protrudes from the back of the blade when it is open. When holding the knife, the hand exerts pressure on the pin, keeping the blade in place through friction.

#### BUTTON LOCK

Il blocco è controllato da un pulsante, spesso posizionato sul manico del coltello. Quando si apre completamente la lama, un perno o una linguetta, controllati da un pulsante sul manico, si posizionano in una scanalatura sulla lama, bloccandola in posizione aperta. Per chiudere il coltello, è sufficiente premere il pulsante, il quale ritira il perno o la linguetta, permettendo alla lama di ripiegarsi nel manico. L'azione di bloccaggio quindi è completamente indipendente dall'impugnatura.

the lock is controlled by a button, often located on the handle of the knife. When the blade is fully opened, a pin or tab, controlled by a button on the handle, sits in a groove on the blade, locking it in the open position. To close the knife, simply press the button, which withdraws the pin or tab, allowing the blade to fold back into the handle. The locking action then is completely independent of the handle.

#### RADIUS LOCK

L'innovativo Radius lock è un sistema brevettato Fingers Safe Opening System. Il meccanismo di rotazione è azionato da un pulsante montato a portata di pollice. Un perno è incastonato in una scanalatura che gira intorno alla metà superiore della vite. Quando l'utente spinge il perno lungo l'apposita corsia, la lama si apre e si blocca in posizione. Ripetendo la procedura al contrario, la lama torna nella posizione di chiusura.

The innovative Fox Radius features a new opening mechanism, the patented Fingers Safe Opening System. The turning mechanism is operated by a thumb-mounted button. A pin is set in a groove that goes around the top half of the screw. When the user pushes the pin along the appropriate lane, the blade opens and locks in place. By repeating the procedure in reverse, the blade returns to the closed position.

#### SAFE SYSTEM LOCK® (A.S.L.S.)

Con il sistema Automatic SAFE SYSTEM LOCK®, (A.S.L.S.) Viper fa un passo in avanti nella sicurezza. Questo sistema è l'unico che consente di aprire e chiudere il coltello con una sola mano, rendendo l'operazione pratica e veloce. Il sistema A.S.L.S. brevettato ha il blocco automatico della lama durante l'apertura, garantendo maggiore affidabilità e sicurezza. Il meccanismo si trova sul liner dove il pollice si appoggia naturalmente, permettendo di disinserire il blocco con un semplice movimento del dito.

The innovative Fox Radius features a new opening mechanism, the patented Fingers Safe Opening System. The turning mechanism is operated by a thumb-mounted button. A pin is set in a groove that goes around the top half of the screw. When the user pushes the pin along the appropriate lane, the blade opens and locks in place. By repeating the procedure in reverse, the blade returns to the closed position.

Le principali - The main

# TIPOLOGIE DI MANICI

## TYPES OF HANDLES

### TITANIO

#### TITANIUM

Il titanio è un metallo leggero e non ferroso con un'eccezionale resistenza alla corrosione e un'impressionante forza di trazione. Le sue proprietà lo rendono un materiale ideale non solo per i manici, ma anche per altri componenti.

Titanium is a lightweight, nonferrous metal with exceptional corrosion resistance and impressive tensile strength. Its properties make it an ideal material not only for handles but also for other components.



### ALLUMINIO

#### ALUMINIUM

L'alluminio è molto apprezzato per la combinazione di leggerezza e resistenza. La sua superficie, liscia e piacevole al tatto, conferisce al coltello un aspetto moderno ed elegante. Inoltre, attraverso il processo di anodizzazione, è possibile ottenere un rivestimento in diverse tonalità.

Aluminum is prized for its lightness and strength. Its smooth, pleasing to the touch surface adds a touch of modernity and elegance to the knife's overall design. Aluminum is also anodized to create a coating of various colors.



### FRN

Il FRN è un polimero di nylon rinforzato con fibra di vetro, progettato per lo stampaggio a iniezione. Questo materiale, leggero ma altamente resistente, è ideale per realizzare manici di coltello con forme sagomate e texture.

FRN is a fiberglass reinforced nylon polymer designed for injection molding. This lightweight yet highly durable material is ideal for making knife handles with contoured shapes and textures.

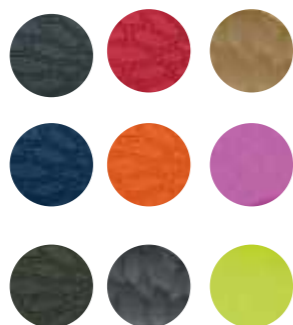

### MATERIALI NATURALI

#### NATURAL MATERIALS

Materiali naturali come ad esempio il corno, legno, radica sono ideali per la creazione e la decorazione dei manici. Questi elementi naturali possono essere trattati e lavorati per garantire resistenza e durata.

Natural materials such as horn, wood, root are ideal for creating and decorating handles. These natural elements can be treated and processed for strength and durability.



### FIBRA DI CARBONIO

#### CARBON FIBER

Nella fibra di carbonio, le fibre di grafite sono intrecciate e legate con resina epossidica, creando un materiale leggero noto per la sua eccezionale resistenza alla trazione. Questo materiale ha un aspetto tridimensionale di grande effetto.

In carbon fiber, graphite fibers are woven and bonded with epoxy resin, creating a lightweight material known for its exceptional tensile strength. This material has a striking three-dimensional appearance.



### MICARTA

La Micarta è un composto di lino, tela o carta che viene impregnato con resina epossidica e formato in fogli o blocchi. È leggero, leggero, resistente e di grande impatto visivo. Può essere lucidato o sabbato per produrre diversi aspetti e texture.

Micarta is a composite of linen, canvas, or paper that is impregnated with epoxy resin and formed into sheets or blocks. It is lightweight, durable, and visually appealing. It can be polished or bead blasted to produce different appearances and textures.

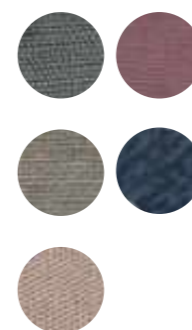

### G10

Il G10 è un materiale realizzato in fibra di vetro intrecciata e riempita con resina epossidica. Questo materiale è rigido, resistente alle variazioni di temperatura e agli agenti chimici ed offre anche la possibilità di essere colorato in diverse tonalità.

G10 is a material made of woven fiberglass filled with epoxy resin. This material is rigid, resistant to temperature changes and chemicals, and also offers the possibility of being colored in different shades.



### ALTRI MATERIALI

#### OTHER MATERIALS

Ogni materiale è selezionato per la sua qualità ed il suo impatto visivo, garantendo che ogni coltello sia non solo uno strumento funzionale, ma anche un pezzo d'arte da collezione. Timasco, malachite, madreperla sono alcuni dei materiali speciali che abbiamo selezionato per i nostri coltelli.

Each material is selected for its quality and visual impact, ensuring that each knife is not only a functional tool but also a collectible piece of art. Timascus, malachite, and mother of pearl are some of the special materials we have selected for our knives.



# TIPOLOGIE DI CLIP

## TYPES OF CLIPS



### CLIP TRADIZIONALE

#### TRADITIONAL CLIP

Sono le clip più utilizzate e possono essere realizzate in acciaio inossidabile, in titanio o in altri materiali robusti. Variano per forma, dimensione e finitura per adattarsi ai vari design. Possono essere fissate al manico con viti o bulloni e spesso possono essere regolate o spostate per offrire diverse opzioni di trasporto.

They are the most commonly used clips and can be made of stainless steel, titanium, or other sturdy materials. They vary in shape, size, and finish to fit various designs. They can be attached to the handle with screws or bolts and can often be adjusted or moved to provide different carrying options.

### CLIP DA TASCA PROFONDA

#### DEEP POCKET CLIP

La caratteristica principale delle clip da tasca profonda è il loro design, che consente al coltello di rimanere completamente o quasi completamente nascosto all'interno della tasca. La parte superiore del coltello, infatti, rimane allineata o appena sotto il bordo della tasca, esponendo solamente la clip stessa.

The main feature of deep pocket clips is their design, which allows the knife to remain completely or almost completely hidden inside the pocket. In fact, the top of the knife remains aligned with or just below the edge of the pocket, exposing only the clip itself.



### CLIP A FILO

#### WIRE CLIP

Il termine "a filo" si riferisce alla loro struttura sottile e discreta, che si adatta al profilo del coltello senza sporgere in modo eccessivo, mantenendo un design minimalista e funzionale. Sono spesso realizzate in acciaio inox per garantire leggerezza, durabilità e resistenza alla corrosione. La forma compatta evita che il coltello sia troppo visibile o scomodo da trasportare e possono essere fissate in diverse posizioni sul manico, offrendo opzioni per un trasporto in posizione tip-up o tip-down.

The term "wire clip" refers to their subtle and unobtrusive construction, which fits the profile of the knife without protruding excessively, maintaining a minimalist and functional design. They are often made of stainless steel to ensure lightness, durability and resistance to corrosion. The compact shape prevents the knife from being too visible or awkward to carry, and they can be attached in different positions on the handle, providing options for tip-up or tip-down carrying.

# COME MODIFICARE LA POSIZIONE DELLA CLIP

## HOW TO CHANGE THE POSITION OF THE CLIP

Offriamo un'ampia selezione di coltelli dotati di clip reversibile, progettati per soddisfare diverse esigenze. Alcuni modelli permettono l'installazione e il fissaggio della clip su entrambi i lati del coltello, mentre altri consentono di orientarla sia a destra sia a sinistra sul medesimo lato. Si raccomanda ai clienti di utilizzare esclusivamente viti e clip nuove e compatibili con il modello scelto, al fine di prevenire il rischio di allentamento delle viti o un fissaggio instabile della clip.

We offer a wide selection of knives equipped with reversible clips, designed to meet different needs. Some models allow the clip to be installed and attached on both sides of the knife, while others allow it to be oriented either to the right or left on the same side. Customers are advised to use only new screws and clips that are compatible with the chosen model in order to prevent the risk of screw loosening or unstable clip attachment.

### COSA TI SERVE

#### WHAT YOU NEED

Prima di iniziare è consigliabile preparare tutti gli strumenti che ti serviranno per questa operazione come cacciaviti della giusta misura e forma, chiavi inglesi appropriate e dell'olio frena filetti. Gli esatti strumenti che ti serviranno dipendono anche dal tipo di modello di clip che vuoi configurare. Consigliamo anche di posizionarsi sotto una buona fonte di luce, per vedere nel dettaglio le componenti della clip e facilitarne le operazioni di mono e smonto.

Before you begin, it is advisable to prepare all the tools you will need for this operation such as screwdrivers of the right size and shape, appropriate wrenches, and some threadlocking oil. The exact tools you will need also depend on the type of clip pattern you want to set up. We also recommend that you position yourself under a good light source so that you can see the components of the clip in detail and make it easier to mono and disassemble.

### CAMBIO DELLE CLIP CON VITE

#### CHANGING CLIPS WITH SCREW

Per modificare le clip unite al manico tramite viti è necessario posizionarsi su un asciugamano o su un tappetino con aderenza in una superficie piana e solida per impedire al coltello di muoversi e ruotare. Lavorate sempre sul coltello con lama chiusa. Inserite il cacciavite e con una pressione decisa allentate la vite che tiene la clip. La pressione deve essere costante e verso il basso per evitare di spanare la testa della vite. Procedere in questo modo per tutte le viti, lasciandole allentate nei fori. Sollevate la clip e le viti ancora inserite tutte insieme, facendo pressione con un dito per evitare di farle cadere. È consigliabile utilizzare un olio frena-filetti sulla filettatura di ogni vite quindi allineare la clip e le viti con i fori dell'impugnatura nella posizione desiderata. Con il coltello posizionato sul piano ruotare la vite centrale finché non si innesta. In questo modo la clip viene allineata e l'installazione è facilitata. Girate tutte le viti fino a farle aderire.

To modify the clips joined to the handle by screws, it is necessary to stand on a towel or mat with grip on a flat, firm surface to prevent the knife from moving and rotating. Always work on the knife with the blade closed. Insert the screwdriver and with firm pressure loosen the screw holding the clip. The pressure should be steady and downward to avoid stripping the screw head. Proceed in this way for all screws, leaving them loose in the holes. Lift the clip and still insert screws all together, applying pressure with a finger to avoid dropping them. You may want to use threadlocking oil on the threads of each screw then align the clip and screws with the handle holes in the desired position. With the knife positioned on the plane rotate the center screw until it engages. This aligns the clip and facilitates installation. Turn all the screws until they fit.

### CAMBIO DELLE CLIP A FILO

#### CHANGING WIRE CLIPS

Per modificare la posizione delle clip a filo basterà eseguire le stesse procedure descritte precedentemente. In questo caso potrebbe essere utile fare pressione con il dito sul lato posteriore del coltello per evitare che la vite si giri nel processo di rimozione della vite. Una volta allentata la vite di qualche giro (non è necessario rimuoverla completamente) sollevare la clip e rimuoverla dalle scanalature nel manico. Spingere la testa della vite verso il basso e girare il coltello sul fianco opposto. Inserire il fermaglio sotto la testa della vite e stringere la vite per tenere la clip in posizione.

To change the position of the flush clips, simply perform the same procedures as described above. In this case it may be helpful to apply pressure with your finger on the back side of the knife to prevent the screw from turning in the process of removing it. Once you have loosened the screw a few turns (it is not necessary to remove them completely) lift the clip and remove it from the grooves in the handle. Push the screw head down and turn the knife on its opposite side. Insert the clip under the screw head and tighten the screw to hold the clip in place.





## **COLTELLI CHIUDIBILI** **FOLDING KNIVES**

La categoria dei coltelli chiudibili è la più scelta dagli appassionati considerate le dimensioni ridotte e il facile porto grazie ai diversi foderi in dotazione per alcuni modelli. Con diversi meccanismi di apertura, questa categoria offre un'ampia gamma di articoli dai materiali di prima qualità ricercati con passione dai più noti designers del settore e dal Fox Knives Team con particolare attenzione e cura per i dettagli. I coltelli Fox Knives sono prodotti Made in Italy.

The folding knife category is the most popular choice among enthusiasts considering the small size and easy carry due to the different sheaths provided for some models. With different opening mechanisms, this category offers a wide range of items from the highest quality materials passionately researched by the industry's best-known designers and the Fox Knives Team with special attention and care for details. Fox Knives are Made in Italy products.

# FX-556 METAMORPHOSIS



WINNER 23

EUROPEAN  
PRODUCT  
DESIGN  
AWARD



FOX KNIVES



ON - LIMITED EDITION - LIMA

## FX-556-A1 RADIUS LOCK



### LAMA | BLADE

Super Dense Twist™ by Damasteel®  
HRC 59-61

### MANICO | HANDLE

Titanio PVD nero + mostrine in Timasco  
Black PVD titanium + Timascus bolsters

### RADIUS LOCK

AISI 303 PVD nero  
Black PVD AISI 303

▼  
Movimento con cuscinetti a sfera  
Ball bearing operating system

### DISTANZIALE | SPACER

Fibra di carbonio 3K  
3K carbon fiber

### CLIP

Sagomata in AISI 420 PVD nero  
Black PVD shaped AISI 420

### VITI | SCREWS

AISI 303 PVD nero  
Black PVD AISI 303



Scatola + fodero in cuoio nero  
Box + black leather sheath



ON - LIMITED EDITION - LIMA

## FX-556-B1 RADIUS LOCK



### LAMA | BALDE

Super Dense Twist™ by Damasteel®  
HRC 59-61

### MANICO | HANDLE

Fibra di carbonio 3K + mostrine titanio anodizzato blu  
3K carbon fiber + blue anodized titanium bolsters

### RADIUS LOCK

Titanio anodizzato blu  
Blue anodized titanium

▼  
Movimento con cuscinetti a sfera  
Ball bearing operating system

### DISTANZIALE | SPACER

Titanio anodizzato blu  
Blue anodized titanium

### CLIP

Sagomata in AISI 420 PVD nero  
Black PVD shaped AISI 420

### VITI | SCREWS

Titanio anodizzato blu  
Blue anodized titanium



Scatola + fodero in cuoio nero  
Box + black leather sheath



# FX-556 METAMORPHOSIS

designed by Fox Knives Team

Al cuore di questo straordinario coltello si trova il sistema Radius, un'innovazione senza eguali che unisce sicurezza e praticità dei movimenti. Il Metamorphosis, a differenza del suo predecessore Radius, è dotato di un flipper che aggiunge un elemento fidget, trasformando l'utilizzo del coltello in un'esperienza coinvolgente e divertente. Sia che si tratti di esplorare la creatività o affrontare le sfide quotidiane, il Metamorphosis è un compagno affidabile e personalizzabile che si adatta al tuo stile di vita. Rinnova la tua esperienza coltellistica con il Metamorphosis di Fox Knives.

At the heart of this extraordinary knife is the Radius system, an unparalleled innovation that combines safety and practicality of movement. The Metamorphosis, unlike its Radius predecessor, features a pinball machine that adds a fidget element, turning the use of the knife into an engaging and fun experience.

Whether exploring creativity or facing daily challenges, the Metamorphosis is a reliable and customizable companion that fits your lifestyle.

Renew your knife experience with the Metamorphosis from Fox Knives.



Nylon® + patch  
Metamorphosis  
Nylon® + Metamorphosis  
patch

135 gr - 4,76 oz

## FX-556-A2 RADIUS LOCK

Movimento con cuscinetti a sfera  
Ball bearing operating system



20 cm - 7,67"



4 mm - 0,16"



8,5 cm - 3,35"



M390 PVD nero  
Black PVD M390  
HRC 59-61



Micarta nera sabbiata + mostrine  
in titanio PVD nero  
Sandblasted black Micarta +  
black PVD titanium bolsters



AISI 303 PVD nero  
Black PVD AISI 303



Titanio PVD nero  
Black PVD titanium



Sagomata in AISI 420 PVD nero  
Black PVD shaped AISI 420



AISI 303 PVD nero  
Black PVD AISI 303



Nylon® + patch  
Metamorphosis  
Nylon® + Metamorphosis  
patch

125 gr - 4,40 oz

## FX-556-A4 RADIUS LOCK

Movimento con cuscinetti a sfera  
Ball bearing operating system



20 cm - 7,67"



4 mm - 0,16"



8,5 cm - 3,35"



M390 PVD nero  
Black PVD M390  
HRC 59-61



Fibra di carbonio 3K +  
mostrine in titanio PVD nero  
3K carbon fiber + black PVD  
titanium bolsters



AISI 303 PVD nero  
Black PVD AISI 303



Titanio PVD nero  
Black PVD titanium



Sagomata in AISI 420 PVD nero  
Black PVD shaped AISI 420



AISI 303 PVD nero  
Black PVD AISI 303



Nylon® + patch  
Metamorphosis  
Nylon® + Metamorphosis  
patch

155 gr - 5,46 oz

## FX-556-B4 RADIUS LOCK

Movimento con cuscinetti a sfera  
Ball bearing operating system



20 cm - 7,67"



4 mm - 0,16"



8,5 cm - 3,35"



M390 acid stone washed  
Acid stone washed M390  
HRC 59-61



Micarta verde sabbiata +  
mostrine in ottone stone washed  
Sandblasted green Micarta +  
stone washed brass bolsters



AISI 303 sabbiato  
Sandblasted AISI 303



Ottone stone washed  
Stone washed brass



Sagomata AISI 420 sabbiato  
Sandblasted shaped AISI 420



AISI 303 sabbiato  
Sandblasted AISI 303



Nylon® + patch  
Metamorphosis  
Nylon® + Metamorphosis  
patch

125 gr - 4,40 oz

## FX-556-B5 RADIUS LOCK

Movimento con cuscinetti a sfera  
Ball bearing operating system



20 cm - 7,67"



4 mm - 0,16"



8,5 cm - 3,35"



M390 satinato  
Satin M390  
HRC 59-61



Alluminio anodizzato verde OD +  
mostrine in allum. anodizzato arancione  
OD green anodized aluminium + orange  
anodized alum. bolsters



AISI 303 lucido  
Polished AISI 303



Alluminio anodizzato arancione  
Orange anodized aluminium



Sagomata AISI 420 lucido  
Polished shaped AISI 420



AISI 303 lucido  
Polished AISI 303



Nylon® + patch  
Metamorphosis  
Nylon® + Metamorphosis  
patch

135 gr - 4,76 oz

## FX-556-B6 RADIUS LOCK

Movimento con cuscinetti a sfera  
Ball bearing operating system



20 cm - 7,67"



4 mm - 0,16"



8,5 cm - 3,35"



M390 PVD nero  
Black PVD M390  
HRC 59-61



Alluminio anodizzato nero + mostrine  
in allum. anodizzato arancione  
Black anodized aluminium + orange  
anodized alum. bolsters



AISI 303 PVD nero  
Black PVD AISI 303



Alluminio anodizzato arancione  
Orange anodized aluminium



Sagomata in AISI 420 PVD nero  
Black PVD shaped AISI 420



AISI 303 PVD nero  
Black PVD AISI 303

# FX-555 JUPITER

designed by Anarcnide



## FX-555 DPB RADIUS LOCK



**LAMA | BLADE**  
Hakkapella™ Damascus by  
Damasteel®  
HRC 59-60

**MANICO | HANDLE**  
Titanio sabbaiato + timasco  
Sandblasted titanium + timascus

**RADIUS LOCK**  
Titanio anodizzato rosa  
Pink anodized titanium  
▼  
Movimento con cuscinetti a sfera  
Ball bearing operating system

**DISTANZIALE | SPACER**  
Titanio sabbaiato  
Sandblasted titanium

**CLIP**  
Sagomata in titanio sabbaiato  
Sandblasted shaped titanium

**VITI | SCREWS**  
Titanio anodizzato blu  
Blue anodized titanium



## FX-555 DM RADIUS LOCK



**LAMA | BLADE**  
Hakkapella™ Damascus by  
Damasteel®  
HRC 59-60

**MANICO | HANDLE**  
Titanio PVD nero + malachite  
Black PVD titanium + malachite

**RADIUS LOCK**  
Titanio PVD nero  
Black PVD titanium  
▼  
Movimento con cuscinetti a sfera  
Ball bearing operating system

**DISTANZIALE | SPACER**  
Titanio PVD nero  
Black PVD titanium

**CLIP**  
Sagomata in titanio PVD nero  
Black PVD shaped titanium

**VITI | SCREWS**  
Titanio PVD nero  
Black PVD titanium



LIMITED EDITION

LIMITED EDITION



## FX-555 TICF RADIUS LOCK

▼  
Movimento con cuscinetti a sfera  
Ball bearing operating system

**LAMA | BLADE**  
M390 coarse stone washed  
Coarse stone washed M390  
HRC 59-61

**MANICO | HANDLE**  
Titanio sabbaiato + Jungle  
Wear by Fatcarbon®  
Sandblasted titanium +  
Jungle Wear by Fatcarbon®

**RADIUS LOCK**  
Titanio lucido  
Polished titanium

**DISTANZIALE | SPACER**  
Titanio sabbaiato  
Sandblasted titanium

**CLIP**  
Sagomata in titanio sabbaiato  
Sandblasted shaped titanium

**VITI | SCREWS**  
Titanio lucido  
Polished titanium

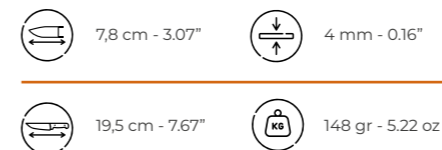

## FX-555 TIBR RADIUS LOCK

▼  
Movimento con cuscinetti a sfera  
Ball bearing operating system

**LAMA | BLADE**  
M390 PVD nero stone  
washed  
Black PVD stone washed  
M390  
HRC 59-61

**MANICO | HANDLE**  
Titanio PVD nero stone  
washed  
Black PVD stone washed  
titanium

**RADIUS LOCK**  
Titanio anodizzato bronzo  
Bronze anodized titanium

**DISTANZIALE | SPACER**  
Titanio PVD nero  
Black PVD titanium

**CLIP**  
Sagomata in titanio PVD nero  
Black PVD shaped titanium

**VITI | SCREWS**  
Titanio anodizzato bronzo  
Bronze anodized titanium

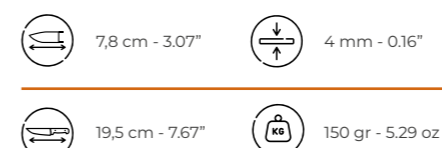

Scatola + fodero in cuoio  
sagomato  
Box + contoured leather  
sheath

Scatola + fodero in cuoio  
sagomato  
Box + contoured leather  
sheath



## FX-555 TIBL RADIUS LOCK

▼  
Movimento con cuscinetti a sfera  
Ball bearing operating system

**LAMA | BLADE**  
M390 satinato  
Satin M390  
HRC 59-61

**MANICO | HANDLE**  
Titanio PVD nero + titanio  
anodizzato blu  
Black PVD titanium + blue  
anodized titanium

**RADIUS LOCK**  
Titanio anodizzato blu  
Blue anodized titanium

**DISTANZIALE | SPACER**  
Titanio anodizzato blu  
Blue anodized titanium

**CLIP**  
Sagomata in titanio  
anodizzato blu  
Blue anodized shaped  
titanium

**VITI | SCREWS**  
Titanio anodizzato blu  
Blue anodized titanium

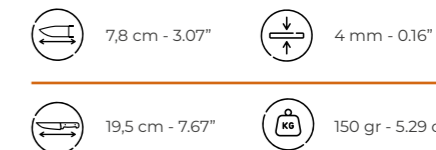

Lo Jupiter rappresenta il culmine dell'evoluzione del sistema di chiusura già utilizzato sui famosi Radius e Saturn, rispetto al quale guadagna una nuova chiusura di sicurezza che permette di inibire la rotazione della lama rotazione della lama sia in posizione aperta che chiusa, in modo che il coltello pieghevole possa affrontare lavori ancora più gravosi rispetto ai suoi illustri predecessori.

La lama, votata alla massima praticità, rende lo Jupiter il compagno ideale, sia in ambiente urbano che in quello boschivo.

The Jupiter folder represents the culmination of the evolution of the locking system already used on the wellknown famous Radius and Saturn, respect to which it gains a new safety lock that allows to inhibit the blade rotation in both open and closed position, so that the folding knife can face even more heavy-duty work than its illustrious predecessors.

The blade, devoted to maximum practicality, makes the Jupiter the ideal companion, both in urban and woodland environments.



# FX-551 SATURN

designed by Anarcnide



Fodero in cuoio sagomato /  
Contoured leather sheath



Fodero in cuoio sagomato /  
Contoured leather sheath



Nylon® + patch Saturn  
Nylon® + Saturn patch



Nylon® + patch Saturn  
Nylon® + Saturn patch

## FX-551 TiCOP RADIUS LOCK

Movimento con cuscinetti a sfera  
Ball bearing operating system



Presentato al Blade Show del 2021 è stato il vincitore dei premi Overall Knife of the Year e Imported Knife of the Year.

Il SATURN disegnato da Denis Simonutti è diventato una icona di Fox Knives, con il sistema brevettato Radius Lock, disponibile anche per mancini, che permette l'apertura e la chiusura della lama con una sola mano grazie alla pressione sul bottone che, in finale, si blocca garantendo l'utilizzo immediato. Le due guardie inoltre bloccano l'impugnatura della mano durante i lavori rendendo questo coltello sicuro.

Presented at the 2021 Blade Show, it was the winner of the Overall Knife of the Year and Imported Knife of the Year awards.

The Denis Simonutti-designed SATURN has become an icon of Fox Knives, with the patented Radius Lock system, also available for left-handed users, which allows the blade to be opened and closed with one hand by pressure on the button, which ultimately locks, ensuring immediate use. The two guards also lock the hand grip during work making this knife safe.



Packaging per il modello FX-551 TiCOP  
Packaging for FX-551 TiCOP model

Scatola + fodero in cuoio  
Box + leather sheath

## FX-551 TiPVD RADIUS LOCK

Movimento con cuscinetti a sfera  
Ball bearing operating system

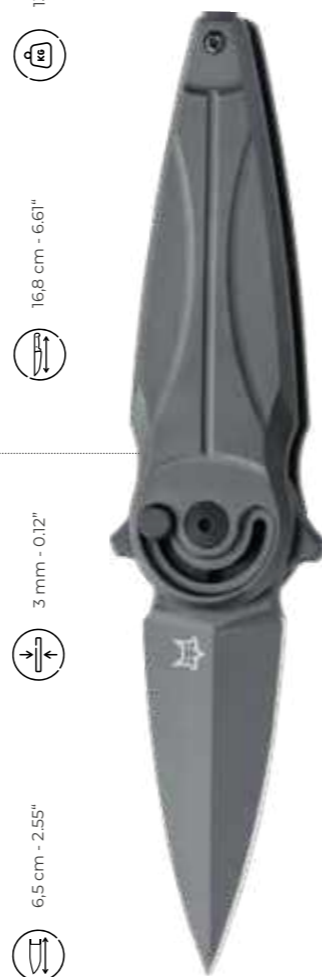

## FX-551 Ti RADIUS LOCK

Movimento con cuscinetti a sfera  
Ball bearing operating system



FX-551 SX Ti  
LEFT-HANDED

## FX-551 ALB RADIUS LOCK

Movimento con cuscinetti a sfera  
Ball bearing operating system



FX-551 SX ALB  
LEFT-HANDED

## FX-551 ALG RADIUS LOCK

Movimento con cuscinetti a sfera  
Ball bearing operating system

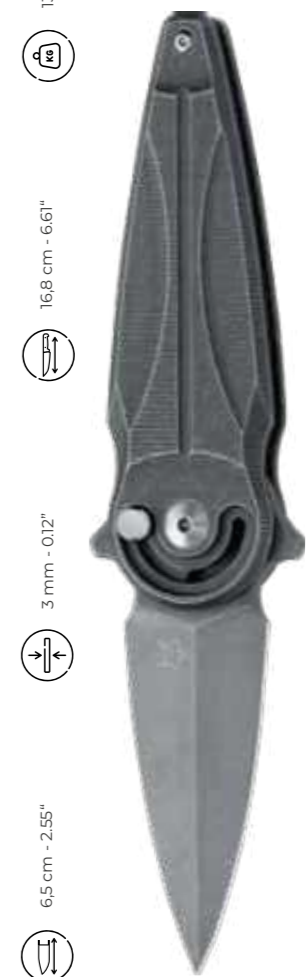

C67 + rame brunito  
Burnished C67 + copper  
HRC 54-56

Titanio PVD nero  
Black PVD titanium

Titanio anodizzato rosa  
Pink anodized titanium

Titanio anodizzato rosa  
Pink anodized titanium

Sagomata in titanio PVD nero  
Black PVD shaped titanium

Titanio anodizzato rosa  
Pink anodized titanium

M390 PVD nero  
Black PVD M390  
HRC 59-61

Titanio PVD nero  
Black PVD titanium

Titanio PVD nero  
Black PVD titanium

Titanio PVD nero  
Black PVD titanium

Sagomata in titanio PVD nero  
Black PVD shaped titanium

Titanio PVD nero  
Black PVD titanium

M390 satinato  
Satin M390  
HRC 59-61

Titanio PVD nero +  
scanalature lucide  
Black PVD titanium +  
polished grooves

Titanio lucido  
Polished titanium

Titanio lucido  
Polished titanium

Sagomata in titanio PVD nero  
Black PVD shaped titanium

Titanio lucido  
Polished titanium

Black idrogliker stone washed  
N690Co  
HRC 58-60

Alluminio anodizzato nero  
stone washed  
Stone washed black anodized  
aluminium

AISI 303 black idrogliker  
Black idrogliker AISI 420

AISI 303 black idrogliker  
Black idrogliker AISI 420

Sagomata in alluminio  
anodizzato nero  
Black anodized shaped  
aluminium

AISI 303 black idrogliker  
Black idrogliker AISI 303

Coarse stone washed N690Co  
HRC 58-60

Alluminio anodizzato grigio  
stone washed  
Stone washed grey anodized  
aluminium

AISI 303 lucido  
Polished AISI 420

AISI 303 lucido  
Polished AISI 420

Sagomata in alluminio  
anodizzato rosso  
Red anodized shaped  
aluminium

AISI 303 lucido  
Polished AISI 303

# FX-550 RADIUS

designed by Anarcnide



## FX-550 DGCFR RADIUS LOCK

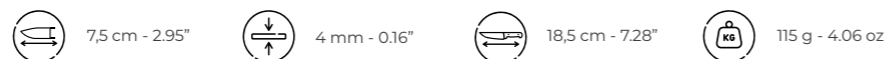

**LAMA | BLADE**  
Grabak™ by Damasteel®  
HRC 58-60

**DISTANZIALE | SPACER**  
Titanio PVD nero  
Black PVD titanium

**MANICO | HANDLE**  
Space Coral by Fatcarbon®

**CLIP**  
Sagomata in AISI 420 PVD nero  
Black PVD shaped AISI 420

**RADIUS LOCK**  
Titanio anodizzato rosa  
Pink anodized titanium  
▼  
Movimento con cuscinetti a sfera  
Ball bearing operating system

**VITI | SCREWS**  
Titanio anodizzato rosa  
Pink anodized titanium



Scatola + fodero in cuoio  
Box + leather sheath



Il coltello Radius di Fox Knives ha scosso il mondo degli utensili da taglio con la sua innovazione rivoluzionaria. Presentato al Blade Show di Atlanta nel 2019, questo coltello ha rapidamente conquistato l'attenzione e il rispetto della comunità degli appassionati e degli esperti di coltelli. Ciò che rende il Radius veramente straordinario è il suo sistema di chiusura unico e brevettato. Grazie a questo meccanismo innovativo, è possibile aprire e chiudere la lama con una sola mano, rendendo il coltello incredibilmente pratico e conveniente per una vasta gamma di applicazioni.

Oltre alla sua funzionalità superiore, il Radius di Fox Knives si distingue anche per il suo design elegante e ergonomico. Le linee pulite e la costruzione robusta lo rendono non solo un'aggiunta preziosa alla collezione di coltelli di ogni appassionato, ma anche uno strumento affidabile per le sfide quotidiane.

Fox Knives' Radius knife has shaken up the cutting tool world with its revolutionary innovation. Introduced at the Blade Show in Atlanta in 2019, this knife quickly gained the attention and respect of the knife enthusiast and expert community. What makes the Radius truly extraordinary is its unique and patented locking system.

Thanks to this innovative mechanism, the blade can be opened and closed with one hand, making the knife incredibly practical and convenient for a wide range of applications.

In addition to its superior functionality, the Radius from Fox Knives also stands out for its sleek, ergonomic design. The clean lines and sturdy construction make it not only a valuable addition to any enthusiast's knife collection, but also a reliable tool for everyday challenges.

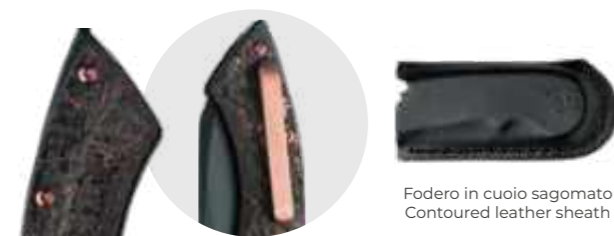

## FX-550 CFB RADIUS LOCK

▼  
Movimento con cuscinetti a sfera  
Ball bearing operating system

**LAMA | BALDE**  
M390 PVD nero  
Black PVD M390  
HRC 59-61

**DISTANZIALE | SPACER**  
Titanio PVD nero  
Black PVD titanium

**MANICO | HANDLE**  
Snake Skin Copper by  
Fatcarbon®

**CLIP**  
Sagomata in titanio  
anodizzato rosa  
Pink anodized shaped  
titanium

**RADIUS LOCK**  
Titanio anodizzato rosa  
Pink anodized titanium

**VITI | SCREWS**  
Titanio anodizzato rosa  
Pink anodized titanium

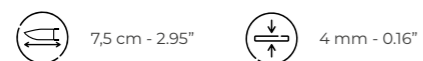

Fodero in cuoio sagomato  
Contoured leather sheath

Nylon® + patch Radius  
Nylon® + Radius patch



## FX-550 TiB RADIUS LOCK

▼  
Movimento con cuscinetti a sfera  
Ball bearing operating system

**LAMA | BLADE**  
M390 PVD nero  
Black PVD M390  
HRC 59-61

**DISTANZIALE | SPACER**  
Titanio PVD nero  
Black PVD titanium

**MANICO | HANDLE**  
Titanio PVD nero +  
scanalature lucide  
Black PVD titanium +  
polished grooves

**CLIP**  
Sagomata in titanio  
PVD nero  
Black PVD shaped  
titanium

**RADIUS LOCK**  
Titanio anodizzato bronzo  
Bronze anodized titanium

**VITI | SCREWS**  
Titanio anodizzato bronzo  
Bronze anodized titanium



Fodero in cuoio sagomato  
Contoured leather sheath

Nylon® + patch Radius  
Nylon® + Radius patch



## FX-550 G10B RADIUS LOCK

▼  
Movimento con cuscinetti a sfera  
Ball bearing operating system

**LAMA | BLADE**  
N690Co stone washed  
Stone washed N690Co  
HRC 58-60

**DISTANZIALE | SPACER**  
G10 nero  
Black G10

**MANICO | HANDLE**  
G10 nero  
Black G10

**CLIP**  
A filo in AISI 420 lucido  
Polished wire clip AISI 420

**RADIUS LOCK**  
AISI 303 lucido  
Polished AISI 303

**VITI | SCREWS**  
AISI 303 lucido  
Polished AISI 303



## FX-550 Ti RADIUS LOCK

▼  
Movimento con cuscinetti a sfera  
Ball bearing operating system

**LAMA | BLADE**  
M390 satinato  
Satin M390  
HRC 59-61

**DISTANZIALE | SPACER**  
Titanio anodizzato bronzo  
Bronze anodized titanium

**MANICO | HANDLE**  
Titanio sabbato  
Sandblasted titanium

**CLIP**  
Sagomata titanio  
anodizzato bronzo  
Bronze anodized shaped  
titanium

**RADIUS LOCK**  
Titanio anodizzato bronzo  
Bronze anodized titanium

**VITI | SCREWS**  
Titanio anodizzato bronzo  
Bronze anodized titanium

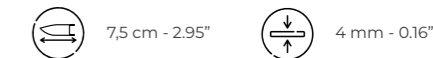

Fodero in cuoio sagomato  
Contoured leather sheath

Nylon® + patch Radius  
Nylon® + Radius patch



## FX-550 G10OD RADIUS LOCK

▼  
Movimento con cuscinetti a sfera  
Ball bearing operating system

**LAMA | BLADE**  
N690Co stone washed  
Stone washed N690Co  
HRC 58-60

**DISTANZIALE | SPACER**  
G10 arancione  
Orange G10

**MANICO | HANDLE**  
G10 verde OD  
OD green G10

**CLIP**  
A filo in AISI 420 lucido  
Polished wire clip AISI 420

**RADIUS LOCK**  
AISI 303 lucido  
Polished AISI 303

**VITI | SCREWS**  
AISI 303 lucido  
Polished AISI 303

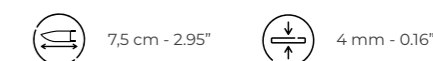

# FX-552 CHRONOS

designed by Stefan Merk

Ispirato a Crono, il capo dei Titani nella mitologia greca, questo coltello incarna forza, autorità e prestazioni impeccabili, qualità che si manifestano in ogni dettaglio. La lama, con il suo dorso alto e la forma sheepfoot, unisce robustezza ed eleganza, rendendola ideale per le attività quotidiane. Garantisce stabilità e prestazioni eccezionali anche in condizioni estreme, mantenendo un profilo non eccessivamente aggressivo. La sua costruzione sofisticata assicura che il coltello sia preparato per ogni sfida senza compromettere la funzionalità. Grazie all'impugnatura antiscivolo, offre una presa sicura e un controllo preciso, anche in condizioni di utilizzo difficili o con l'uso di guanti. Il Chronos è stato progettato per gli avventurieri che non fanno compromessi né sullo stile né sulla funzionalità. La sua eleganza e resistenza lo rendono un compagno affidabile, perfetto anche per i compiti più impegnativi.

Inspired by Kronos, the leader of the Titans in Greek mythology, this knife embodies strength, authority, and flawless performance, qualities that are evident in every detail. The blade, with its high back and sheepfoot shape, combines strength and elegance, making it ideal for everyday activities. It provides exceptional stability and performance even in extreme conditions while maintaining a profile that is not overly aggressive. Its sophisticated construction ensures that the knife is prepared for any challenge without compromising functionality. Thanks to the non-slip handle, it offers a secure grip and precise control, even under difficult conditions or when wearing gloves. The Chronos is designed for adventurers who make no compromises on either style or functionality. Its elegance and durability make it a reliable companion, perfect for even the most demanding tasks. Kronos: the Titan among knives.



Nylon®

## FX-552 ALCF

FRAME LOCK

Movimento con cuscinetti a sfera  
Ball bearing operating system

### LAMA | BLADE

Magnacut PVD nero  
Black PVD Magnacut  
HRC 62-64

### DISTANZIALE | SPACER

Titanio anodizzato bronzo  
Bronze anodized titanium

### MANICO | HANDLE

Dark Matter by  
Fatcarbon®

### CLIP

Sagomata titanio  
anodizzato bronzo  
Bronze anodized shaped  
titanium

### FRAME LOCK

Alluminio PVD nero  
Black PVD aluminium

### VITI | SCREWS

Titanio anodizzato bronzo  
Bronze anodized titanium



Nylon®

## FX-552 AL

FRAME LOCK

Movimento con cuscinetti a sfera  
Ball bearing operating system

### LAMA | BLADE

Magnacut PVD nero  
Black PVD Magnacut  
HRC 62-64

### DISTANZIALE | SPACER

Fibra di carbonio 3K  
3K carbon fiber

### MANICO | HANDLE

Alluminio anodizzato blu  
Blue anodized aluminium

### CLIP

Sagomata titanio  
anodizzato blu  
Blue anodized shaped  
titanium

### FRAME LOCK

Alluminio PVD nero  
Black PVD aluminium

### VITI | SCREWS

Titanio anodizzato blu  
Blue anodized titanium



Nylon®

## FX-552 ALBOR

FRAME LOCK

Movimento con cuscinetti a sfera  
Ball bearing operating system

### LAMA | BLADE

Magnacut PVD nero  
Black PVD Magnacut  
HRC 62-64

### DISTANZIALE | SPACER

Titanio PVD nero  
Black PVD titanium

### MANICO | HANDLE

Alluminio anodizzato  
arancione  
Orange anodized  
aluminium

### CLIP

Sagomata in AISI 420  
PVD nero  
Black PVD shaped AISI 420

### FRAME LOCK

Alluminio anodizzato  
arancione  
Orange anodized  
aluminium

### VITI | SCREWS

Titanio PVD nero  
Black PVD titanium



Nylon®

## FX-552 ALBR

FRAME LOCK

Movimento con cuscinetti a sfera  
Ball bearing operating system

### LAMA | BLADE

Magnacut satinato  
Satin Magnacut  
HRC 62-64

### DISTANZIALE | SPACER

Titanio PVD nero  
Black PVD titanium

### MANICO | HANDLE

Alluminio anodizzato  
bronzo  
Bronze anodized  
aluminium

### CLIP

Sagomata in AISI 420  
PVD nero  
Black PVD shaped AISI 420

### FRAME LOCK

Alluminio anodizzato  
bronzo  
Bronze anodized  
aluminium

### VITI | SCREWS

Titanio lucido  
Polished titanium



# FX-ATC-OG02 PACIFICO

designed by Terzuola

Il coltello Pacifico rappresenta il culmine del trasferimento di Bob Terzuola e sua moglie Suz a San Diego. Ispirato dalle loro giornate trascorse immersi nelle acque del Pacifico, questo coltello porta con sé l'essenza dell'oceano. Ogni dettaglio è plasmato dalle loro esperienze incontrando nuove creature marine, dalle balene ai delfini, che hanno lasciato un'impronta indelebile. La forma tradizionale dello Stiletto italiano è stata reinterpretata con l'aggiunta di una coda, evocando la grazia e la forza degli abitanti del mare.

Tenere in mano il Pacifico è come afferrare un pezzo dell'Oceano Pacifico stesso. Costruito con la robustezza che caratterizza le altre creazioni di Bob Terzuola, questo coltello non è solo un oggetto di bellezza, ma anche uno strumento affidabile per il trasporto quotidiano.

The Pacific knife represents the culmination of Bob Terzuola and his wife Suz's move to San Diego. Inspired by their days spent immersed in the waters of the Pacific, this knife carries with it the essence of the ocean. Every detail is shaped by their experiences encountering new sea creatures, from whales to dolphins, that have left an indelible imprint. The traditional shape of the Italian Stiletto has been reinterpreted with the addition of a tail, evoking the grace and strength of the sea inhabitants.

Holding the Pacific is like grasping a piece of the Pacific Ocean itself. Built with the sturdiness that characterizes Bob Terzuola's other creations, this knife is not only an object of beauty, but also a reliable tool for everyday carry.



## FX-ATC-OG02 DCF LINER LOCK

NEW  
ITEM

110 g - 3.88 oz



23 cm - 9.03"



3.5 mm - 0.13"



Packaging per il modello  
FX-ATC-OG02-DCF  
Packaging for FX-ATC-OG02-DCF  
model

Nylon® + patch Terzuola  
Nylon® + Terzuola patch

9.5 cm - 3.74"



Thor™ by Damasteel®  
HRC 58-60



Black Camo by Fatcarbon®



AISI 420 PVD nero  
Black PVD AISI 420



Black Camo by Fatcarbon®



Sagomata in titanio PVD nero  
Black PVD shaped titanium



AISI 303 PVD nero  
Black PVD AISI 303



LIMITED EDITION - LIMITED



## FX-ATC-OG02 MCF LINER LOCK

NEW  
ITEM

110 g - 3.88 oz



23 cm - 9.03"



3.5 mm - 0.13"



Nylon® + patch Terzuola  
Nylon® + Terzuola patch

9.5 cm - 3.74"



Magnacut satinato  
Satin Magnacut  
HRC 62-64



Dark Matter by Fatcarbon®



AISI 420 black idroglied  
Black idroglied AISI 420



G10 nero  
Black G10



Sagomata in titanio stone washed  
Stone washed shaped titanium



AISI 303 PVD nero  
Black PVD AISI 303



## FX-ATC-OG02 MD LINER LOCK

NEW  
ITEM

120 g - 4.23 oz



23 cm - 9.03"



3.5 mm - 0.13"



Nylon® + patch Terzuola  
Nylon® + Terzuola patch

9.5 cm - 3.74"



Magnacut stone washed  
Stone washed Magnacut  
HRC 62-64



Micarta denim  
Denim Micarta



AISI 420 stone washed  
Stone washed AISI 420



G10 blu  
Blue G10



Sagomata in titanio stone washed  
Stone washed shaped titanium



AISI 303 PVD nero  
Black PVD AISI 303



# FX-ATC-OG01 ORIGINAL GANGSTER

designed by Terzuola



## FX-ATC-OG01 LINER LOCK



### LAMA | BALDE

Magnacut coarse stone washed  
Coarse stone washed Magnacut  
HRC 62-64

### MANICO | HANDLE

Titanio coarse stone washed  
Coarse stone washed titanium

### LINER LOCK

AISI 420 sabbaiato  
Sandblasted AISI 420

Movimento con cuscinetti a sfera  
Ball bearing operating system

### DISTANZIALE | SPACER

G10 nero  
Black G10

### CLIP

Sagomata in titanio coarse  
stone washed  
Coarse stone washed shaped  
titanium

### VITI | SCREWS

AISI 303 lucido  
Polished AISI 303



Nylon® + patch Terzuola  
Nylon® + Terzuola patch



Nylon® + patch Terzuola  
Nylon® + Terzuola patch

## FX-ATC-OG01 LMB

### LINER LOCK

Movimento con cuscinetti a sfera  
Ball bearing operating system

### LAMA | BLADE

Magnacut satinato  
Satin Magnacut  
HRC 62-64

### MANICO | HANDLE

Micarta nera sabbaiata  
Sandblasted black Micarta

### LINER LOCK

AISI 420 sabbaiato  
Sandblasted AISI 420

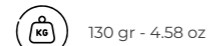

Nylon® + patch Terzuola  
Nylon® + Terzuola patch

## FX-ATC-OG01 MOD

### LINER LOCK

Movimento con cuscinetti a sfera  
Ball bearing operating system

### LAMA | BLADE

Magnacut stone washed  
Stone washed Magnacut  
HRC 62-64

### MANICO | HANDLE

Micarta verde OD sabbaiata  
Sandblasted OD green  
Micarta

### LINER LOCK

AISI 420 sabbaiato  
Sandblasted AISI 420

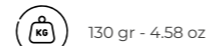

NEW  
ITEM

## FX-515

designed by Terzuola

### FX-515 W LINER LOCK



Fodero sagomato in cuoio  
Contoured leather sheath

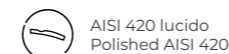
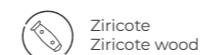
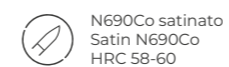

## FX-525 | THE SICILIAN

designed by Terzuola

### FX-525 MI LINER LOCK



Scopri l'intera linea The  
Sicilian ->  
Discover the entire line  
The Sicilian ->

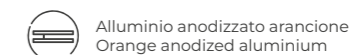
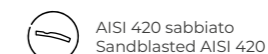
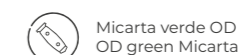
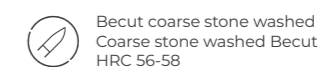

# FX-525 THE SICILIAN

designed by Terzuola



Fodero sagomato in cuoio per tutte le versioni con manico in legno  
Contoured leather sheath for all versions with wooden handle



Nylon®



Nylon®

## FX-525 DB LINER LOCK

100 g - 3.53 oz



20 cm - 7.67"



3 mm - 0.12"



8,5 cm - 3.35"



Dense Twist™ by Damasteel®  
HRC 58-60

Bocote  
Bocote wood

AISI 420 burattato  
Tumbled AISI 420

G10 nero  
Black G10

AISI 303 lucido  
Polished AISI 303

## FX-525 B LINER LOCK

100 g - 3.53 oz



20 cm - 7.67"



3 mm - 0.12"



8,5 cm - 3.35"



N690Co satinato  
Satin N690Co  
HRC 58-60

Bocote  
Bocote wood

AISI 420 burattato  
Tumbled AISI 420

G10 nero  
Black G10

AISI 303 lucido  
Polished AISI 303

## FX-525 OL LINER LOCK

100 g - 3.53 oz



20 cm - 7.67"



3 mm - 0.12"



8,5 cm - 3.35"



N690Co satinato  
Satin N690Co  
HRC 58-60

Ulivo  
Olive wood

AISI 420 burattato  
Tumbled AISI 420

G10 nero  
Black G10

AISI 303 lucido  
Polished AISI 303

## FX-525 BE LINER LOCK

100 g - 3.53 oz



20 cm - 7.67"



3 mm - 0.12"



8,5 cm - 3.35"



N690Co satinato  
Satin N690Co  
HRC 58-60

Betulla  
Birch wood

AISI 420 burattato  
Tumbled AISI 420

G10 nero  
Black G10

AISI 303 lucido  
Polished AISI 303

## FX-525 Ti BL LINER LOCK

100 g - 3.53 oz



20 cm - 7.67"



3 mm - 0.12"



8,5 cm - 3.35"



N690Co stone washed  
Stone washed N690Co  
HRC 58-60

Titanio anodizzato blu  
Blue anodized titanium

Titanio anodizzato blu  
Blue anodized titanium

AISI 420 lucido  
Polished AISI 420

Sagomata in titanio anodizzato blu  
Blue anodized shaped titanium

AISI 303 lucido  
Polished AISI 303

## FX-525 Ti LINER LOCK

100 g - 3.53 oz



20 cm - 7.67"



3 mm - 0.12"



8,5 cm - 3.35"



N690Co stone washed  
Stone washed N690Co  
HRC 58-60

Titanio sabbiato  
Sandblasted titanium

Titanio sabbiato  
Sandblasted titanium

AISI 420 lucido  
Polished AISI 420

Sagomata in titanio sabbiato  
Sandblasted shaped titanium

AISI 303 lucido  
Polished AISI 303

# FX-560 ANZU

designed by Les George

Les George ha progettato l'ANZU per avere la massima ergonomia dell'impugnatura, garantendo una presa salda, la lama drop point MAGNACUT massimizza la capacità di taglio e la resistenza alle macchie dell'acciaio. Il meccanismo di apertura VERSO Lock conferisce a questo coltello la massima efficienza. I doppi perni per il pollice e la chiusura VERSO rendono il coltello facile da aprire e chiudere con entrambe le mani. La clip consente un facile trasporto, rendendo il coltello sempre pronto all'uso

Les George designed the ANZU to have maximum handle ergonomics ensuring a positive grip, the drop point MAGNACUT blade maximizes cutting ability and stain resistance in the steel. The VERSO Lock opening mechanism gives this knife maximum efficiency. The dual thumb studs and VERSO lock make the knife easy to open and close with either hand. The clip allows easy carry making the knife always ready for use.



Photo by PANDA.PIRATES



## FX-560 CFOR VERSO LOCK

**LAMA | BLADE**  
Magnacut PVD nero  
Black PVD Magnacut  
HRC 62-64

**MANICO | HANDLE**  
Fibra di carbonio 3K  
3K carbon fiber

**VERSO LOCK**  
AISI 420 PVD nero  
Black PVD AISI 420

**DISTANZIALE | SPACER**  
Alluminio anodizzato  
arancione  
Orange anodized  
aluminium

**CLIP**  
Sagomata in AISI 420  
PVD nero  
Black PVD shaped AISI 420

**VITI | SCREWS**  
AISI 303 PVD nero  
Black PVD AISI 303

8 cm - 3.15"

3,5 mm - 0.13"

18 cm - 7.09"

105 gr - 3.70 oz



## FX-560 ALBR VERSO LOCK

**LAMA | BLADE**  
Magnacut PVD nero  
Black PVD Magnacut  
HRC 62-64

**MANICO | HANDLE**  
Alluminio anodizzato  
bronzo  
Bronze anodized  
aluminium

**VERSO LOCK**  
AISI 420 black idroglider  
Black idroglider AISI 420

**DISTANZIALE | SPACER**  
Alluminio anodizzato nero  
Black anodized aluminium

**CLIP**  
Sagomata in AISI 420  
black idroglider  
Black idroglider shaped  
AISI 420

**VITI | SCREWS**  
AISI 420 black idroglider  
Black idroglider AISI 420

8 cm - 3.15"

3,5 mm - 0.13"

18 cm - 7.09"

123 gr - 4.33 oz



## FX-560 ALOR VERSO LOCK

**LAMA | BLADE**  
Magnacut stone washed  
Stone washed Magnacut  
HRC 62-64

**MANICO | HANDLE**  
Alluminio anodizzato blu  
Blue anodized aluminium

**VERSO LOCK**  
AISI 420 lucido  
Polished AISI 420

**DISTANZIALE | SPACER**  
Alluminio anodizzato  
arancione  
Orange anodized  
aluminium

**CLIP**  
Sagomata in AISI 420  
stone washed  
Stone washed shaped  
AISI 420

**VITI | SCREWS**  
AISI 303 lucido  
Polished AISI 303

8 cm - 3.15"

3,5 mm - 0.13"

18 cm - 7.09"

120 gr - 4.23 oz



## FX-560 G10B VERSO LOCK

**LAMA | BLADE**  
Magnacut PVD nero  
stone washed  
Black PVD stone washed  
Magnacut  
HRC 62-64

**MANICO | HANDLE**  
G10 nero  
Black G10

**VERSO LOCK**  
AISI 420 black idroglider  
Black idroglider AISI 420

**DISTANZIALE | SPACER**  
Alluminio anodizzato verde  
Green anodized aluminium

**CLIP**  
Sagomata in AISI 420  
black idroglider  
Black idroglider shaped  
AISI 420

**VITI | SCREWS**  
AISI 420 black idroglider  
Black idroglider AISI 420

8 cm - 3.15"

3,5 mm - 0.13"

18 cm - 7.09"

113 gr - 3.99 oz



**ZERO 2.0**  
designed by Ansø

**FX-311 B**  
BACK LOCK

**LAMA | BLADE**  
Becut Top Shield® nero  
Black Top Shield® Becut  
HRC 56-58

**CLIP**  
AISI 420 Top Shield® nero  
Black Top Shield® AISI 420

**MANICO | HANDLE**  
FRN® nero  
Black FRN®

**VITI | SCREWS**  
Sagomata in AISI 303 Top  
Shield® nero  
Black Top Shield® shaped  
AISI 303

**BACK LOCK**  
AISI 420 Top Shield® nero  
Black Top Shield® AISI 420

|  |                 |  |                |
|--|-----------------|--|----------------|
|  | 7 cm - 2.75"    |  | 3 mm - 0.12"   |
|  | 16,5 cm - 6.49" |  | 56 g - 1.98 oz |



**ZERO 2.0**  
designed by Ansø

**FX-311 GY**  
BACK LOCK

**LAMA | BLADE**  
Becut coarse stone washed  
Coarse stone washed Becut  
HRC 56-58

**CLIP**  
AISI 420 sabbaiato  
Sandblasted AISI 420

**MANICO | HANDLE**  
FRN® grey  
Grey FRN®

**VITI | SCREWS**  
Sagomata in AISI 303  
sabbaiato  
Sandblasted shaped  
AISI 303

**BACK LOCK**  
AISI 420 coarse stone washed  
Coarse stone washed AISI 420

|  |                 |  |                |
|--|-----------------|--|----------------|
|  | 7 cm - 2.75"    |  | 3 mm - 0.12"   |
|  | 16,5 cm - 6.49" |  | 56 g - 1.98 oz |

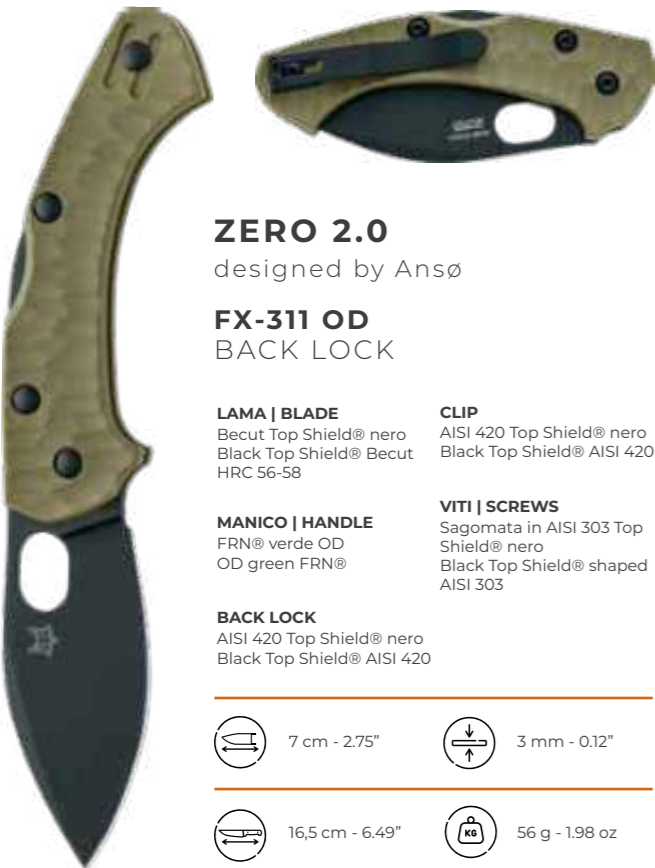

**ZERO 2.0**  
designed by Ansø

**FX-311 OD**  
BACK LOCK

**LAMA | BLADE**  
Becut Top Shield® nero  
Black Top Shield® Becut  
HRC 56-58

**CLIP**  
AISI 420 Top Shield® nero  
Black Top Shield® AISI 420

**MANICO | HANDLE**  
FRN® verde OD  
OD green FRN®

**VITI | SCREWS**  
Sagomata in AISI 303 Top  
Shield® nero  
Black Top Shield® shaped  
AISI 303

**BACK LOCK**  
AISI 420 Top Shield® nero  
Black Top Shield® AISI 420

|  |                 |  |                |
|--|-----------------|--|----------------|
|  | 7 cm - 2.75"    |  | 3 mm - 0.12"   |
|  | 16,5 cm - 6.49" |  | 56 g - 1.98 oz |



**ZERO 2.0**  
designed by Ansø

**FX-311 CT**  
BACK LOCK

**LAMA | BLADE**  
Becut Top Shield® coyote  
Coyote Top Shield® Becut  
HRC 56-58

**CLIP**  
AISI 420 Top Shield® coyote  
Coyote Top Shield® AISI 420

**MANICO | HANDLE**  
FRN® coyote  
Coyote FRN®

**VITI | SCREWS**  
Sagomata in AISI 303 Top  
Shield® coyote  
Coyote Top Shield® shaped  
AISI 303

**BACK LOCK**  
AISI 420 Top Shield® coyote  
Coyote Top Shield® AISI 420

|  |                 |  |                |
|--|-----------------|--|----------------|
|  | 7 cm - 2.75"    |  | 3 mm - 0.12"   |
|  | 16,5 cm - 6.49" |  | 56 g - 1.98 oz |



**ZIGGY**  
designed by Ansø

**FX-308 ZW**  
LINER LOCK

**LAMA | BLADE**  
N690Co satinato  
Satin N690Co  
HRC 58-60

**DISTANZIALE | SPACER**  
G10 nero  
Black G10

**MANICO | HANDLE**  
Ziricote  
Ziricote wood

**CLIP**  
Sagomata AISI 420  
burattato  
Tumbled shaped AISI 420

**LINER LOCK**  
AISI 420 burattato  
Tumbled AISI 420

**VITI | SCREWS**  
AISI 303 rivestito al nichel  
Nickel plated AISI 303

|  |               |  |                 |
|--|---------------|--|-----------------|
|  | 8 cm - 3.15"  |  | 3,5 mm - 0.14"  |
|  | 20 cm - 7.67" |  | 110 g - 3.88 oz |

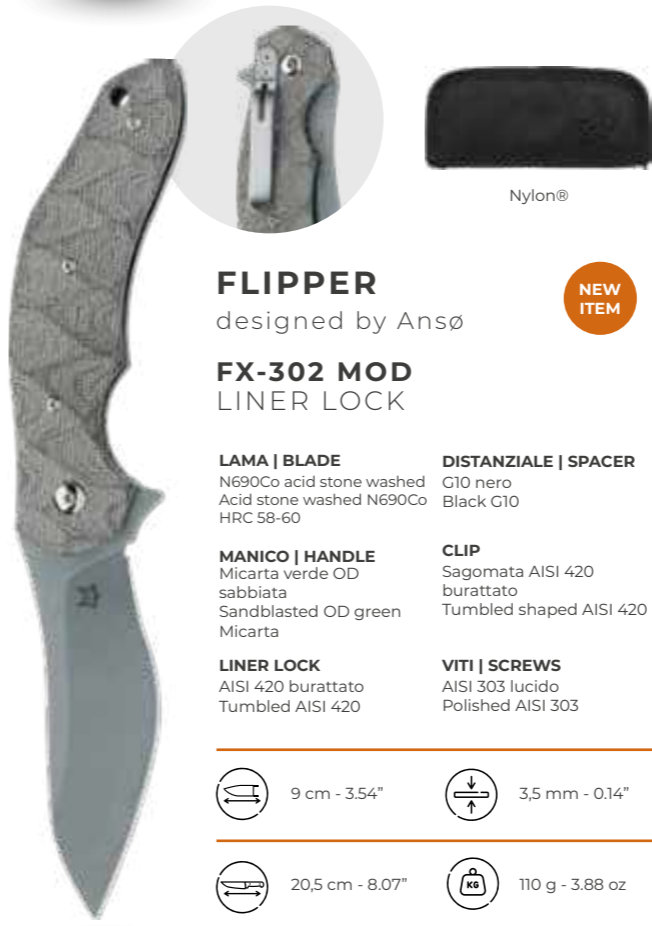

**FLIPPER**  
designed by Ansø

**FX-302 MOD**  
LINER LOCK

**LAMA | BLADE**  
N690Co acid stone washed  
Acid stone washed N690Co  
HRC 58-60

**DISTANZIALE | SPACER**  
G10 nero  
Black G10

**MANICO | HANDLE**  
Micarta verde OD  
sabbaiata  
Sandblasted OD green  
Micarta

**CLIP**  
Sagomata AISI 420  
burattato  
Tumbled shaped AISI 420

**LINER LOCK**  
AISI 420 burattato  
Tumbled AISI 420

**VITI | SCREWS**  
AISI 303 lucido  
Polished AISI 303

|  |                 |  |                 |
|--|-----------------|--|-----------------|
|  | 9 cm - 3.54"    |  | 3,5 mm - 0.14"  |
|  | 20,5 cm - 8.07" |  | 110 g - 3.88 oz |



**FLIPPER**  
designed by Ansø

**FX-302**  
FRAME LOCK

**LAMA | BLADE**  
N690Co satinato  
Satin N690Co  
HRC 58-60

**DISTANZIALE | SPACER**  
G10 nero  
Black G10

**MANICO | HANDLE**  
Titanio sabbaiato  
Sandblasted titanium

**CLIP**  
Sagomata in titanio  
sabbaiato  
Sandblasted shaped  
titanium

**FRAME LOCK**  
Titanio sabbaiato  
Sandblasted titanium

**VITI | SCREWS**  
AISI 303 lucido  
Polished AISI 303

|  |                 |  |                 |
|--|-----------------|--|-----------------|
|  | 9 cm - 3.54"    |  | 3,5 mm - 0.14"  |
|  | 20,5 cm - 8.07" |  | 185 g - 6.52 oz |



**FLIPPER**  
designed by Ansø

**FX-302 MIN**  
LINER LOCK

**LAMA | BLADE**  
N690Co acid stone washed  
Acid stone washed N690Co  
HRC 58-60

**DISTANZIALE | SPACER**  
G10 nero  
Black G10

**MANICO | HANDLE**  
Micarta naturale sabbaiata  
Sandblasted natural  
Micarta

**CLIP**  
Sagomata AISI 420  
burattato  
Tumbled shaped AISI 420

**LINER LOCK**  
AISI 420 burattato  
Tumbled AISI 420

**VITI | SCREWS**  
AISI 303 lucido  
Polished AISI 303

|  |                 |  |                 |
|--|-----------------|--|-----------------|
|  | 9 cm - 3.54"    |  | 3,5 mm - 0.14"  |
|  | 20,5 cm - 8.07" |  | 110 g - 3.88 oz |

NEW ITEM

NEW ITEM

# FX-526 SURU

designed by Vox

Il Suru è stato concepito come un coltello chiudibile compatto, progettato per offrire una presa completa del manico nonostante le sue dimensioni ridotte. La lama robusta da 4 mm e la sua affilatura piatta lo rendono uno strumento forte ed efficiente, ideale per affrontare una vasta gamma di compiti quotidiani che richiedono precisione e taglio netto. Grazie alla sua ergonomia studiata nei minimi dettagli, al trasporto comodo, all'azione fluida del flipper e alla lama estremamente affilata, il Suru diventerà rapidamente uno dei tuoi coltelli preferiti, sempre pronto a soddisfare le tue esigenze quotidiane con facilità e affidabilità.

The Suru was conceived as a compact folding knife designed to offer a full handle grip despite its small size. Its sturdy 4 mm blade and flat edge make it a strong and efficient tool, ideal for tackling a wide range of daily tasks that require precision and clean cutting. With its well thought-out ergonomics, comfortable carry, smooth flipper action and extremely sharp blade, the Suru will quickly become one of your favorite knives, always ready to meet your daily needs with ease and reliability.



Photo by EDC.CULT



Cuoio, feltro e Nylon®  
Leather, felt and Nylon®



Cuoio, feltro e Nylon®  
Leather, felt and Nylon®



Cuoio, feltro e Nylon®  
Leather, felt and Nylon®

## FX-526 TI BB FRAME LOCK

Movimento con cuscinetti a sfera  
Ball bearing operating system

95 gr - 3.35 oz



14,8 cm - 5.82"



4 mm - 0.16"



6 cm - 2.36"



M390 PVD nero  
Black PVD M390  
HRC 59-61



Titanio PVD nero  
Black PVD titanium



Titanio PVD nero  
Black PVD titanium



Titanio anodizzato bronzo  
Bronze anodized titanium



Sagomata in titanio anodizzato bronzo  
Bronze anodized shaped titanium



Titanio anodizzato bronzo  
Bronze anodized titanium

## FX-526 SX TIBR FRAME LOCK

Movimento con cuscinetti a sfera  
Ball bearing operating system

90 gr - 3.17 oz



LEFT-HANDED

14,8 cm - 5.82"



4 mm - 0.16"



6 cm - 2.36"



M390 PVD nero  
Black PVD M390  
HRC 59-61



Titanio PVD nero  
Black PVD titanium



Titanio PVD nero  
Black PVD titanium



Titanio anodizzato bronzo  
Bronze anodized titanium



Sagomata in titanio anodizzato bronzo  
Bronze anodized shaped titanium



Titanio anodizzato bronzo  
Bronze anodized titanium

## FX-526 SX TIBL FRAME LOCK

Movimento con cuscinetti a sfera  
Ball bearing operating system

95 gr - 3.35 oz



LEFT-HANDED

14,8 cm - 5.82"



4 mm - 0.16"



6 cm - 2.36"



M390 satinato  
Satin M390  
HRC 59-61



Titanio sabbato  
Sandblasted titanium



Titanio sabbato  
Sandblasted titanium



Titanio anodizzato blu  
Blue anodized titanium



Sagomata in titanio anodizzato blu  
Blue anodized shaped titanium



Titanio anodizzato blu  
Blue anodized titanium



Cuoio nero  
Black leather

### FX-526LI CF LINER LOCK

Movimento con cuscinetti a sfera  
Ball bearing operating system

84 g - 2.96 oz



14,8 cm - 5.82"



4 mm - 0.16"



6 cm - 2.36"



- M398 PVD nero stone washed  
Black PVD stone washed M398  
HRC 60-62
- Fibra di carbonio 3K  
3K carbon fiber
- AISI 420 black idrogliider  
Black idrogliider AISI 420
- Titanio PVD nero  
Black PVD titanium
- A filo in AISI 420 black idrogliider  
Black idrogliider wire clip AISI 420
- Titanio anodizzato bronzo  
Bronze anodized titanium



Cuoio nero  
Black leather

### FX-526 CF FRAME LOCK

Movimento con cuscinetti a sfera  
Ball bearing operating system

58 g - 2.04 oz



14,8 cm - 5.82"



4 mm - 0.16"



6 cm - 2.36"



- M390 satinato  
Satin M390  
HRC 59-61
- Fibra di carbonio  
Carbon fiber
- Fibra di carbonio  
Carbon fiber
- Fibra di carbonio  
Carbon fiber
- Sagomata in titanio anodizzato bronzo  
Bronze anodized shaped titanium
- Titanio anodizzato bronzo  
Bronze anodized titanium



Cuoio nero  
Black leather

### FX-526 CFBL FRAME LOCK

Movimento con cuscinetti a sfera  
Ball bearing operating system

58 g - 2.04 oz



14,8 cm - 5.82"



4 mm - 0.16"



6 cm - 2.36"



- M390 satinata  
Satin M390  
HRC 59-61
- Fibra di carbonio  
Carbon fiber
- Fibra di carbonio  
Carbon fiber
- Fibra di carbonio  
Carbon fiber
- Sagomata in titanio anodizzato blu  
Blue anodized shaped titanium
- Titanio anodizzato blu  
Blue anodized titanium



Cuoio borgogna  
Burgundy leather

### FX-526LI MBU LINER LOCK

Movimento con cuscinetti a sfera  
Ball bearing operating system

**LAMA | BLADE**  
M398 PVD nero stone washed  
Black PVD stone washed M398  
HRC 60-62

**MANICO | HANDLE**  
Micarta borgogna sabbata  
Sandblasted burgundy Micarta

**LINER LOCK**  
AISI 420 black idrogliider  
Black idrogliider AISI 420

**DISTANZIALE | SPACER**  
Titanio PVD nero stone washed  
Black PVD stone washed titanium

**CLIP**  
A filo AISI 420 black idrogliider  
Black idrogliider wire clip AISI 420

**VITI | SCREWS**  
AISI 303 PVD nero  
Black PVD AISI 303



6 cm - 2.36"

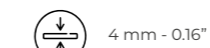

4 mm - 0.16"



14,8 cm - 5.82"



85 g - 2.99 oz



Cuoio verde  
Green leather

### FX-526LI MOD LINER LOCK

Movimento con cuscinetti a sfera  
Ball bearing operating system

**LAMA | BLADE**  
M398 stone washed  
Stone washed M398  
HRC 60-62

**MANICO | HANDLE**  
Micarta verde OD sabbata  
Sandblasted OD green Micarta

**LINER LOCK**  
AISI 420 burattato  
Tumbled AISI 420

**DISTANZIALE | SPACER**  
Ottone stone washed  
Stone washed brass

**CLIP**  
A filo in AISI 420 lucido  
Polished wire clip AISI 420

**VITI | SCREWS**  
AISI 303 lucido  
Polished AISI 303



6 cm - 2.36"

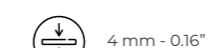

4 mm - 0.16"

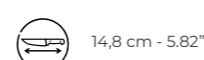

14,8 cm - 5.82"



85 g - 2.99 oz



Cuoio nero  
Black leather

### FX-526LI MB LINER LOCK

Movimento con cuscinetti a sfera  
Ball bearing operating system

**LAMA | BLADE**  
M398 coarse stone washed  
Coarse stone washed M398  
HRC 60-62

**MANICO | HANDLE**  
Micarta nera sabbata  
Sandblasted black Micarta

**LINER LOCK**  
AISI 420 sabbata  
Sandblasted AISI 420

**DISTANZIALE | SPACER**  
Titanio Coarse stone washed  
Coarse stone washed titanium

**CLIP**  
A filo in AISI 420 sabbata  
Sandblasted wire clip AISI 420

**VITI | SCREWS**  
AISI 303 sabbata  
Sandblasted AISI 303



6 cm - 2.36"

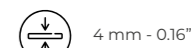

4 mm - 0.16"



14,8 cm - 5.82"



85 g - 2.99 oz



### FX-526LI MNA LINER LOCK

Movimento con cuscinetti a sfera  
Ball bearing operating system

**LAMA | BLADE**  
M398 satinato  
Satin M398  
HRC 60-62

**MANICO | HANDLE**  
Micarta naturale sabbata  
Sandblasted natural Micarta

**LINER LOCK**  
AISI 420 burattato  
Tumbled AISI 420

**DISTANZIALE | SPACER**  
Titanio stone washed  
Stone washed titanium

**CLIP**  
A filo in AISI 420 lucido  
Polished wire clip AISI 420

**VITI | SCREWS**  
AISI 303 lucido  
Polished AISI 303



6 cm - 2.36"



4 mm - 0.16"



14,8 cm - 5.82"



85 g - 2.99 oz



### FX-526 ALB FRAME LOCK

Movimento con cuscinetti a sfera  
Ball bearing operating system

85 g - 2.99 oz



14,8 cm - 5.82"



4 mm - 0.16"



6 cm - 2.36"



N690Co black idroglider stone washed  
Black idroglider stone washed N690Co  
HRC 58-60

Alluminio anodizzato nero stone washed  
Black stone washed anodized aluminium

Alluminio anodizzato nero stone washed  
Black stone washed anodized aluminium

Alluminio black idroglider stone washed  
Black idroglider stone washed aluminium

A filo in AISI 420 black idroglider  
Black idroglider wire clip AISI 420

AISI 303 black idroglider  
Black idroglider AISI 303



### FX-526 ALG FRAME LOCK

Movimento con cuscinetti a sfera  
Ball bearing operating system

85 g - 2.99 oz



14,8 cm - 5.82"



4 mm - 0.16"



6 cm - 2.36"



N690Co black idroglider stone washed  
Black idroglider stone washed N690Co  
HRC 58-60

Alluminio anodizzato verde stone washed  
Green stone washed anodized aluminium

Alluminio anodizzato verde stone washed  
Green stone washed anodized aluminium

Alluminio black idroglider stone washed  
Black idroglider stone washed aluminium

A filo in AISI 420 black idroglider  
Black idroglider wire clip AISI 420

AISI 303 black idroglider  
Black idroglider AISI 303



### FX-526 ALO FRAME LOCK

Movimento con cuscinetti a sfera  
Ball bearing operating system

85 g - 2.99 oz



14,8 cm - 5.82"



4 mm - 0.16"



6 cm - 2.36"



N690Co black idroglider stone washed  
Black idroglider stone washed N690Co  
HRC 58-60

Alluminio anodizzato arancione stone washed  
Orange stone washed anodized aluminium

Alluminio anodizzato arancione stone washed  
Orange stone washed anodized aluminium

Alluminio black idroglider stone washed  
Black idroglider stone washed aluminium

A filo in AISI 420 black idroglider  
Black idroglider wire clip AISI 420

AISI 303 black idroglider  
Black idroglider AISI 303

## FX-527 YARU

designed by Vox



### FX-527 CF FRAME LOCK

7 cm - 2.75"

4 mm - 0.16"

17,5 cm - 6.88"

95 g - 3.35 oz

#### LAMA | BLADE

CPM S90V PVD nero stone washed  
Black PVD stone washed CPM S90V  
HRC 59-61

#### MANICO | HANDLE

Snake Skin Copper by Fatcarbon®

#### FRAMELOCK

Titanio PVD nero stone washed  
Black PVD stone washed titanium  
Movimento con cuscinetti a sfera  
Ball bearing operating system

#### DISTANZIALE | SPACER

Titanio PVD nero stone washed  
Black PVD stone washed titanium

#### CLIP

Titanio PVD nero stone washed  
Black PVD stone washed titanium



Cuoio nero  
Black leather



#### VITI | SCREWS

Titanio PVD nero  
Black PVD titanium



### FX-527LI CF LINER LOCK

7 cm - 2.75"

4 mm - 0.16"

17,5 cm - 6.88"

97,5 g - 3.45 oz

#### LAMA | BLADE

M398 PVD nero stone washed  
Black PVD stone washed M398  
HRC 60-62

#### MANICO | HANDLE

Fibra di carbonio 3K  
3K carbon fiber

#### LINER LOCK

AISI 420 black idroglider  
Black idroglider AISI 420

Movimento con cuscinetti a sfera  
Ball bearing operating system

#### DISTANZIALE | SPACER

Titanio PVD nero  
Black PVD titanium

#### CLIP

A filo in AISI 420 black idroglider  
Black idroglider wire clip AISI 420



Cuoio nero  
Black leather





## FX-527 TI

### FRAME LOCK



#### LAMA | BLADE

CPM S90V acid stone washed  
Acid stone washed CPM S90V  
HRC 59-61

#### MANICO | HANDLE

Titanio anodizzato blu sabbato stone washed  
Sandblasted stone washed blue anodized titanium

#### FRAME LOCK

Titanio anodizzato blu stone washed  
Stone washed blue anodized titanium

Movimento con cuscinetti a sfera  
Ball bearing operating system

#### DISTANZIALE | SPACER

Titanio coarse stone washed  
Coarse stone washed titanium

#### CLIP

Sagomata in titanio anodizzato blu  
Blue anodized shaped titanium

#### VITI | SCREWS

Titanio anodizzato blu  
Blue anodized titanium



Cuoio nero  
Black leather



## FX-527 TIPVD

### FRAME LOCK

Movimento con cuscinetti a sfera  
Ball bearing operating system

#### LAMA | BLADE

CPM S90V PVD nero stone washed  
Black PVD stone washed  
CPM S90V  
HRC 59-61

#### MANICO | HANDLE

Titanio PVD nero stone washed  
Black PVD stone washed titanium

#### FRAME LOCK

Titanio PVD nero stone washed  
Black PVD stone washed titanium

#### DISTANZIALE | SPACER

Titanio PVD nero stone washed  
Black PVD stone washed titanium

#### CLIP

Sagomata in titanio anodizzato bronzo  
Bronze anodized shaped titanium

#### VITI | SCREWS

Titanio anodizzato bronzo  
Bronze anodized titanium



## FX-527LI MBU

### LINER LOCK

Movimento con cuscinetti a sfera  
Ball bearing operating system

#### LAMA | BLADE

M398 PVD nero stone washed  
Black PVD stone washed  
M398  
HRC 60-62

#### MANICO | HANDLE

Micarta borgogna sabbata  
Sandblasted burgundy Micarta

#### LINER LOCK

AISI 420 black idroglider  
Black idroglider AISI 420

#### DISTANZIALE | SPACER

Titanio PVD nero stone washed  
Black PVD stone washed titanium

#### CLIP

A filo AISI 420 black idroglider  
Black idroglider wire clip  
AISI 420

#### VITI | SCREWS

AISI 303 PVD nero  
Black PVD AISI 303



## FX-527LI MOD

### LINER LOCK

Movimento con cuscinetti a sfera  
Ball bearing operating system

#### LAMA | BLADE

M398 stone washed  
Stone washed M398  
HRC 60-62

#### MANICO | HANDLE

Micarta verde OD sabbata  
Sandblasted OD green  
Micarta

#### LINER LOCK

AISI 420 burattato  
Tumbled AISI 420

#### DISTANZIALE | SPACER

Ottone stone washed  
Stone washed brass

#### CLIP

A filo in AISI 420 lucido  
Polished wire clip AISI 420

#### VITI | SCREWS

AISI 303 lucido  
Polished AISI 303



## FX-527LI MB

### LINER LOCK

Movimento con cuscinetti a sfera  
Ball bearing operating system

#### LAMA | BLADE

M398 coarse stone washed  
Coarse stone washed M398  
HRC 60-62

#### MANICO | HANDLE

Micarta nera sabbata  
Sandblasted black Micarta

#### LINER LOCK

AISI 420 sabbato  
Sandblasted AISI 420

#### DISTANZIALE | SPACER

Titanio coarse stone washed  
Coarse stone washed titanium

#### CLIP

A filo in AISI 420 sabbato  
Sandblasted wire clip AISI 420

#### VITI | SCREWS

AISI 303 sabbato  
Sandblasted AISI 303



## FX-527LI MNA

### LINER LOCK

Movimento con cuscinetti a sfera  
Ball bearing operating system

#### LAMA | BLADE

M398 satinato  
Satin M398  
HRC 60-62

#### MANICO | HANDLE

Micarta naturale sabbata  
Sandblasted natural  
Micarta

#### LINER LOCK

AISI 420 burattato  
Tumbled AISI 420

#### DISTANZIALE | SPACER

Titanio coarse stone washed  
Coarse stone washed titanium

#### CLIP

A filo in AISI 420 lucido  
Polished wire clip AISI 420

#### VITI | SCREWS

AISI 303 lucido  
Polished AISI 303

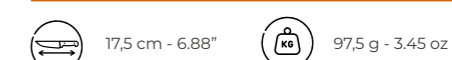

# FX-608 BABY CORE

designed by Vox



Fodero in cuoio nero per la versione in titanio e fibra di carbonio  
Black eather sheath for titanium and carbon fiber versions



## FX-608 TI LINER LOCK

Movimento con cuscinetti a sfera  
Ball bearing operating system

110 g - 3.88 oz



14,5 cm - 5.7"



3 mm - 0.12"



6 cm - 2.36"



## FX-608 CF LINER LOCK

Movimento con cuscinetti a sfera  
Ball bearing operating system

80 g - 2.82 oz



14,5 cm - 5.7"



3 mm - 0.12"



6 cm - 2.36"



## FX-608 B LINER LOCK

Movimento con cuscinetti a sfera  
Ball bearing operating system

80 g - 2.82 oz



14,5 cm - 5.7"



3 mm - 0.12"



6 cm - 2.36"



## FX-608 OR LINER LOCK

Movimento con cuscinetti a sfera  
Ball bearing operating system

80 g - 2.82 oz



14,5 cm - 5.7"



3 mm - 0.12"



6 cm - 2.36"



## FX-608 BL LINER LOCK

Movimento con cuscinetti a sfera  
Ball bearing operating system

80 g - 2.82 oz



14,5 cm - 5.7"



3 mm - 0.12"



6 cm - 2.36"



## FX-608 R LINER LOCK

Movimento con cuscinetti a sfera  
Ball bearing operating system

80 g - 2.82 oz



14,5 cm - 5.7"



3 mm - 0.12"



6 cm - 2.36"



- M390 coarse stone washed  
Coarse stone washed M390  
HRC 59-61
- Titanio coarse stone washed  
Coarse stone washed titanium
- AISI 420 burattato  
Tumbled AISI 420
- Titanio anodizzato bronzo  
Bronze anodized titanium
- A filo in AISI 420 sabbato  
Sandblasted wire clip AISI 420
- AISI 303 sabbato  
Sandblasted AISI 303

- M390 satinato  
Satin M390  
HRC 59-61
- Fibra di carbonio  
Carbon fiber
- AISI 420 burattato  
Tumbled AISI 420
- Fibra di carbonio  
Carbon fiber
- A filo AISI 420 lucido  
Polished wire clip AISI 420
- AISI 303 lucido  
Polished AISI 303

- N690Co black idrogliker stone washed  
Black idrogliker stone washed N690Co  
HRC 58-60
- FRN® nero  
Black FRN®
- AISI 420 black idrogliker  
Black idrogliker AISI 420
- Alluminio anodizzato blu  
Blue anodized aluminium
- A filo in AISI 420 black idrogliker  
Black idrogliker wir clip AISI 420
- AISI 303 black idrogliker  
Black idrogliker AISI 303

- N690Co black idrogliker stone washed  
Black idrogliker stone washed N690Co  
HRC 58-60
- FRN® arancione  
Orange FRN®
- AISI 420 black idrogliker  
Black idrogliker AISI 420
- Alluminio anodizzato nero  
Black anodized aluminium
- A filo in AISI 420 black idrogliker  
Black idrogliker wir clip AISI 420
- AISI 303 black idrogliker  
Black idrogliker AISI 303

- N690Co stone washed  
Stone washed N690Co  
HRC 58-60
- FRN® blu  
Blue FRN®
- AISI 420 burattato  
Tumbled AISI 420
- Alluminio anodizzato arancione  
Orange anodized aluminium
- A filo AISI 420 lucido  
Polished wire clip AISI 420
- AISI 303 lucido  
Polished AISI 303

- N690Co stone washed  
Stone washed N690Co  
HRC 58-60
- FRN® rosso  
Red FRN®
- AISI 420 burattato  
Tumbled AISI 420
- Alluminio anodizzato grigio  
Grey anodized aluminium
- A filo AISI 420 lucido  
Polished wire clip AISI 420
- AISI 303 lucido  
Polished AISI 303

# FX-604 CORE

designed by Vox



## FX-604 CF LINER LOCK



**LAMA | BLADE**  
Elmax PVD nero  
Black PVD Elmax  
HRC 59-61

**DISTANZIALE | SPACER**  
Titanio anodizzato grigio  
Grey anodized titanium

**MANICO | HANDLE**  
Fibra di carbonio 3K  
3K carbon fiber

**CLIP**  
A filo in AISI 420 PVD nero  
Black PVD wire clip AISI 420

**LINER LOCK**  
AISI 420 black idrogliider  
Black idrogliider AISI 420

▼  
Movimento con cuscinetti a sfera  
Ball bearing operating system

**VITI | SCREWS**  
AISI 303 PVD nero  
Black PVD AISI 303



Nylon®



## FX-604 ALBR LINER LOCK

▼  
Movimento con cuscinetti a sfera  
Ball bearing operating system

**LAMA | BLADE**  
Elmax Top Shield® nero  
Top Shield® nero Elmax  
HRC 59-61

**DISTANZIALE | SPACER**  
Alluminio anodizzato nero  
Black anodized aluminium

**MANICO | HANDLE**  
Alluminio anodizzato  
marrone stone washed  
Stone washed brown  
anodized aluminium

**CLIP**  
A filo in AISI 420 black  
idrogliider  
Black idrogliider wire clip  
AISI 420

**LINER LOCK**  
AISI 420 black idrogliider  
Black idrogliider AISI 420

**VITI | SCREWS**  
AISI 303 black idrogliider  
Black idrogliider AISI 303



## FX-604 ALSW LINER LOCK

▼  
Movimento con cuscinetti a sfera  
Ball bearing operating system

**LAMA | BLADE**  
Elmax stone washed  
Stone washed Elmax  
HRC 59-61

**DISTANZIALE | SPACER**  
Alluminio stone washed  
Stone washed aluminium

**MANICO | HANDLE**  
Alluminio stone washed  
Stone washed aluminium

**CLIP**  
A filo in AISI 420 lucido  
Polished wire clip AISI 420

**LINER LOCK**  
AISI 420 burattato  
Tumbled AISI 420

**VITI | SCREWS**  
AISI 303 lucido  
Polished AISI 303



Nylon®

## FX-604 MBR LINER LOCK

▼  
Movimento con cuscinetti a sfera  
Ball bearing operating system

**LAMA | BLADE**  
Elmax coarse stone  
washed  
Coarse stone washed  
Elmax  
HRC 59-61

**DISTANZIALE | SPACER**  
Ottone stone washed  
Stone washed brass

**MANICO | HANDLE**  
Micarta marrone  
Brown Micarta

**CLIP**  
A filo in AISI 420 sabbato  
Sandblasted wire clip  
AISI 420

**LINER LOCK**  
AISI 420 sabbato  
Sandblasted AISI 420

**VITI | SCREWS**  
AISI 303 sabbato  
Sandblasted AISI 303



Nylon®

## FX-604 MFG LINER LOCK

▼  
Movimento con cuscinetti a sfera  
Ball bearing operating system

**LAMA | BLADE**  
Elmax stone washed  
Stone washed Elmax  
HRC 59-61

**DISTANZIALE | SPACER**  
Alluminio anodizzato  
arancione  
Orange anodized  
aluminium

**MANICO | HANDLE**  
Micarta verde  
Green Micarta

**CLIP**  
A filo in AISI 420 sabbato  
Sandblasted wire clip  
AISI 420

**LINER LOCK**  
AISI 420 burattato  
Tumbled AISI 420

**VITI | SCREWS**  
AISI 303 sabbato  
Sandblasted AISI 303



Nylon®

## FX-604 MN LINER LOCK

▼  
Movimento con cuscinetti a sfera  
Ball bearing operating system

**LAMA | BLADE**  
Elmax satinato  
Satin Elmax  
HRC 59-61

**DISTANZIALE | SPACER**  
Ottone stone washed  
Stone washed brass

**MANICO | HANDLE**  
Micarta naturale  
Natural Micarta

**CLIP**  
A filo in AISI 420 lucido  
Polished wire clip AISI 420

**LINER LOCK**  
AISI 420 burattato  
Tumbled AISI 420

**VITI | SCREWS**  
AISI 303 lucido  
Polished AISI 303

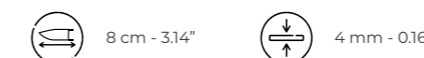



### FX-604 B LINER LOCK

Movimento con cuscinetti a sfera  
Ball bearing operating system

135 g - 4,76 oz



19 cm - 7,48"



4 mm - 0,16"



8 cm - 3,14"



N690Co Top Shield® nero  
Black Top Shield® N690Co  
HRC 58-60



FRN® nero  
Black FRN®



AISI 420 black idrogliider  
Black idrogliider AISI 420



Alluminio anodizzato arancione  
Orange anodized aluminium



A filo in AISI 420 black idrogliider  
Black idrogliider wire clip AISI 420



AISI 303 black idrogliider  
Black idrogliider AISI 303



### FX-604 OD LINER LOCK

Movimento con cuscinetti a sfera  
Ball bearing operating system

135 g - 4,76 oz



19 cm - 7,48"



4 mm - 0,16"



8 cm - 3,14"



N690Co Top Shield® nero  
Black Top Shield® N690Co  
HRC 58-60



FRN® verde OD  
OD green FRN®



AISI 420 black idrogliider  
Black idrogliider AISI 420



Alluminio anodizzato nero  
Black anodized aluminium



A filo in AISI 420 black idrogliider  
Black idrogliider wire clip AISI 420



AISI 303 black idrogliider  
Black idrogliider AISI 303



### FX-604 OR LINER LOCK

Movimento con cuscinetti a sfera  
Ball bearing operating system

135 g - 4,76 oz



19 cm - 7,48"



4 mm - 0,16"



8 cm - 3,14"



N690Co Top Shield® nero  
Black Top Shield® N690Co  
HRC 58-60



FRN® arancione  
Orange FRN®



AISI 420 black idrogliider  
Black idrogliider AISI 420



Alluminio anodizzato nero  
Black anodized aluminium



A filo in AISI 420 black idrogliider  
Black idrogliider wire clip AISI 420



AISI 303 black idrogliider  
Black idrogliider AISI 303



### FX-604 LINER LOCK

Movimento con cuscinetti a sfera  
Ball bearing operating system

135 g - 4,76 oz



19 cm - 7,48"



4 mm - 0,16"



8 cm - 3,14"



N690Co stone washed  
Stone washed N690Co  
HRC 58-60



FRN® nero  
Black FRN®



AISI 420 burattato  
Tumbled AISI 420



Alluminio anodizzato nero  
Black anodized aluminium



A filo in AISI 420 black idrogliider  
Black idrogliider wire clip AISI 420



AISI 303 lucido  
Polished AISI 303



### FX-604 BL LINER LOCK

Movimento con cuscinetti a sfera  
Ball bearing operating system

135 g - 4,76 oz



19 cm - 7,48"



4 mm - 0,16"



8 cm - 3,14"



N690Co stone washed  
Stone washed N690Co  
HRC 58-60



FRN® blu  
Blue FRN®



AISI 420 burattato  
Tumbled AISI 420



Alluminio anodizzato arancione  
Orange anodized aluminium



A filo in AISI 420 lucido  
Polished wire clip AISI 420



AISI 303 lucido  
Polished AISI 303



### FX-604 R LINER LOCK

Movimento con cuscinetti a sfera  
Ball bearing operating system

135 g - 4,76 oz



19 cm - 7,48"



4 mm - 0,16"



8 cm - 3,14"



N690Co stone washed  
Stone washed N690Co  
HRC 58-60



FRN® rosso  
Red FRN®



AISI 420 burattato  
Tumbled AISI 420



Alluminio anodizzato grigio  
Grey anodized aluminium



A filo in AISI 420 lucido  
Polished wire clip AISI 420



AISI 303 lucido  
Polished AISI 303

# FX-624 CORE HUNTER

designed by Vox

## FX-624 OR LINER LOCK

Movimento con cuscinetti a sfera  
Ball bearing operating system

NEW  
ITEM



135 g - 4.76 oz



19 cm - 7.48"



4 mm - 0.16"



8 cm - 3.14"



Becut Top Shield® nero  
Black Top Shield® Becut  
HRC 56-58

FRN® arancione  
Orange FRN®

AISI 420 black idrogliider  
Black idrogliider AISI 420

Alluminio anodizzato arancione  
Orange anodized aluminium

A filo in AISI 420 black idrogliider  
Black idrogliider wire clip AISI 420

AISI 303 black idrogliider  
Black idrogliider AISI 303

Clip in dotazione  
Clip included

Kydex®

## FX-624 B LINER LOCK

Movimento con cuscinetti a sfera  
Ball bearing operating system

NEW  
ITEM



135 g - 4.76 oz



19 cm - 7.48"



4 mm - 0.16"



8 cm - 3.14"



Becut stone washed  
Stone washed Becut  
HRC 56-58

FRN® nero  
Black FRN®

AISI 420 burattato  
Tumbled AISI 420

Alluminio anodizzato arancione  
Orange anodized aluminium

A filo in AISI 420 lucido  
Polished wire clip AISI 420

AISI 303 lucido  
Polished AISI 303

Clip in dotazione  
Clip included

Kydex®

# FX-612 CORE TANTO

designed by Vox



## FX-612 BS LINER LOCK



7,8 cm - 3.07"



4 mm - 0.16"



19 cm - 7.48"



135 g - 4.78 oz

### LAMA | BLADE

N690Co acid stone washed  
Acid stone washed N690Co  
HRC 58-60

### MANICO | HANDLE

FRN® nero  
Black FRN®

### LINER LOCK

AISI 420 burattato  
Tumbled AISI 420

Movimento con cuscinetti a sfera  
Ball bearing operating system

### DISTANZIALE | SPACER

Alluminio anodizzato blu  
Blue anodized aluminium

### CLIP

A filo in AISI 420 lucido  
Polished wire clip AISI 420

### VITI | SCREWS

AISI 303 lucido  
Polished AISI 303



## FX-612 ODS LINER LOCK

Movimento con cuscinetti a sfera  
Ball bearing operating system

### LAMA | BLADE

N690Co acid stone washed  
Acid stone washed  
N690Co  
HRC 58-60

### MANICO | HANDLE

FRN® verde OD  
OD green FRN®

### LINER LOCK

AISI 420 burattato  
Tumbled AISI 420

### DISTANZIALE | SPACER

Alluminio anodizzato  
arancione  
Orange anodized  
aluminium

### CLIP

A filo in AISI 420 lucido  
Polished wire clip AISI 420

### VITI | SCREWS

AISI 303 lucido  
Polished AISI 303



7,8 cm - 3.07"



4 mm - 0.16"



19 cm - 7.48"



135 g - 4.78 oz



## FX-612 BLS LINER LOCK

Movimento con cuscinetti a sfera  
Ball bearing operating system

### LAMA | BLADE

N690Co acid stone washed  
Acid stone washed  
N690Co  
HRC 58-60

### MANICO | HANDLE

FRN® blu  
Blue FRN®

### LINER LOCK

AISI 420 burattato  
Tumbled AISI 420

### DISTANZIALE | SPACER

Alluminio anodizzato grigio  
Grey anodized aluminium

### CLIP

A filo in AISI 420 lucido  
Polished wire clip AISI 420

### VITI | SCREWS

AISI 303 lucido  
Polished AISI 303



7,8 cm - 3.07"



4 mm - 0.16"



19 cm - 7.48"



135 g - 4.78 oz

La serie Core Tanto è stata concepita con lo stesso manico del Core e del Baby Core, ma si distingue per la sua lama Tanto. Questa particolare lama è progettata con una punta robusta per una migliore penetrazione e un bisello principale affilato per garantire la massima precisione.

Questa linea di coltelli è stata progettata con l'obiettivo di offrire strumenti affidabili in qualsiasi ambiente. La robustezza della lama assicura prestazioni eccellenti sia all'aperto che in contesti urbani, rendendo il Core Tanto ideale per una vasta gamma di attività.

The Core Tanto series is designed with the same handle as the Core and Baby Core, but is distinguished by its Tanto blade. This particular blade is designed with a strong tip for better penetration and a sharpened main bevel to ensure maximum precision.

This line of knives is designed with the goal of providing reliable tools in any environment. The robustness of the blade ensures excellent performance both outdoors and in urban settings, making the Core Tanto ideal for a wide range of activities.



135 g - 4.76 oz



19 cm - 7.48"



4 mm - 0.16"



7,8 cm - 3.07"



### FX-612 BB

LINER LOCK

▼ Movimento con cuscinetti a sfera  
Ball bearing operating system



135 g - 4.76 oz



19 cm - 7.48"



4 mm - 0.16"



7,8 cm - 3.07"



### FX-612 ODB

LINER LOCK

▼ Movimento con cuscinetti a sfera  
Ball bearing operating system



135 g - 4.76 oz



19 cm - 7.48"



4 mm - 0.16"



7,8 cm - 3.07"



### FX-612 BLB

LINER LOCK

▼ Movimento con cuscinetti a sfera  
Ball bearing operating system



135 g - 4.76 oz



19 cm - 7.48"



4 mm - 0.16"



7,8 cm - 3.07"



### FX-612 RB

LINER LOCK

▼ Movimento con cuscinetti a sfera  
Ball bearing operating system



135 g - 4.76 oz



19 cm - 7.48"



4 mm - 0.16"



7,8 cm - 3.07"



### FX-612 ORB

LINER LOCK

▼ Movimento con cuscinetti a sfera  
Ball bearing operating system



N690Co black idrogliider stone washed  
Black idrogliider stone washed N690Co  
HRC 58-60



FRN® nero  
Black FRN®



AISI 420 black idrogliider  
Black idrogliider AISI 420



Alluminio anodizzato nero  
Black anodized aluminium



A filo in AISI 420 black idrogliider  
Black idrogliider wire clip AISI 420



AISI 303 black idrogliider  
Black idrogliider AISI 303



N690Co black idrogliider stone washed  
Black idrogliider stone washed N690Co  
HRC 58-60



FRN® verde OD  
OD green FRN®



AISI 420 black idrogliider  
Black idrogliider AISI 420



Alluminio anodizzato nero  
Black anodized aluminium



A filo in AISI 420 black idrogliider  
Black idrogliider wire clip AISI 420



AISI 303 black idrogliider  
Black idrogliider AISI 303



N690Co black idrogliider stone washed  
Black idrogliider stone washed N690Co  
HRC 58-60



FRN® blu  
Blue FRN®



AISI 420 black idrogliider  
Black idrogliider AISI 420



Alluminio anodizzato nero  
Black anodized aluminium



A filo in AISI 420 black idrogliider  
Black idrogliider wire clip AISI 420



AISI 303 black idrogliider  
Black idrogliider AISI 303



N690Co black idrogliider stone washed  
Black idrogliider stone washed N690Co  
HRC 58-60



FRN® rosso  
Red FRN®



AISI 420 black idrogliider  
Black idrogliider AISI 420



Alluminio anodizzato nero  
Black anodized aluminium



A filo in AISI 420 black idrogliider  
Black idrogliider wire clip AISI 420



AISI 303 black idrogliider  
Black idrogliider AISI 303



N690Co black idrogliider stone washed  
Black idrogliider stone washed N690Co  
HRC 58-60



FRN® arancione  
Orange FRN®



AISI 420 black idrogliider  
Black idrogliider AISI 420



Alluminio anodizzato nero  
Black anodized aluminium



A filo in AISI 420 black idrogliider  
Black idrogliider wire clip AISI 420



AISI 303 black idrogliider  
Black idrogliider AISI 303

### FX-530 TIDSW CHILIN

designed by Vox

Lunghezza lama / Blade length 8 cm - 3.15"  
Spessore lama / Blade thickness 4 mm - 0.16"  
Lunghezza totale / Total length 19,3 cm - 7.60"  
Peso / Weight 145 g - 5.11 oz

#### LINER LOCK

Movimento con cuscinetti a sfera  
Ball bearing operating system



Cuoio nero  
Black leather

- M398 PVD nero stone washed  
Black PVD stone washed M398  
HRC 60-61
- Titanio PVD nero stone washed  
Black PVD stone washed titanium
- AISI 420 black idroglider  
Black idroglider AISI 420
- Titanio anodizzato bronzo  
Bronze anodized titanium
- A filo in AISI 420 PVD nero  
Black PVD wire clip AISI 420
- AISI 303 PVD nero  
Black PVD AISI 303



### FX-530 TIASW CHILIN

designed by Vox

Lunghezza lama / Blade length 8 cm - 3.15"  
Spessore lama / Blade thickness 4 mm - 0.16"  
Lunghezza totale / Total length 19,3 cm - 7.60"  
Peso / Weight 150 g - 5.29 oz

#### LINER LOCK

Movimento con cuscinetti a sfera  
Ball bearing operating system



Cuoio nero  
Black leather

- M398 coarse stone washed  
Coarse stone washed M398  
HRC 60-61
- Titanio coarse stone washed  
Coarse stone washed titanium
- AISI 420 sabbaiato  
Sandblasted AISI 420
- Titanio coarse stone washed  
Coarse stone washed titanium
- A filo in AISI 420 sabbaiato  
Sandblasted wire clip AISI 420
- AISI 303 sabbaiato  
Sandblasted AISI 303



### FX-530 MOD CHILIN

designed by Vox

Lunghezza lama / Blade length 8 cm - 3.15"  
Spessore lama / Blade thickness 4 mm - 0.16"  
Lunghezza totale / Total length 19,3 cm - 7.60"  
Peso / Weight 105 g - 3.70 oz

#### LINER LOCK

Movimento con cuscinetti a sfera  
Ball bearing operating system



Cuoio nero  
Black leather

- M398 stone washed  
Stone washed M398  
HRC 60-61
- Micarta verde OD sabbaiato  
Sandblasted OD green Micarta
- AISI 420 sabbaiato  
Sandblasted AISI 420
- Titanio coarse stone washed  
Coarse stone washed titanium
- A filo in AISI 420 sabbaiato  
Sandblasted wire clip AISI 420
- AISI 303 sabbaiato  
Sandblasted AISI 303



### FX-530 ALOD CHILIN

designed by Vox

Lunghezza lama / Blade length 8 cm - 3.15"  
Spessore lama / Blade thickness 4 mm - 0.16"  
Lunghezza totale / Total length 19,3 cm - 7.60"  
Peso / Weight 117,5 g - 4.15 oz

#### LINER LOCK

Movimento con cuscinetti a sfera  
Ball bearing operating system



Nylon®

- N690Co black idroglider stone washed  
Black idroglider stone washed N690Co  
HRC 58-60
- Alluminio anodizzato verde OD  
OD green anodized aluminium
- AISI 420 black idroglider  
Black idroglider AISI 420
- Alluminio anodizzato nero  
Black anodized aluminium
- A filo in AISI 420 black  
idroglider  
Black idroglider wire clip  
AISI 420
- AISI 303 black idroglider  
Black idroglider AISI 303



### FX-530 CFDSW CHILIN

designed by Vox

Lunghezza lama / Blade length 8 cm - 3.15"  
Spessore lama / Blade thickness 4 mm - 0.16"  
Lunghezza totale / Total length 19,3 cm - 7.60"  
Peso / Weight 107,5 g - 3.79 oz

#### LINER LOCK

Movimento con cuscinetti a sfera  
Ball bearing operating system



Cuoio nero  
Black leather

- M398 PVD nero stone washed  
Black PVD stone washed M398  
HRC 60-61
- Fibra di carbonio 3K  
3K carbon fiber
- AISI 420 black idroglider  
Black idroglider AISI 420
- Titanio anodizzato bronzo  
Bronze anodized titanium
- A filo in AISI 420 PVD nero  
Black PVD wire clip AISI 420
- AISI 303 PVD nero  
Black PVD AISI 303



### FX-530 CF CHILIN

designed by Vox

Lunghezza lama / Blade length 8 cm - 3.15"  
Spessore lama / Blade thickness 4 mm - 0.16"  
Lunghezza totale / Total length 19,3 cm - 7.60"  
Peso / Weight 106 g - 3.78 oz

#### LINER LOCK

Movimento con cuscinetti a sfera  
Ball bearing operating system



Cuoio nero  
Black leather

- M398 satinato  
Satin M398  
HRC 60-61
- Fibra di carbonio 3K  
3K carbon fiber
- AISI 420 black idroglider  
Black idroglider AISI 420
- Titanio anodizzato blu  
Blue anodized titanium
- A filo in AISI 420 PVD nero  
Black PVD wire clip AISI 420
- AISI 303 PVD nero  
Black PVD AISI 303



### FX-530 ALBL CHILIN

designed by Vox

Lunghezza lama / Blade length 8 cm - 3.15"  
Spessore lama / Blade thickness 4 mm - 0.16"  
Lunghezza totale / Total length 19,3 cm - 7.60"  
Peso / Weight 117,5 g - 4.15 oz

#### LINER LOCK

Movimento con cuscinetti a sfera  
Ball bearing operating system



Nylon®

- N690Co stone washed  
Stone washed N690Co  
HRC 58-60
- Alluminio anodizzato blu  
Blue anodized aluminium
- AISI 420 black idroglider  
Black idroglider AISI 420
- Alluminio anodizzato grigio  
Grey anodized aluminium
- A filo in AISI 420 black  
idroglider  
Black idroglider wire clip  
AISI 420
- AISI 303 black idroglider  
Black idroglider AISI 303



### FX-530 G10B CHILIN

designed by Vox

Lunghezza lama / Blade length 8 cm - 3.15"  
Spessore lama / Blade thickness 4 mm - 0.16"  
Lunghezza totale / Total length 19,3 cm - 7.60"  
Peso / Weight 110 g - 3.88 oz

#### LINER LOCK

Movimento con cuscinetti a sfera  
Ball bearing operating system



Nylon®

- N690Co stone washed  
Stone washed N690Co  
HRC 58-60
- G10 nero  
Black G10
- AISI 420 black idroglider  
Black idroglider AISI 420
- Alluminio anodizzato giallo lime  
Yellow lime anodized aluminium
- A filo in AISI 420 black  
idroglider  
Black idroglider wire clip  
AISI 420
- AISI 303 black idroglider  
Black idroglider AISI 303



**HONOS**

designed by Bastinelli

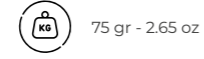
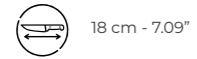
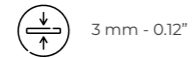
**FX-538 MP**  
LINER LOCK**LAMA | BLADE**Becut PVD nero stone washed  
Black PVD stone washed  
Becut  
HRC 56-58**DISTANZIALE | SPACER**AISI 420 black idrogliider  
Black idrogliider AISI 420**VITI | SCREWS**AISI 420 black idrogliider  
Black idrogliider AISI 420**MANICO | HANDLE**Micarta plum  
Plum Micarta**LINER LOCK**AISI 420 black idrogliider  
Black idrogliider AISI 420Cuoiu nero  
Black leather**HONOS**

designed by Bastinelli

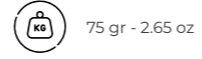
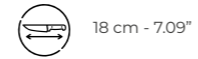
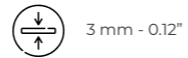
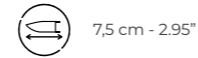
**FX-538 G10B**  
LINER LOCK**LAMA | BLADE**Becut stone washed  
Stone washed Becut  
HRC 56-58**DISTANZIALE | SPACER**AISI 303 burattato  
Tumbled AISI 303**VITI | SCREWS**AISI 303 lucido  
Polished AISI 303**MANICO | HANDLE**G10 nero  
Black G10**LINER LOCK**AISI 420 burattato  
Tumbled AISI 420Cuoiu nero  
Black leather**FIDES**

designed by Bastinelli

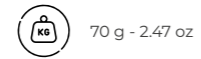
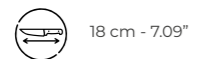
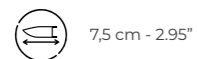
**FX-539 ST**  
SLIP JOINT**LAMA | BLADE**Becut satinato  
Satin Becut  
HRC 56-58**DISTANZIALE | SPACER**AISI 303 burattato  
Tumbled AISI 303**VITI | SCREWS**AISI 303 lucido  
Polished AISI 303**MANICO | HANDLE**Santos  
Santos wood**LINER LOCK**AISI 420 burattato  
Tumbled AISI 420Cuoiu marrone  
Brown leather**FIDES**

designed by Bastinelli

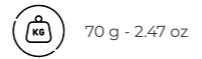
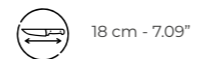
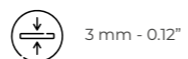
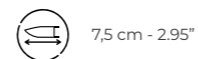
**FX-539 OL**  
SLIP JOINT**LAMA | BLADE**Becut satinato  
Satin Becut  
HRC 56-58**DISTANZIALE | SPACER**AISI 303 burattato  
Tumbled AISI 303**VITI | SCREWS**AISI 303 lucido  
Polished AISI 303**MANICO | HANDLE**Oливо  
Olive wood**LINER LOCK**AISI 420 burattato  
Tumbled AISI 420Cuoiu marrone  
Brown leatherCuoiu nero  
Black leather**SHADOW**

designed by Bastinelli

**FX-533 CF**  
FRAME LOCKMovimento con cuscinetti a sfera  
Ball bearing operating system

140 g - 4.93 oz

Elmax stone washed  
Stone washed Elmax  
HRC 58-60Fibra di carbonio  
Carbon fiberTitanio stone washed  
Stone washed titaniumG10 nero  
Black G10Sagomata in AISI 420 stone washed  
Stone washed shaped AISI 420AISI 303 lucido  
Polished AISI 303

Nylon®

**GECO**

designed by Bastinelli

**FX-537 SW**  
FRAME LOCKMovimento con cuscinetti a sfera  
Ball bearing operating system

129 g - 4.55 oz

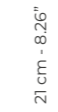
N690Co acid stone washed  
Acid stone washed N690Co  
HRC 58-60Micarta verde OD  
OD green MicartaTitanio stone washed  
Stone washed titaniumG10 nero  
Black G10Sagomata in AISI 420 stone washed  
Stone washed shaped AISI 420AISI 303 sabbiato  
Sandblasted AISI 303

Nylon®

**GECO**

designed by Bastinelli

**FX-537 BR**  
FRAME LOCKMovimento con cuscinetti a sfera  
Ball bearing operating system

129 g - 4.55 oz

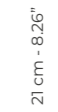
N690Co black idrogliider stone washed  
Black idrogliider stone washed N690Co  
HRC 58-60G10 nero  
Black G10Titanio anodizzato bronzo  
Bronze anodized titaniumG10 nero  
Black G10Sagomata in AISI 420 black  
idrogliider stone washed  
Black idrogliider stone washed  
shaped AISI 420AISI 303 rivestito al nichel  
Nickel plated AISI 303

# FX-518

## SLIM DRAGOTAC "PIEMONTES"

designed by Bastinelli



75 g - 2.65 oz



18,5 cm - 7.28"



3 mm - 0.12"



8 cm - 3.15"



Fodero in cuoio sagomato marrone  
Brown contoured leather sheath

### FX-518 ZW FRICTION FOLDER



N690Co satinato  
Satin N690Co  
HRC 58-60

Zircote  
Zircote wood

AISI 420 lucido  
Polished AISI 420

AISI 303 lucido  
Polished AISI 303



Fodero in cuoio sagomato nero  
Black contoured leather sheath

### FX-518 O FRICTION FOLDER



45 g - 1.6 oz



18,5 cm - 7.28"



3 mm - 0.12"



8 cm - 3.15"



N690Co satinato  
Satin N690Co  
HRC 58-60

FRN® arancione  
Orange FRN®

AISI 420 lucido  
Polished AISI 420

AISI 303 lucido  
Polished AISI 303

# BB DRAGO "PIEMONTES"

designed by Bastinelli



Fodero in cuoio  
sagomato nero  
Black contoured  
leather sheath

### FX-519 FRICTION FOLDER

**LAMA | BLADE**  
N690Co satinato  
Satin N690Co  
HRC 58-60

**MANICO | HANDLE**  
FRN® nero  
Black FRN®

**DISTANZIALE | SPACER**  
AISI 420 lucido  
Polished AISI 420

**VITI | SCREWS**  
AISI 303 lucido  
Polished AISI 303

4,5 cm - 1.77"

3 mm - 0.12"

10,5 cm - 4.13"

30 g - 1.05 oz



Fodero in cuoio  
sagomato nero  
Black contoured  
leather sheath

### FX-519 GR FRICTION FOLDER

**LAMA | BLADE**  
N690Co satinato  
Satin N690Co  
HRC 58-60

**MANICO | HANDLE**  
FRN® grigio  
Grey FRN®

**DISTANZIALE | SPACER**  
AISI 420 lucido  
Polished AISI 420

**VITI | SCREWS**  
AISI 303 lucido  
Polished AISI 303

4,5 cm - 1.77"

3 mm - 0.12"

10,5 cm - 4.13"

30 g - 1.05 oz

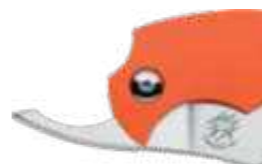

Fodero in cuoio  
sagomato nero  
Black contoured  
leather sheath

### FX-519 O FRICTION FOLDER

**LAMA | BLADE**  
N690Co satinato  
Satin N690Co  
HRC 58-60

**MANICO | HANDLE**  
FRN® arancione  
Orange FRN®

**DISTANZIALE | SPACER**  
AISI 420 lucido  
Polished AISI 420

**VITI | SCREWS**  
AISI 303 lucido  
Polished AISI 303

4,5 cm - 1.77"

3 mm - 0.12"

10,5 cm - 4.13"

30 g - 1.05 oz



Fodero in cuoio  
sagomato marrone  
Brown contoured  
leather sheath

### FX-519 ZW FRICTION FOLDER

**LAMA | BLADE**  
N690Co satinato  
Satin N690Co  
HRC 58-60

**MANICO | HANDLE**  
Zircote  
Zircote wood

**DISTANZIALE | SPACER**  
AISI 420 lucido  
Polished AISI 420

**VITI | SCREWS**  
AISI 303 lucido  
Polished AISI 303

4,5 cm - 1.77"

3 mm - 0.12"

10,5 cm - 4.13"

30 g - 1.05 oz

# FX-543

## CHNOPS

designed by Raven Knives Design

Il Chnops ha un design pulito che estremizza le forme, un liner lock compatto pensato principalmente come EDC da utilizzare anche come accessorio da portare nel taschino della camicia. Il front flipper permette alla lama con cuscinetti a sfera di scivolare in posizione; il meccanismo è interamente nascosto dalle guancette dei manici in fibra di carbonio, di titanio o di alluminio.

Il nome è l'acronimo degli elementi maggiormente presenti in chimica organica alla base della materia vivente, ovvero: carbonio (C), idrogeno (H), azoto (N), ossigeno (O), fosforo (P) e zolfo (S).

The Chnops has a clean design that takes shapes to extremes, a compact liner lock designed primarily as an EDC that can also be used as an accessory to carry in the shirt pocket. The front flipper allows the ball-bearing blade to slide into place; the mechanism is entirely hidden by the carbon fiber, titanium or aluminum handle scales.

The name stands for the elements most commonly found in organic chemistry at the basis of living matter, namely: carbon (C), hydrogen (H), nitrogen (N), oxygen (O), phosphorus (P) and sulfur (S).



Cuoio nero  
Black leather



Cuoio nero  
Black leather



### FX-543 CFBR

#### LINER LOCK

▼ Movimento con cuscinetti a sfera  
Ball bearing operating system

78 g - 2.75 oz



18 cm - 7.8"



3.5 mm - 0.14"



7.5 cm - 2.95"



M390 PVD nero  
Black PVD M390  
HRC 59-61



Fibra di carbonio 3K  
3K carbon fiber



AISI 420 burattato  
Tumbled AISI 420



Titanio anodizzato bronzo  
Bronze anodized titanium



Sagomata in titanio anodizzato bronzo  
Bronze anodized shaped titanium



Titanio anodizzato bronzo  
Bronze anodized titanium

### FX-543 CFO

#### LINER LOCK

▼ Movimento con cuscinetti a sfera  
Ball bearing operating system

78 g - 2.75 oz



18 cm - 7.8"



3.5 mm - 0.14"



7.5 cm - 2.95"



M390 satinato  
Satin M390  
HRC 59-61



Fibra di carbonio 3K  
3K carbon fiber



AISI 420 burattato  
Tumbled AISI 420



Alluminio anodizzato arancione  
Orange anodized aluminium



Sagomata in AISI 420 lucido  
Polished shaped AISI 420



AISI 303 lucido  
Polished AISI 303

### FX-543 ALB

#### LINER LOCK

▼ Movimento con cuscinetti a sfera  
Ball bearing operating system

78 g - 2.75 oz



18 cm - 7.8"



3.5 mm - 0.14"



7.5 cm - 2.95"



Becut Top Shield® nero  
Black Top Shield® Becut  
HRC 56-58



Alluminio anodizzato nero  
Black anodized aluminium



AISI 420 black idrogliider  
Black idrogliider AISI 420



Alluminio anodizzato nero  
Black anodized aluminium



Sagomata in AISI 420 black idrogliider  
Black idrogliider shaped AISI 420



AISI 303 black idrogliider  
Black idrogliider AISI 303

### FX-543 ALG

#### LINER LOCK

▼ Movimento con cuscinetti a sfera  
Ball bearing operating system

78 g - 2.75 oz



18 cm - 7.8"



3.5 mm - 0.14"



7.5 cm - 2.95"



Becut Top Shield® nero  
Black Top Shield® Becut  
HRC 56-58



Alluminio anodizzato verde OD  
OD green anodized aluminium



AISI 420 black idrogliider  
Black idrogliider AISI 420



Alluminio anodizzato nero  
Black anodized aluminium



Sagomata in AISI 420 black idrogliider  
Black idrogliider shaped AISI 420



AISI 303 black idrogliider  
Black idrogliider AISI 303

### FX-543 ALO

#### LINER LOCK

▼ Movimento con cuscinetti a sfera  
Ball bearing operating system

78 g - 2.75 oz



18 cm - 7.8"



3.5 mm - 0.14"



7.5 cm - 2.95"



Becut Top Shield® nero  
Black Top Shield® Becut  
HRC 56-58



Alluminio anodizzato arancione  
Orange anodized aluminium



AISI 420 black idrogliider  
Black idrogliider AISI 420



Alluminio anodizzato nero  
Black anodized aluminium



Sagomata in AISI 420 black idrogliider  
Black idrogliider shaped AISI 420



AISI 303 black idrogliider  
Black idrogliider AISI 303



# FX-524 EASTWOOD TIGER

designed by Gudy Van Poppel



## FX-524 TI FRAME LOCK



9,5 cm - 3.7"



4 mm - 0.16"



22,7 cm - 8.9"



200 g - 7.05 oz

### LAMA | BLADE

CPM S90V PVD nero  
Black PVD CPM S90V  
HRC 59-61

### MANICO | HANDLE

Titanio PVD nero  
Black PVD titanium

### FRAME LOCK

Titanio PVD nero  
Black PVD titanium

▼  
Movimento con cuscinetti a sfera  
Ball bearing operating system

### DISTANZIALE | SPACER

Titanio anodizzato blu  
Blue anodized titanium

### CLIP

Sagomata in titanio anodizzato blu  
Blue anodized shaped titanium

### VITI | SCREWS

Titanio anodizzato blu  
Blue anodized titanium



Cuoio nero  
Black leather



Cuoio nero  
Black leather

## FX-524 TICF FRAME LOCK

▼  
Movimento con cuscinetti a sfera  
Ball bearing operating system

### LAMA | BLADE

Coarse stone washed  
CPM S90V  
HRC 59-61

**MANICO | HANDLE**  
Titanio sabbato + inserto  
fibra di carbonio 3K  
Sandblasted titanium +  
3K carbon fiber insert

**FRAME LOCK**  
Titanio sabbato  
Sandblasted titanium

### DISTANZIALE | SPACER

Titanio anodizzato bronzo  
Bronze anodized titanium

**CLIP**  
Sagomata in titanio  
anodizzato bronzo  
Bronze anodized shaped  
titanium

**VITI | SCREWS**  
Titanio anodizzato bronzo  
Bronze anodized titanium



9,5 cm - 3.7"



4 mm - 0.16"



22,7 cm - 8.9"



190 g - 6.70 oz



Cuoio nero  
Black leather

## FX-524 TIZW FRAME LOCK

▼  
Movimento con cuscinetti a sfera  
Ball bearing operating system

### LAMA | BLADE

CPM S90V satinato  
Satin CPM S90V  
HRC 59-61

**MANICO | HANDLE**  
Titanio anodizzato bronzo  
+ inserto in Ziricote  
Bronze anodized titanium  
+ Ziricote wood insert

**FRAME LOCK**  
Titanio anodizzato bronzo  
Bronze anodized titanium

### DISTANZIALE | SPACER

Titanio sabbato  
Sandblasted titanium

**CLIP**  
Sagomata in titanio  
sabbato  
Sandblasted shaped  
titanium

**VITI | SCREWS**  
Titanio lucido  
Polished titanium



9,5 cm - 3.7"



4 mm - 0.16"



22,7 cm - 8.9"



185 g - 6.52 oz



Cuoio, Feltro e Nylon®  
Leather, Felt and Nylon®



Cuoio, Feltro e Nylon®  
Leather, Felt and Nylon®



Cuoio, Feltro e Nylon®  
Leather, Felt and Nylon®



Cuoio, Feltro e Nylon®  
Leather, Felt and Nylon®



Cuoio, Feltro e Nylon®  
Leather, Felt and Nylon®



Cuoio, Feltro e Nylon®  
Leather, Felt and Nylon®

152 gr - 5.36 oz



22,7 cm - 8.9"

4 mm - 0.16"

9,5 cm - 3.7"

### FX-524 ZW LINER LOCK

Movimento con cuscinetti a sfera  
Ball bearing operating system



150 gr - 5.29 oz



22,7 cm - 8.9"

4 mm - 0.16"

9,5 cm - 3.7"

### FX-524 OL LINER LOCK

Movimento con cuscinetti a sfera  
Ball bearing operating system



155 gr - 5.46 oz



22,7 cm - 8.9"

4 mm - 0.16"

9,5 cm - 3.7"

### FX-524 MB LINER LOCK

Movimento con cuscinetti a sfera  
Ball bearing operating system



155 gr - 5.46 oz



22,7 cm - 8.9"

4 mm - 0.16"

9,5 cm - 3.7"

### FX-524 MJ LINER LOCK

Movimento con cuscinetti a sfera  
Ball bearing operating system



165 gr - 5.82 oz



22,7 cm - 8.9"

4 mm - 0.16"

9,5 cm - 3.7"

### FX-524 G LINER LOCK

Movimento con cuscinetti a sfera  
Ball bearing operating system



175 gr - 6.17 oz



22,7 cm - 8.9"

4 mm - 0.16"

9,5 cm - 3.7"

### FX-524 B LINER LOCK

Movimento con cuscinetti a sfera  
Ball bearing operating system



CPM S90V satinato  
Satin CPM S90V  
HRC 59-61



Ziricote  
Ziricote wood



AISI 420 burattato  
Tumbled AISI 420



Alluminio anodizzato marrone  
Brown anodized aluminium



Sagomata in AISI 420 burattato  
Tumbled shaped AISI 420



AISI 303 lucido  
Polished AISI 303



CPM S90V satinato  
Satin CPM S90V  
HRC 59-61



Olivo  
Olive wood



AISI 420 burattato  
Tumbled AISI 420



Alluminio anodizzato marrone  
Brown anodized aluminium



Sagomata in AISI 420 burattato  
Tumbled shaped AISI 420



AISI 303 lucido  
Polished AISI 303



CPM S90V black idroglider stone washed  
Black idroglider stone washed CPM S90V  
HRC 59-61



Micarta borgogna  
Burgundy Micarta



AISI 420 black idroglider  
Black idroglider AISI 420



Alluminio anodizzato nero  
Black anodized aluminium



Sagomata in AISI 420 black idroglider  
Black idroglider shaped AISI 420



AISI 303 black idroglider  
Black idroglider AISI 303



CPM S90V coarse stone washed  
Coarse stone washed CPM S90V  
HRC 59-61



Micarta denim



AISI 420 burattato  
Tumbled AISI 420



Alluminio anodizzato grigio  
Grey anodized aluminium



Sagomata in AISI 420 burattato  
Tumbled shaped AISI 420



AISI 303 lucido  
Polished AISI 303



D2 stone washed  
Stone washed D2  
HRC 59-61



Micarta verde OD  
OD green Micarta



AISI 420 lucido  
Polished AISI 420



Alluminio anodizzato bronzo  
Bronze anodized aluminium



Sagomata in AISI 420 stone washed  
Stone washed shaped AISI 420



AISI 303 lucido  
Polished AISI 303



D2 black idroglider stone washed  
Black idroglider stone washed D2  
HRC 59-61



G10 nero  
Black G10



AISI 420 black idroglider  
Black idroglider AISI 420



Alluminio anodizzato grigio  
Grey anodized aluminium



Sagomata in AISI 420 black idroglider  
Black idroglider shaped AISI 420



AISI 303 black idroglider  
Black idroglider AISI 303

**FX-F2017**

## ANNIVERSARY KNIFE 1977-2017

**FX-F2017 D**  
FRAME LOCK**LAMA | BLADE**

Cysinge™ by Damasteel®  
HRC 58-60

**MANICO | HANDLE**

Fibra di carbonio Marble +  
mostrine titanio anodizzato blu  
Marble carbon fiber + blue  
anodized titanium bolsters

**FRAME LOCK**

Titanio anodizzato blu  
Blue anodized titanium

▼  
Movimento con cuscinetti a sfera  
Ball bearing operating system

**DISTANZIALE | SPACER**

Titanio anodizzato blu  
Blue anodized titanium

**CLIP**

Sagomata in titanio  
anodizzato blu  
Blue anodized shaped  
titanium



Espositore  
Display

**VITI | SCREWS**

Titanio anodizzato blu  
Blue anodized titanium

**FX-F2017 R**  
FRAME LOCK

▼  
Movimento con cuscinetti a sfera  
Ball bearing operating system

**LAMA | BLADE**

M390 PVD nero  
Black PVD M390  
HRC 59-61

**MANICO | HANDLE**

Fibra di carbonio Marble +  
mostrine titanio PVD nero  
Marble carbon fiber +  
black PVD titanium  
bolsters

**FRAME LOCK**

Titanio PVD nero  
Black PVD titanium

**DISTANZIALE | SPACER**

Titanio PVD nero  
Black PVD titanium

**CLIP**

Sagomata in titanio PVD nero  
Black PVD shaped titanium

**VITI | SCREWS**

Titanio PVD nero  
Black PVD titanium

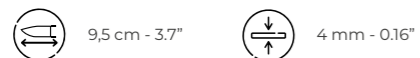
**FX-F2017**  
FRAME LOCK

▼  
Movimento con cuscinetti a sfera  
Ball bearing operating system

**LAMA | BLADE**

M390 satinato  
Satin M390  
HRC 59-61

**MANICO | HANDLE**

Marble carbon fiber +  
mostrine titanio sabbato  
Marble carbon fiber +  
sandblasted titanium  
bolsters

**FRAME LOCK**

Titanio sabbato  
Sandblasted titanium

**DISTANZIALE | SPACER**

Titanio sabbato  
Sandblasted titanium

**CLIP**

Sagomata in titanio sabbato  
Sandblasted shaped titanium

**VITI | SCREWS**

Titanio lucido  
Polished titanium





### NEW SMARTY FX-503SP B

AUTOMATIC  
Con blocco di sicurezza  
With Safety lock

**LAMA | BLADE**  
N690Co PVD nero  
Black PVD N690Co  
HRC 58-60

**DISTANZIALE | SPACER**  
AISI 420 black idroglied  
Black idroglied AISI 420

**MANICO | HANDLE**  
Alluminio anodizzato nero  
Black anodized  
aluminium

**CLIP**  
Sagomata in AISI 420 black  
idroglied  
Black idroglied shaped  
AISI 420

**APERTURA | OPENING**  
AISI 420 black idroglied  
Black idroglied AISI 420

**VITI | SCREWS**  
AISI 303 black idroglied  
Black idroglied AISI 303



8 cm - 3,15"

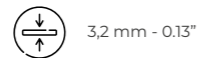

3,2 mm - 0.13"



19,3 cm - 7.59"



121 g - 4.26 oz



Nylon®



### NEW SMARTY FX-503SP OD

AUTOMATIC  
Con blocco di sicurezza  
With Safety lock

**LAMA | BLADE**  
N690Co stone washed  
Stone washed N690Co  
HRC 58-60

**DISTANZIALE | SPACER**  
AISI 420 lucido  
Polished AISI 420

**MANICO | HANDLE**  
Alluminio anodizzato  
verde OD  
OD green anodized  
aluminium

**CLIP**  
Sagomata in AISI 420 stone  
washed  
Stone washed shaped  
AISI 420

**APERTURA | OPENING**  
AISI 420 lucido  
Polished AISI 420

**VITI | SCREWS**  
AISI 303 lucido  
Polished AISI 303



8 cm - 3,15"

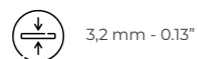

3,2 mm - 0.13"



19,3 cm - 7.59"



121 g - 4.26 oz



### NEW SMARTY FX-503 ALB

AUTOMATIC  
Con blocco di sicurezza  
With Safety lock

**LAMA | BLADE**  
N690Co PVD nero  
Black PVD N690Co  
HRC 58-60

**DISTANZIALE | SPACER**  
AISI 420 black idroglied  
Black idroglied AISI 420

**MANICO | HANDLE**  
Alluminio anodizzato nero  
Black anodized  
aluminium

**CLIP**  
Sagomata in AISI 420 black  
idroglied  
Black idroglied shaped  
AISI 420

**APERTURA | OPENING**  
AISI 420 black idroglied  
Black idroglied AISI 420

**VITI | SCREWS**  
AISI 303 black idroglied  
Black idroglied AISI 303



8 cm - 3,15"

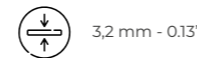

3,2 mm - 0.13"



19,3 cm - 7.59"



119 g - 4.19 oz



Nylon®

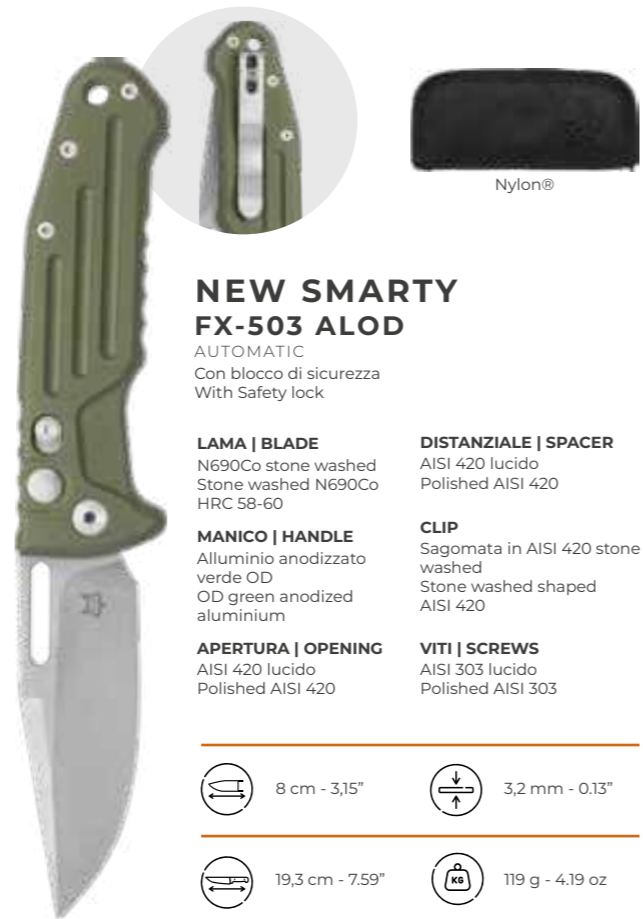

### NEW SMARTY FX-503 ALOD

AUTOMATIC  
Con blocco di sicurezza  
With Safety lock

**LAMA | BLADE**  
N690Co stone washed  
Stone washed N690Co  
HRC 58-60

**DISTANZIALE | SPACER**  
AISI 420 lucido  
Polished AISI 420

**MANICO | HANDLE**  
Alluminio anodizzato  
verde OD  
OD green anodized  
aluminium

**CLIP**  
Sagomata in AISI 420 stone  
washed  
Stone washed shaped  
AISI 420

**APERTURA | OPENING**  
AISI 420 lucido  
Polished AISI 420

**VITI | SCREWS**  
AISI 303 lucido  
Polished AISI 303



8 cm - 3,15"

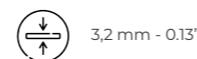

3,2 mm - 0.13"



19,3 cm - 7.59"



119 g - 4.19 oz

## FX-570 PHI

designed by Fiore Knives



### FX-570 TiD BALISONG

**LAMA | BLADE**  
Dense Twist™ by Damasteel®  
HRC 58-60

**MANICO | HANDLE**  
Titanio anodizzato bronzo  
Bronze anodized titanium

**VITI | SCREWS**  
Titanio PVD nero  
Black PVD titanium



12,6 cm - 4.96"



4 mm - 0.16"



25,5 cm - 10"



139 g - 4.92 oz

#### PACKAGING

Scatola grigia per modelli  
in titanio  
Grey box for titanium  
models

Scatola nera per modello in  
damasco  
Black box for damascus  
model



Cuoio nero  
Black leather



### FX-570 TiB BALISONG

**LAMA | BLADE**  
M390 PVD nero  
Black PVD M390  
HRC 59-91

**MANICO | HANDLE**  
Titanio PVD nero  
Black PVD titanium

**VITI | SCREWS**  
Titanio anodizzato bronzo  
Bronze anodized titanium



12,6 cm - 4.96"



4 mm - 0.16"



25,5 cm - 10"



139 g - 4.92 oz



Cuoio nero  
Black leather



### FX-570 Ti BALISONG

**LAMA | BLADE**  
M390 satinato  
Satin M390  
HRC 59-91

**MANICO | HANDLE**  
Titanio sabbato  
Sandblasted titanium

**VITI | SCREWS**  
Titanio  
Titanium



12,6 cm - 4.96"



4 mm - 0.16"



25,5 cm - 10"



139 g - 4.92 oz



Cuoio nero  
Black leather

# FX-557 URO

designed by Dino Picco  
in collaboration with  
Wander Tactical

Insieme al coltello viene fornito un perno filettato appositamente progettato per garantirne la massima sicurezza, consentendone l'utilizzo come coltello a lama fissa e impedendone la chiusura accidentale.

A specially designed threaded pin is supplied with the knife to ensure maximum safety, allowing it to be used as a fixed blade knife and preventing accidental closure.



## FX-557 LINER LOCK

NEW  
ITEM



9 cm - 3.54"



4 mm - 0.16"



22 cm - 8.66"



220 g - 7.76 oz

**LAMA | BLADE**  
Acid washed Niolox  
HRC 59-61

**MANICO | HANDLE**  
Micarta verde OD  
OD green Micarta

**LINER LOCK**  
AISI 420 sabbiato  
Sandblasted AISI 420

▼  
Movimento con cuscinetti a sfera  
Ball bearing operating system

**DISTANZIALE | SPACER**  
G10 nero  
Black G10

**CLIP**  
Sagomata in AISI 420 sabbiato  
Sandblasted shaped AISI 420

**VITI | SCREWS**  
AISI 303 sabbiato  
Sandblasted AISI 303



Nylon®



## FX-557 B LINER LOCK

NEW  
ITEM



9 cm - 3.54"



4 mm - 0.16"



22 cm - 8.66"



230 g - 8.11 oz

**LAMA | BLADE**  
Niolox PVD nero  
Black PVD Niolox  
HRC 59-61

**MANICO | HANDLE**  
G10 nero  
Black G10

**LINER LOCK**  
AISI 420 black idrogliider  
Black idrogliider AISI 420

▼  
Movimento con cuscinetti a sfera  
Ball bearing operating system

**DISTANZIALE | SPACER**  
G10 nero  
Black G10

**CLIP**  
Sagomata in AISI 420 black idrogliider  
Black idrogliider shaped AISI 420

**VITI | SCREWS**  
AISI 303 black idrogliider  
Black idrogliider AISI 303



Nylon®



# FX-540 ITALICO

designed by Antonio Di Gennaro



Cuoio nero  
Black leather



Cuoio nero  
Black leather



Nylon®



Nylon®

## FX-540 B LINER LOCK

Movimento con cuscinetti a sfera  
Ball bearing operating system

78 g - 2.75 oz



15 cm - 5.9"



3 mm - 0.12"



6 cm - 2.36"



## FX-540 OD LINER LOCK

Movimento con cuscinetti a sfera  
Ball bearing operating system

78 g - 2.75 oz



15 cm - 5.9"



3 mm - 0.12"



6 cm - 2.36"



## FX-540 TIB FRAME LOCK

Movimento con cuscinetti a sfera  
Ball bearing operating system

90 g - 3.35 oz



15 cm - 5.9"



3 mm - 0.12"



6 cm - 2.36"



## FX-540 TIBL FRAME LOCK

Movimento con cuscinetti a sfera  
Ball bearing operating system

90 g - 3.35 oz



15 cm - 5.9"



3 mm - 0.12"



6 cm - 2.36"



## FX-540 NA LINER LOCK

Movimento con cuscinetti a sfera  
Ball bearing operating system

90 g - 3.35 oz



15 cm - 5.9"



3 mm - 0.12"



6 cm - 2.36"



## FX-540 G10OD LINER LOCK

Movimento con cuscinetti a sfera  
Ball bearing operating system

95 g - 3.35 oz



15 cm - 5.9"



3 mm - 0.12"



6 cm - 2.36"



N690Co Top Shield® nero  
Black Top Shield® N690Co  
HRC 58-60



FRN® nero  
Black FRN®



AISI 420 black idroglider  
Black idroglider AISI 420



Alluminio anodizzato nero  
Black anodized aluminium



A filo in AISI 420 black idroglider  
Black idroglider wire clip AISI 420



AISI 303 black idroglider  
Black idroglider AISI 303



N690Co Top Shield® nero  
Black Top Shield® N690Co  
HRC 58-60



FRN® verde OD  
OD green FRN®



AISI 420 black idroglider  
Black idroglider AISI 420



Alluminio anodizzato nero  
Black anodized aluminium



A filo in AISI 420 black idroglider  
Black idroglider wire clip AISI 420



AISI 303 black idroglider  
Black idroglider AISI 303



M390 PVD nero stone washed  
Black PVD stone washed M390  
HRC 59-61



Titanio PVD nero stone washed  
Black PVD stone washed titanium



Titanio PVD nero stone washed  
Black PVD stone washed titanium



Titanio anodizzato bronzo  
Bronze anodized titanium



A filo in AISI 302 PVD nero  
Black PVD wire clip AISI 302



AISI 303 PVD nero  
Black PVD AISI 303



M390 satinato  
Satin M390  
HRC 59-61



Titanio anodizzato blu  
Blue anodized titanium



Titanio anodizzato blu  
Blue anodized titanium



Titanio anodizzato blu  
Blue anodized titanium



A filo in AISI 420 lucido  
Polished wire clip AISI 420



AISI 303 lucido  
Polished AISI 303



M390 satinato  
Satin M390  
HRC 59-61



Micarta naturale  
Natural Micarta



Acciaio inox AISI 420 lucido  
Polished AISI 420 stainless steel



AISI 420 lucido  
Polished AISI 420



A filo in AISI 420 lucido  
Polished wire clip AISI 420



AISI 303 lucido  
Polished AISI 303



M390 satinato  
Satin M390  
HRC 59-61



G10 verde OD  
OD green G10



AISI 420 lucido  
Polished AISI 420



AISI 420 lucido  
Polished AISI 420



A filo in AISI 420 lucido  
Polished wire clip AISI 420



AISI 303 lucido  
Polished AISI 303



**NAUTA**  
**FX-230 ZW**  
SLIP JOINT

**LAMA | BLADE**  
Becut stone washed  
Stone washed Becut  
56-58

**SLIP JOINT**  
AISI 420 satinato  
Satin AISI 420

**MANICO | HANDLE**  
Ziricote  
Ziricote wood

**VITI | SCREWS**  
AISI 303 lucido  
Polished AISI 303

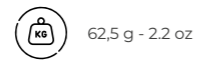
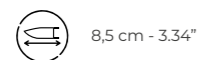

**NAUTA**  
**FX-230 OL**  
SLIP JOINT

**LAMA | BLADE**  
Becut stone washed  
Stone washed Becut  
56-58

**SLIP JOINT**  
AISI 420 satinato  
Satin AISI 420

**MANICO | HANDLE**  
Ulivo  
Olive wood

**VITI | SCREWS**  
AISI 303 lucido  
Polished AISI 303

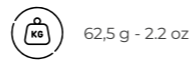
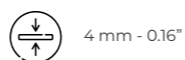

**NAUTA**  
**FX-230 MI**  
SLIP JOINT

**LAMA | BLADE**  
Becut stone washed  
Stone washed Becut  
56-58

**SLIP JOINT**  
AISI 420 satinato  
Satin AISI 420

**MANICO | HANDLE**  
Micarta di iuta nera  
Black jute Micarta

**VITI | SCREWS**  
AISI 303 lucido  
Polished AISI 303

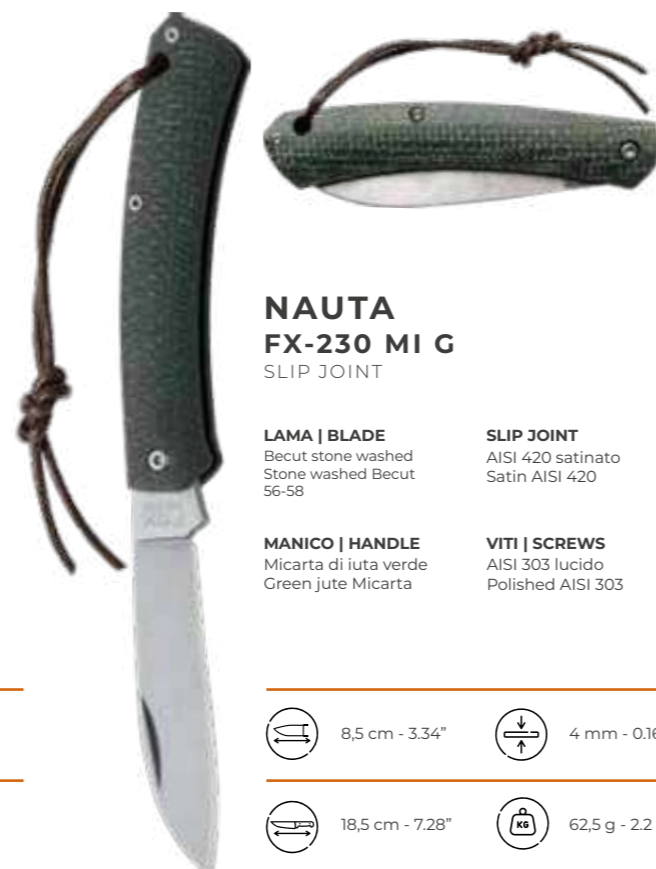
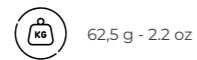
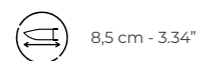

**NAUTA**  
**FX-230 MI G**  
SLIP JOINT

**LAMA | BLADE**  
Becut stone washed  
Stone washed Becut  
56-58

**SLIP JOINT**  
AISI 420 satinato  
Satin AISI 420

**MANICO | HANDLE**  
Micarta di iuta verde  
Green jute Micarta

**VITI | SCREWS**  
AISI 303 lucido  
Polished AISI 303

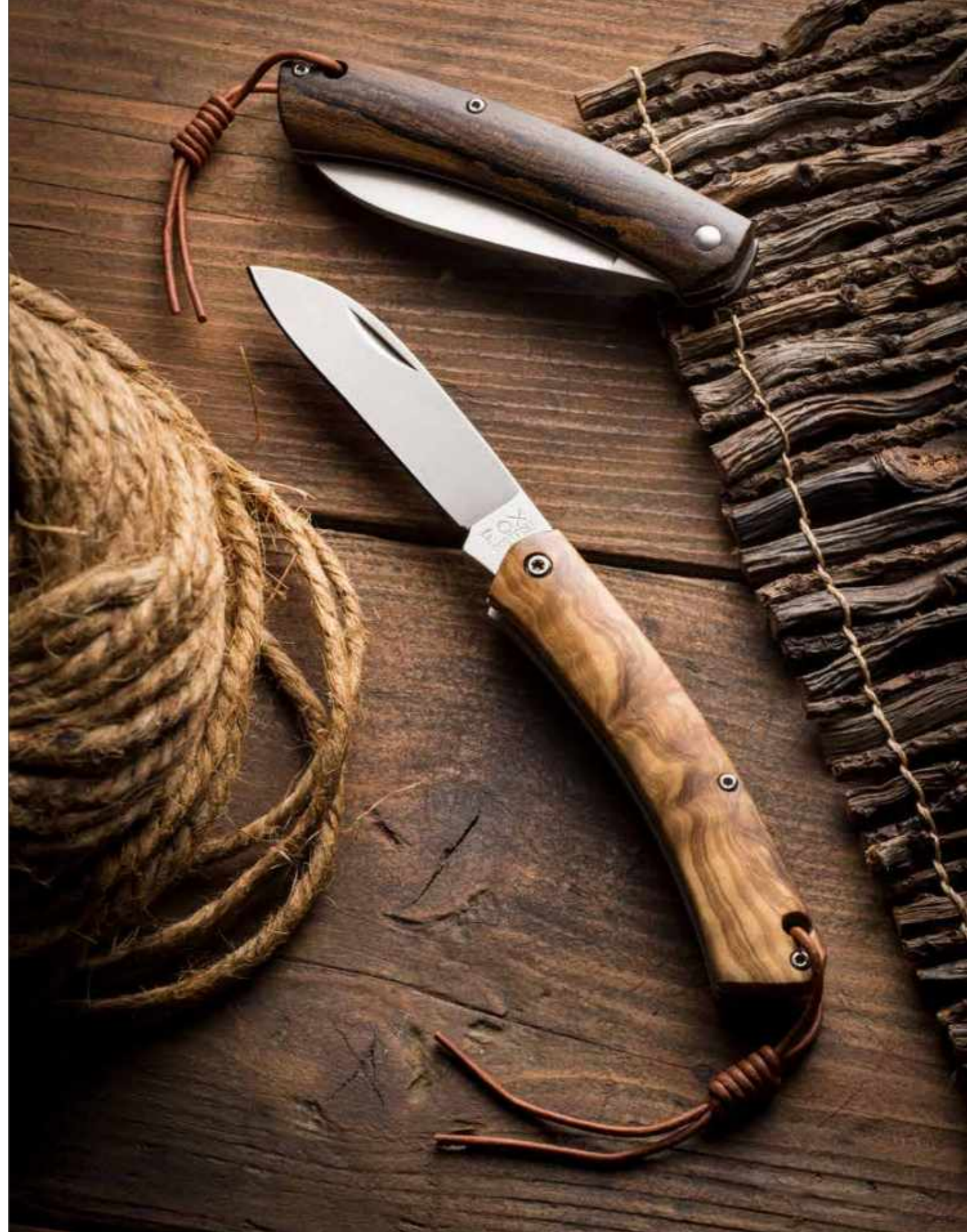
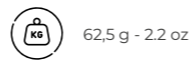
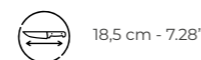
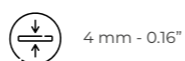



### LIVRI FX-273 CF

SLIP JOINT

**LAMA | BLADE**  
M390 satinato  
Satin M390  
HRC 56-58

**MANICO | HANDLE**  
Fibra di carbonio  
Carbon fiber

**SLIP JOINT**  
AISI 420 satinato  
Satin AISI 420

**VITI | SCREWS**  
AISI 303 lucido  
Polished AISI 303



7 cm - 2.75"



3 mm - 0.12"



15,5 cm - 6.10"



45 g - 1.58 oz



### LIVRI FX-273

SLIP JOINT

**LAMA | BLADE**  
M390 satinato  
Satin M390  
HRC 56-58

**MANICO | HANDLE**  
Micarta verde OD  
OD green Micarta

**SLIP JOINT**  
AISI 420 satinato  
Satin AISI 420

**VITI | SCREWS**  
AISI 303 lucido  
Polished AISI 303



7 cm - 2.75"



3 mm - 0.12"



15,5 cm - 6.10"



45 g - 1.58 oz



### LIVRI FX-273 ZW

SLIP JOINT

**LAMA | BLADE**  
M390 satinato  
Satin M390  
HRC 56-58

**MANICO | HANDLE**  
Ziricote  
Ziricote wood

**SLIP JOINT**  
AISI 420 satinato  
Satin AISI 420

**VITI | SCREWS**  
AISI 303 lucido  
Polished AISI 303



7 cm - 2.75"



3 mm - 0.12"



15,5 cm - 6.10"



45 g - 1.58 oz



### LIVRI FX-273 MI

SLIP JOINT

**LAMA | BLADE**  
M390 satinato  
Satin M390  
HRC 56-58

**MANICO | HANDLE**  
Micarta di iuta naturale  
Natural yute Micarta

**SLIP JOINT**  
AISI 420 satinato  
Satin AISI 420

**VITI | SCREWS**  
AISI 303 lucido  
Polished AISI 303



7 cm - 2.75"



3 mm - 0.12"



15,5 cm - 6.10"



45 g - 1.58 oz



### LIBAR FX-582 CF

SLIP JOINT

**LAMA | BLADE**  
M390 satinato  
Satin M390  
HRC 56-58

**MANICO | HANDLE**  
Fibra di carbonio  
Carbon fiber

**SLIP JOINT**  
AISI 420 satinato  
Satin AISI 420

**VITI | SCREWS**  
AISI 303 lucido  
Polished AISI 303



7 cm - 2.75"



3 mm - 0.12"



15,5 cm - 6.10"



45 g - 1.58 oz



### LIBAR FX-582

SLIP JOINT

**LAMA | BLADE**  
M390 satinato  
Satin M390  
HRC 56-58

**MANICO | HANDLE**  
Micarta verde OD  
OD green Micarta

**SLIP JOINT**  
AISI 420 satinato  
Satin AISI 420

**VITI | SCREWS**  
AISI 303 lucido  
Polished AISI 303



7 cm - 2.75"



3 mm - 0.12"



15,5 cm - 6.10"



45 g - 1.58 oz



### LIBAR FX-582 OL

SLIP JOINT

**LAMA | BLADE**  
M390 satinato  
Satin M390  
HRC 56-58

**MANICO | HANDLE**  
Ulivo  
Olive wood

**SLIP JOINT**  
AISI 420 satinato  
Satin AISI 420

**VITI | SCREWS**  
AISI 303 lucido  
Polished AISI 303



7 cm - 2.75"



3 mm - 0.12"



15,5 cm - 6.10"



45 g - 1.58 oz



### LIBAR FX-582 MI

SLIP JOINT

**LAMA | BLADE**  
M390 satinato  
Satin M390  
HRC 56-58

**MANICO | HANDLE**  
Micarta di iuta naturale  
Natural yute Micarta

**SLIP JOINT**  
AISI 420 satinato  
Satin AISI 420

**VITI | SCREWS**  
AISI 303 lucido  
Polished AISI 303



7 cm - 2.75"



3 mm - 0.12"



15,5 cm - 6.10"



45 g - 1.58 oz

# FX-558

## GUNSTOCK



### FX-558 OL

#### SLIP JOINT

NEW ITEM



7 cm - 2.75"



3 mm - 0.12"



16 cm - 6.30"



62 g - 2.18 oz

**LAMA | BLADE**  
M390 satinato  
Satin M390  
HRC 59-61

**DISTANZIALE | SPACER**  
AISI 420 lucido  
Polished AISI 420

**MANICO | HANDLE**  
Ulivo + titanio  
Olive wood + titanium

**VITI | SCREWS**  
AISI 303 lucido  
Polished AISI 303



Cuoio nero  
Black leather



**SLIP JOINT**  
AISI 420 lucido  
Polished AISI 420



### FX-558 BI

#### SLIP JOINT

NEW ITEM



Cuoio nero  
Black leather

**LAMA | BLADE**  
M390 satinato  
Satin M390  
HRC 59-61

**DISTANZIALE | SPACER**  
AISI 420 lucido  
Polished AISI 420

**MANICO | HANDLE**  
Micarta Bison + titanio  
Bison Micarta + titanium

**VITI | SCREWS**  
AISI 303 lucido  
Polished AISI 303

**SLIP JOINT**  
AISI 420 lucido  
Polished AISI 420



7 cm - 2.75"



3 mm - 0.12"



16 cm - 6.30"



62 g - 2.18 oz



### FX-558 BO

#### SLIP JOINT

NEW ITEM



Cuoio nero  
Black leather

**LAMA | BLADE**  
M390 satinato  
Satin M390  
HRC 59-61

**DISTANZIALE | SPACER**  
AISI 420 lucido  
Polished AISI 420

**MANICO | HANDLE**  
G10 avorio + titanio  
Ivory G10 + titanium

**VITI | SCREWS**  
AISI 303 lucido  
Polished AISI 303

**SLIP JOINT**  
AISI 420 lucido  
Polished AISI 420



7 cm - 2.75"



3 mm - 0.12"



16 cm - 6.30"



62 g - 2.18 oz



# FX-130 PRO HUNTER

Il Fox Pro Hunter chiudibile presenta un innovativo sistema di blocco L.A.W.K.S.®, progettato non solo per prevenire la chiusura accidentale della lama, ma anche per trasformare efficacemente il coltello in una solida lama fissa. Il suo manico fresato in 3D offre un'impugnatura eccezionale in tutte le posizioni, garantendo una presa sicura anche nelle situazioni più impegnative. Il Pro Hunter è un compagno affidabile che non ti abbandonerà mai, soprattutto quando ti troverai ad affrontare sentieri meno battuti.

The closable Fox Pro Hunter features an innovative L.A.W.K.S.® locking system, designed not only to prevent accidental blade closure, but also to effectively transform the knife into a solid fixed blade. Its 3D-milled handle provides exceptional grip in all positions, ensuring a secure hold in even the most demanding situations. The Pro Hunter is a reliable companion that will never let you down, especially when you find yourself tackling less traveled trails.



Doppio assetto (coltello portatile anche come lama fissa)

Dual purpose (knife can be carried as a fixed blade)



Cuio nero  
Black leather



Cuio marrone  
Brown leather

## FX-130 MBSW LINER LOCK



200 g - 7.05 oz

21,5 cm - 8.46"

5 mm - 0.20"

9,5 cm - 3.74"

N690Co stone washed  
Stone washed N690Co  
HRC 58-60

Micarta nera  
Black Micarta

AISI 420 sabbiato  
Sandblasted AISI 420

Alluminio anodizzato nero  
Black anodized aluminium

AISI 303 sabbiato  
Sandblasted AISI 303

## FX-130 DW LINER LOCK



200 g - 7.05 oz

21,5 cm - 8.46"

5 mm - 0.20"

9,5 cm - 3.74"

N690Co satinato  
Satin N690Co  
HRC 58-60

Santos  
Santos wood

AISI 420 lucido  
Polished AISI 420

Alluminio anodizzato nero  
Black anodized aluminium

AISI 303 lucido  
Polished AISI 303



Nylon®

## EL CAPITAN

designed by Tommaso Rumici

### SK-02 BSW

FRAME LOCK

**LAMA | BLADE**  
D2 PVD nero stone washed  
Black PVD stone washed D2  
HRC 59-61

**MANICO | HANDLE**  
G10 nero  
Black G10

**FRAME LOCK**  
Alluminio anodizzato nero  
Black anodized aluminium

**DISTANZIALE | SPACER**  
Alluminio anodizzato nero  
Black anodized aluminium

**CLIP**  
Sagomata in AISI 420  
sabbiato  
Sandblasted shaped  
AISI 420

**VITI | SCREWS**  
AISI 303 sabbiato  
Sandblasted AISI 303

10 cm - 3.94"

4 mm - 0.16"

22,5 cm - 8.86"

182 g - 6.42 oz



Nylon®

## EL CAPITAN

designed by Tommaso Rumici

### SK-02 OD

FRAME LOCK

**LAMA | BLADE**  
M390 satinato  
Satin M390  
HRC 59-61

**MANICO | HANDLE**  
Alluminio anodizzato  
verde OD  
OD green anodized  
aluminium

**FRAME LOCK**  
Alluminio anodizzato  
verde OD  
OD green anodized  
aluminium

**DISTANZIALE | SPACER**  
Alluminio anodizzato  
verde OD  
OD green anodized  
aluminium

**CLIP**  
Sagomata in AISI 420  
black idrogliider  
Black idrogliider shaped  
AISI 420

**VITI | SCREWS**  
AISI 303 black idrogliider  
Black idrogliider AISI 303

10 cm - 3.94"

4 mm - 0.16"

22,5 cm - 8.86"

176 g - 6.21 oz



Nylon®

## EL CAPITAN

designed by Tommaso Rumici

### SK-02 PVD

FRAME LOCK

**LAMA | BLADE**  
D2 PVD nero  
Black PVD D2  
HRC 59-61

**MANICO | HANDLE**  
Micarta verde OD  
OD green Micarta

**FRAME LOCK**  
Alluminio anodizzato  
grigio  
Grey anodized aluminium

10 cm - 3.94"

4 mm - 0.16"

22,5 cm - 8.86"

182 g - 6.42 oz



Cuio nero  
Black leather

## TUR

designed by Vox

### FX-528 B

LINER LOCK

**LAMA | BLADE**  
Elmax PVD nero  
Black PVD Elmax  
HRC 58-60

**MANICO | HANDLE**  
Fibra di carbonio  
Carbon fiber

**LINER LOCK**  
AISI 420 black idrogliider  
Black idrogliider AISI 420

7,5 cm - 2.95"

3,5 mm - 0.14"

18 cm - 7.8"

95 g - 3.35 oz

**DISTANZIALE | SPACER**  
Titanio anodizzato blu  
Blue anodized titanium

**CLIP**  
Sagomata in titanio  
anodizzato blu  
Blue anodized shaped  
titanium

**VITI | SCREWS**  
AISI 303 rivestito al nichel  
Nickel plated AISI 303



## KARAMBIT

Fox Knives offre un'ampia scelta di karambit chiudibili, fissi e da training progettati da noti insegnanti di arti marziali assieme al Fox Knives Team e realizzati con materiali di prima qualità. I karambit, di origini asiatiche, vengono utilizzati soprattutto come arma da difesa e si contraddistinguono grazie alla tipica lama a forma di mezzaluna e all'anello alla base dell'impugnatura.

Fox Knives offers a wide selection of folding, fixed, and training karambits designed by well-known martial arts teachers together with the Fox Knives Team and made from premium materials. Karambits, of Asian origin, are used primarily as a defensive weapon and are distinguished by the typical crescent shaped blade and ring at the base of the handle.

# FX-599 ALB

## KARAMBIT

**FX-599 ALB-1**  
LINER LOCK  
▼  
Movimento con cuscinetti a sfera  
Ball bearing operating system

NEW ITEM

100 g - 3.5 oz



17,5 cm - 6.89"



3 mm - 0.12"



6,5 cm - 2.56"





 N690Co black idroglider  
Black idroglider N690Co  
HRC 58-60

 Alluminio anodizzato nero  
Black anodized aluminium

 AISI 420 black idroglider  
Black idroglider AISI 420

 Alluminio anodizzato nero  
Black anodized aluminium

 Sagomata in AISI 420 black idroglider  
Black idroglider shaped AISI 420

 AISI 303 black idroglider  
Black idroglider AISI 303



**FX-599 ALB-2**  
LINER LOCK

NEW ITEM



**FX-599 ALB-3**  
LINER LOCK

NEW ITEM



**FX-599 ALB-4**  
LINER LOCK

NEW ITEM



**FX-599 ALB-5**  
LINER LOCK

NEW ITEM



# FX-599 KARAMBIT



## FX-599TiC FRAME LOCK



### LAMA | BLADE

Elmax Top Shield® nero  
Black Top Shield® Elmax  
HRC 59-61

### MANICO | HANDLE

Fibra di carbonio 3K  
3K carbon fiber

### FRAME LOCK

Titanio anodizzato bronzo  
Bronze anodized titanium

▼  
Movimento con cuscinetti a sfera  
Ball bearing operating system

### ANELLO | RING

Titanio anodizzato bronzo  
Bronze anodized titanium

### CLIP

Sagomata in titanio anodizzato bronzo  
Bronze anodized shaped titanium

### VITI | SCREWS

AISI 303 black idroglider  
Black idroglider AISI 303



Cuoio nero  
Black leather



## FX-599TiCS FRAME LOCK

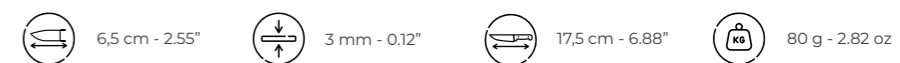

### LAMA | BLADE

Elmax sabbbiato  
Sandblasted Elmax  
HRC 59-61

### MANICO | HANDLE

Fibra di carbonio 3K  
3K carbon fiber

### FRAME LOCK

Titanio sabbbiato  
Sandblasted titanium

▼  
Movimento con cuscinetti a sfera  
Ball bearing operating system

### ANELLO | RING

Titanio sabbbiato  
Sandblasted titanium

### CLIP

Sagomata in titanio sabbbiato  
Sandblasted shaped titanium

### VITI | SCREWS

Titanio sabbbiato  
Sandblasted titanium



Cuoio nero  
Black leather





## FX-599

LINER LOCK



### LAMA | BLADE

N690Co black idroglider  
Black idroglider N690Co  
HRC 58-60

### MANICO | HANDLE

G10 nero  
Black G10

### LINER LOCK

Black idroglider AISI 420  
AISI 420 black idroglider

Movimento con cuscinetti a sfera  
Ball bearing operating system

### ANELLO | RING

Alluminio anodizzato nero  
Black anodized aluminium

### CLIP

Sagomata in AISI 420 black idroglider  
Black idroglider shaped AISI 420

### VITI | SCREWS

AISI 303 rivestito al nichel  
Nickel plated AISI 303



## FX-599 TK

LINER LOCK



### LAMA | BLADE

AISI 420 sabbato  
Sandblasted AISI 420  
HRC 54-56

### MANICO | HANDLE

G10 arancione  
Orange G10

### LINER LOCK

AISI 420 lucido  
Polished AISI 420

Movimento con cuscinetti a sfera  
Ball bearing operating system

### ANELLO | RING

Alluminio anodizzato nero  
Black anodized aluminium

### CLIP

Sagomata in AISI 420 black idroglider  
Black idroglider shaped AISI 420

### VITI | SCREWS

AISI 303 rivestito al nichel  
Nickel plated AISI 303



110 g - 3.88 oz



## FX-599 RS

LINER LOCK

Movimento con cuscinetti a sfera  
Ball bearing operating system

17,5 cm - 6.88"



3 mm - 0.12"



6,5 cm - 2.55"



Con blocco di sicurezza L.A.W.K.S.  
With L.A.W.K.S.® safety lock



N690Co black idroglider  
Black idroglider N690Co  
HRC 58-60



G10 nero  
Black G10



AISI 420 black idroglider  
Black idroglider AISI 420



Alluminio anodizzato nero  
Black anodized aluminium



Sagomata in AISI 420 black idroglider  
Black idroglider shaped AISI 420



AISI 303 rivestito al nichel  
Nickel plated AISI 303

110 g - 3.88 oz



## FX-599 RSY

LINER LOCK

Movimento con cuscinetti a sfera  
Ball bearing operating system

17,5 cm - 6.88"



3 mm - 0.12"



6,5 cm - 2.55"



Con blocco di sicurezza L.A.W.K.S.  
With L.A.W.K.S.® safety lock



N690Co stone washed  
Stone washed N690Co  
HRC 58-60



G10 giallo fosforescente  
Glow in the dark yellow G10



AISI 420 lucido  
Polished AISI 420



Alluminio anodizzato rosso  
Red anodized aluminium



Sagomata in AISI 420 lucido  
Polished shaped AISI 420



AISI 303 lucido  
Polished AISI 303



**FX-599 XT**  
BACK LOCK

- 6,5 cm - 2.55"
- 3 mm - 0.12"
- 17,5 cm - 6.88"
- 100 g - 3.52 oz

**LAMA | BLADE**

N690Co black idrogliider  
Black idrogliider N690Co  
HRC 58-60

**MANICO | HANDLE**

G10 nero  
Black G10

**BACK LOCK**

AISI 420 black idrogliider  
Black idrogliider AISI 420

▼  
Movimento con cuscinetti a sfera  
Ball bearing operating system

**ANELLO | RING**

Alluminio anodizzato nero  
Black anodized aluminium

**CLIP**

Sagomata in AISI 420 black idrogliider  
Black idrogliider shaped AISI 420

**VITI | SCREWS**

AISI 303 rivestito al nichel  
Nickel plated AISI 303

Con blocco di sicurezza L.A.W.K.S.  
With L.A.W.K.S.® safety lock

Frangivetro in Tungsteno  
Tungsten glass breaker



**FX-599 XTS** Con blocco di sicurezza L.A.W.K.S.  
BACK LOCK With L.A.W.K.S.® safety lock

▼  
Movimento con cuscinetti a sfera  
Ball bearing operating system

**LAMA | BLADE**

N690Co black idrogliider  
Black idrogliider N690Co  
HRC 58-60

**MANICO | HANDLE**

G10 nero  
Black G10

**BACK LOCK**

AISI 420 black idrogliider  
Black idrogliider AISI 420

Frangivetro in Tungsteno  
Tungsten glass breaker

- 6,5 cm - 2.55"
- 3 mm - 0.12"

- 17,5 cm - 6.88"
- 100 g - 3.52 oz

**ANELLO | RING**

Alluminio anodizzato nero  
Black anodized aluminium

**CLIP**

Sagomata in AISI 420 black idrogliider  
Black idrogliider shaped AISI 420

**VITI | SCREWS**

AISI 303 rivestito al nichel  
Nickel plated AISI 303

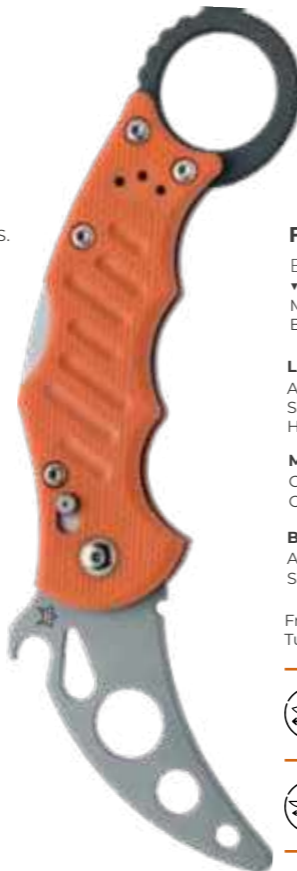

**FX-599 XTTC** Con blocco di sicurezza L.A.W.K.S.  
BACK LOCK With L.A.W.K.S.® safety lock

▼  
Movimento con cuscinetti a sfera  
Ball bearing operating system

**LAMA | BLADE**

AISI 420 sabbciato  
Sandblasted AISI 420  
HRC 54-56

**MANICO | HANDLE**

G10 arancione  
Orange G10

**BACK LOCK**

AISI 420 sabbciato  
Sandblasted AISI 420

Frangivetro in Tungsteno  
Tungsten glass breaker

- 6,5 cm - 2.55"
- 3 mm - 0.12"

- 17,5 cm - 6.88"
- 110 g - 3.88 oz

**ANELLO | RING**

Alluminio anodizzato nero  
Black anodized aluminium

**CLIP**

Sagomata in AISI 420 sabbciato  
Sandblasted shaped AISI 420

**VITI | SCREWS**

AISI 303 lucido  
Polished AISI 303



**478**  
LINER LOCK



- 130 g - 4.58 oz
- 19 cm - 7.48"
- 3 mm - 0.12"
- 7,5 cm - 2.95"

- N690Co sabbciato  
Sandblasted N690Co  
HRC 58-60
- Alluminio anodizzato grigio  
Grey anodized aluminium
- AISI 420 lucido  
Polished AISI 420
- Alluminio anodizzato nero  
Black anodized aluminium
- Sagomata in AISI 420 black idrogliider  
Black idrogliider shaped AISI 420
- AISI 303 rivestito al nichel  
Nickel plated AISI 303



**479**  
LINER LOCK



- 130 g - 4.58 oz
- 19 cm - 7.48"
- 3 mm - 0.12"
- 7,5 cm - 2.95"

- N690Co black idrogliider  
Black idrogliider N690Co  
HRC 58-60
- G10 nero  
Black G10
- AISI 420 black idrogliider  
Black idrogliider AISI 420
- Alluminio anodizzato nero  
Black anodized aluminium
- Sagomata in AISI 420 black idrogliider  
Black idrogliider shaped AISI 420
- AISI 303 rivestito al nichel  
Nickel plated AISI 303



**479 TK**  
LINER LOCK



- 130 g - 4.58 oz
- 19 cm - 7.48"
- 3 mm - 0.12"
- 7,5 cm - 2.95"

- AISI 420 sabbciato  
Sandblasted AISI 420  
HRC 54-56
- G10 rosso  
Red G10
- AISI 420 black idrogliider  
Black idrogliider AISI 420
- Alluminio anodizzato nero  
Black anodized aluminium
- Sagomata in AISI 420 black idrogliider  
Black idrogliider shaped AISI 420
- AISI 303 rivestito al nichel  
Nickel plated AISI 303 el

# FX-535 MINI-KA



## LINER LOCK

**LAMA | BLADE**  
1.4116 sabbiato  
Sandblasted 1.4116  
HRC 55-57

**KARAMBIT RING**  
AISI 420 sabbiato  
Sandblasted AISI 420

**MANICO | HANDLE**  
FRN® colorato  
Colored FRN®

**CLIP**  
Sagomata in AISI 420  
sabbiato  
Sandblasted shaped  
AISI 420

**LINER LOCK**  
AISI 420 sabbiato  
Sandblasted AISI 420

**VITI | SCREWS**  
AISI 303 lucido  
Polished AISI 303

2,5 cm - 0.98" 2,5 mm - 0.10"

8 cm - 3.14" 30 gr - 1.06 oz



Portachiavi  
Keychain



FX-535 FX-535 BL FX-535 R FX-535 O

## LINER LOCK

**LAMA | BLADE**  
1.4116 black idrogliider  
Black idrogliider 1.4116  
HRC 55-57

**KARAMBIT RING**  
AISI 420 black idrogliider  
Black idrogliider AISI 420

**MANICO | HANDLE**  
FRN® colorato  
Colored FRN®

**CLIP**  
Sagomata in AISI 420 black  
idrogliider  
Black idrogliider shaped  
AISI 420

**LINER LOCK**  
AISI 420 balck idrogliider  
Black idrogliider AISI 420

**VITI | SCREWS**  
AISI 303 balck idrogliider  
Black idrogliider AISI 303

2,5 cm - 0.98" 2,5 mm - 0.10"

8 cm - 3.14" 30 gr - 1.06 oz



Portachiavi  
Keychain



FX-535 B FX-535 BLB FX-535 RB FX-535 OB

# FX-536 MINI-TA



## LINER LOCK

**LAMA | BLADE**  
1.4116 sabbiato  
Sandblasted 1.4116  
HRC 55-57

**KARAMBIT RING**  
AISI 420 sabbiato  
Sandblasted AISI 420

**MANICO | HANDLE**  
FRN® colorato  
Colored FRN®

**CLIP**  
Sagomata in AISI 420  
sabbiato  
Sandblasted shaped  
AISI 420

**LINER LOCK**  
AISI 420 sabbiato  
Sandblasted AISI 420

**VITI | SCREWS**  
AISI 303 lucido  
Polished AISI 303

2,5 cm - 0.98" 2,5 mm - 0.10"

8 cm - 3.14" 30 gr - 1.06 oz



Portachiavi  
Keychain



FX-536 FX-536 OD FX-536 CB



## LINER LOCK

**LAMA | BLADE**  
1.4116 black idrogliider  
Black idrogliider 1.4116  
HRC 55-57

**KARAMBIT RING**  
AISI 420 black idrogliider  
Black idrogliider AISI 420

**MANICO | HANDLE**  
FRN® colorato  
Colored FRN®

**CLIP**  
Sagomata in AISI 420 black  
idrogliider  
Black idrogliider shaped  
AISI 420

**LINER LOCK**  
AISI 420 balck idrogliider  
Black idrogliider AISI 420

**VITI | SCREWS**  
AISI 303 balck idrogliider  
Black idrogliider AISI 303

2,5 cm - 0.98" 2,5 mm - 0.10"

8 cm - 3.14" 30 gr - 1.06 oz



Portachiavi  
Keychain

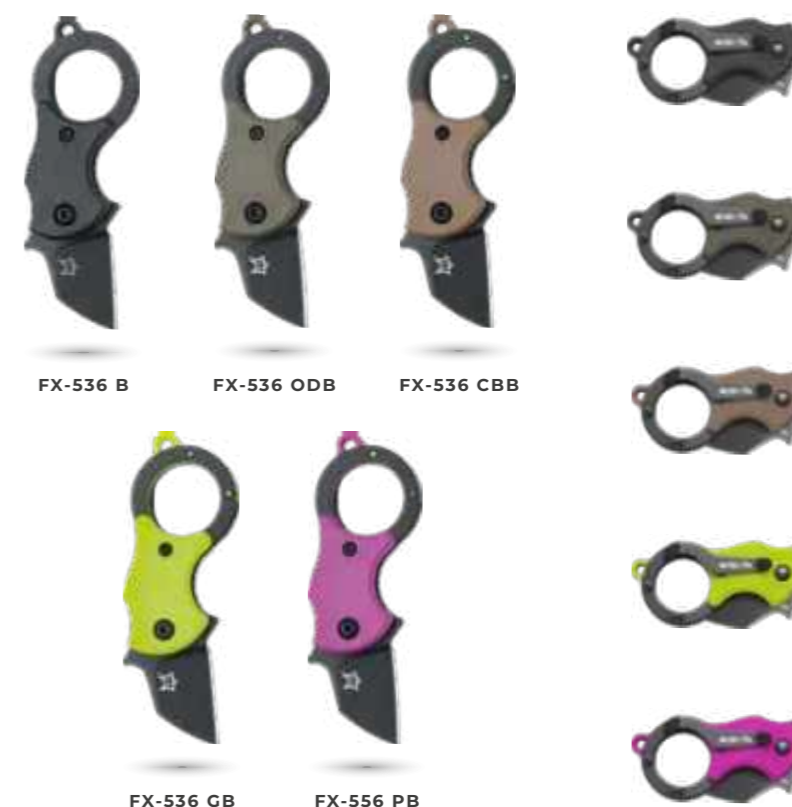

FX-536 B FX-536 ODB FX-536 CBB

FX-536 GB FX-536 PB

**PIKAL**

designed by giuliano Ron

**FX-826**  
LINER LOCK

113 g - 3,99 oz



18,2 cm - 7,17"



3 mm - 0,12"



6 cm - 2,36"



- N690Co black idrogli-der Black idrogli-der N690Co HRC 58-60
- G10 nero Black G10
- AISI 420 black idrogli-der Black idrogli-der AISI 420
- Alluminio anodizzato nero Black anodized aluminium
- Sagomata in AISI 420 black idrogli-der Black idrogli-der shaped AISI 420
- AISI 303 black idrogli-der Black idrogli-der AISI 303

**CHIROPTERA**

designed by Richard Derespina

**FX-590**  
LINER LOCK

110 g - 3,88 oz



15,5 cm - 6,10"



3 mm - 0,12"



6,5 cm - 2,55"



- N690Co Top Shield® nero Black Top Shield® N690Co HRC 58-60
- G10 nero Black G10
- AISI 420 black idrogli-der Black idrogli-der AISI 420
- Alluminio anodizzato nero Black anodized aluminium
- Sagomata in AISI 420 black idrogli-der Black idrogli-der shaped AISI 420
- AISI 303 rivestito al nichel Nickel plated AISI 303



**KEA**

designed by Jared Wihongi

**FX-650**  
LINER LOCK

**LAMA | BLADE**  
N690Co black idrogli-der stone washed Black idrogli-der stone washed N690Co HRC 58-60

**MANICO | HANDLE**  
G10 nero Black G10

**LINER LOCK**  
AISI 420 black idrogli-der Black idrogli-der AISI 420

**DISTANZIALE | SPACER**  
G10 nero Black G10

**CLIP**  
A filo in AISI 420 black idrogli-der Black idrogli-der wire clip AISI 420

**VITI | SCREWS**  
AISI 303 black idrogli-der Black idrogli-der AISI 303

7,3 cm - 2,95"

4 mm - 0,16"

16 cm - 6,30"

90 g - 3,17 oz



Nylon®



**TOA**

designed by Jared Wihongi

**FX-652**  
FIXED BLADE

**LAMA | BLADE**  
N690Co black idrogli-der stone washed Black idrogli-der stone washed N690Co HRC 58-60

**MANICO | HANDLE**  
G10 nero Black G10

**VITI | SCREWS**  
AISI 303 black idrogli-der Black idrogli-der AISI 303

7,5 cm - 2,95"

4 mm - 0,16"

18 cm - 7,09"

130 g - 4,59 oz



**MOA**

designed by Jared Wihongi

**FX-651**  
FIXED BLADE

**LAMA | BLADE**  
N690Co black idrogli-der stone washed Black idrogli-der stone washed N690Co HRC 58-60

**MANICO | HANDLE**  
G10 nero Black G10

**VITI | SCREWS**  
AISI 303 black idrogli-der Black idrogli-der AISI 303

7,5 cm - 2,95"

4 mm - 0,16"

18 cm - 7,09"

130 g - 4,59 oz



Fodero in Kydex con clip Tek lock Kydex sheath with Tek lock clip

**MOA**

designed by Jared Wihongi

**FX-653**  
LINER LOCK

**LAMA | BLADE**  
N690Co black idrogli-der stone washed Black idrogli-der stone washed N690Co HRC 58-60

**MANICO | HANDLE**  
G10 nero Black G10

**LINER LOCK**  
AISI 420 black idrogli-der Black idrogli-der AISI 420

7 cm - 2,76"

4 mm - 0,16"

19 cm - 7,48"

120 g - 4,23 oz



Nylon®

# FX-803 TRIBAL K

designed by Doug Marcaida



## FX-803 TiPVD FIXED BLADE

 7,7 cm - 3"
  3 mm - 0.12"
  14,8 cm - 5.82"
  128,5 g - 4.53 oz

**LAMA | BLADE**  
M390 PVD nero  
Black PVD M390  
HRC 59-61

**MANICO | HANDLE**  
Titanio anodizzato bronzo  
Bronze anodized titanium

**VITI | SCREWS**  
AISI 303 PVD nero  
Black PVD AISI 303



Kydex con Ulticlip  
Kydex sheath with Ulticlip







## FX-803 FIXED BLADE

**LAMA | BLADE**  
N690Co Top Shield® nero  
Black Top Shield® N690Co  
HRC 58-60

**MANICO | HANDLE**  
G10 nero  
Black G10

**VITI | SCREWS**  
AISI 303 black idrogliider  
Black idrogliider AISI 303

Kydex con Ulticlip  
Kydex sheath with  
Ulticlip

 7,7 cm - 3"
  3 mm - 0.12"
  14,8 cm - 5.82"
  97,5 g - 3.45 oz

Il design Tribal K trae ispirazione da un Karambit disegnato da Daniel Mumbakki Foronda, amico di Marcaida e collega filippino artista marziale. Mumbakki, orgoglioso della sua eredità Igorot, appartiene a un popolo indigeno delle montagne della Cordigliera nelle Filippine settentrionali. Il termine Igorots deriva dalla parola spagnola "Ygollotes", che significa "gente di montagna". Molte persone Igorot indossano collane realizzate con denti di cinghiale, e la forma di tali denti ha ispirato il modello per il design Tribal K. I bordi seghettati sul dorso del Tribal K possono essere utilizzati per eseguire tagli simili a quelli di una sega, mentre il design del manico omaggia motivi triangolari e linee di movimento presenti in numerosi sistemi di arti marziali filippini.

The Tribal K design draws inspiration from a Karambit designed by Daniel Mumbakki Foronda, Marcaida's friend and fellow Filipino martial artist. Mumbakki, proud of his Igorot heritage, belongs to an indigenous people of the Cordillera Mountains in the northern Philippines. The term Igorots comes from the Spanish word "Ygollotes," meaning "mountain people." Many Igorot people wear necklaces made from boar teeth, and the shape of those teeth inspired the pattern for the Tribal K design. The serrated edges on the back of the Tribal K can be used to make saw-like cuts, while the handle design pays homage to triangular patterns and lines of motion found in many Filipino martial arts systems.



## FX-802 TiPVD

### LINER LOCK



#### LAMA | BLADE

M390 PVD nero  
Black PVD M390  
HRC 59-61

#### ANELLO | RING

Alluminio anodizzato nero  
Black anodized aluminium

#### CLIP

Sagomata in AISI 420 PVD nero  
Black PVD shaped AISI 420

#### MANICO | HANDLE

Titanio anodizzato bronzo  
Bronze anodized titanium

#### LINER LOCK

AISI 420 PVD nero  
Black PVD AISI 420

#### VITI | SCREWS

AISI 303 PVD nero  
Black PVD AISI 303



Packaging per il modello  
FX-802 TiPVD + fodero in Nylon®  
Packaging for FX-802 TiPVD model  
+ Nylon® sheath



## FX-802

### LINER LOCK

#### LAMA | BLADE

N690Co Top Shield® nero  
Black Top Shield® N690Co  
HRC 58-60

#### MANICO | HANDLE

G10 nero  
Black G10

#### LINER LOCK

AISI 420 black idrogliider  
Black idrogliider AISI 420

#### ANELLO | RING

Alluminio anodizzato nero  
Black anodized aluminium

#### CLIP

Sagomata in AISI 420  
black idrogliider  
Black idrogliider shaped  
AISI 420

#### VITI | SCREWS

AISI 303 black idrogliider  
Black idrogliider AISI 303



## FX-802 TK

### LINER LOCK

#### LAMA | BLADE

N690Co sabbaiato  
Sandblasted N690Co  
HRC 58-60

#### MANICO | HANDLE

G10 arancione  
Orange G10

#### LINER LOCK

AISI 420 black idrogliider  
Black idrogliider AISI 420

#### ANELLO | RING

Alluminio anodizzato nero  
Black anodized aluminium

#### CLIP

Sagomata in AISI 420  
black idrogliider  
Black idrogliider shaped  
AISI 420

#### VITI | SCREWS

AISI 303 black idrogliider  
Black idrogliider AISI 303



## FX-597

### THE DART

designed by Doug Marcaida



## FX-597

### LINER LOCK

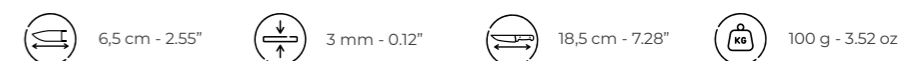

#### LAMA | BLADE

N690Co black idrogliider  
Black idrogliider N690Co  
HRC 58-60

#### MANICO | HANDLE

G10 nero  
Black G10

#### LINER LOCK

AISI 420 black idrogliider  
Black idrogliider AISI 420

▼ Movimento con cuscinetti a sfera  
Ball bearing operating system

#### ANELLO | RING

Alluminio anodizzato nero  
Black anodized aluminium

#### CLIP

Sagomata in AISI 420 black idrogliider  
Black idrogliider shaped AISI 420

#### VITI | SCREWS

AISI 303 rivestito al nichel  
Nickel plated AISI 303



## FX-597 OD

### LINER LOCK



#### LAMA | BLADE

N690Co black idrogliider  
Black idrogliider N690Co  
HRC 58-60

#### MANICO | HANDLE

G10 verde OD  
OD green G10

#### LINER LOCK

AISI 420 black idrogliider  
Black idrogliider AISI 420

▼ Movimento con cuscinetti a sfera  
Ball bearing operating system

#### ANELLO | RING

Alluminio anodizzato nero  
Black anodized aluminium

#### CLIP

Sagomata in AISI 420 black idrogliider  
Black idrogliider shaped AISI 420

#### VITI | SCREWS

AISI 303 rivestito al nichel  
Nickel plated AISI 303





### FX-597 XT

LINER LOCK

Con blocco di sicurezza L.A.W.K.S.  
With L.A.W.K.S.® safety lock

▼ Movimento con cuscinetti a sfera  
Ball bearing operating system

#### LAMA | BLADE

N690Co black idrogliker  
Black idrogliker N690Co  
HRC 58-60

#### MANICO | HANDLE

G10 nero  
Black G10

#### LINER LOCK

AISI 420 black idrogliker  
Black idrogliker AISI 420

Frangivetro in Tungsteno  
Tungsten glass breaker

#### ANELLO | RING

Alluminio anodizzato nero  
Black anodized aluminium

#### CLIP

Sagomata in AISI 420  
black idrogliker  
Black idrogliker shaped  
AISI 420

#### VITI | SCREWS

AISI 303 rivestito al nichel  
Nickel plated AISI 303



6,5 cm - 2.55"



3 mm - 0.12"



18,5 cm - 7.28"



100 g - 3.52 oz

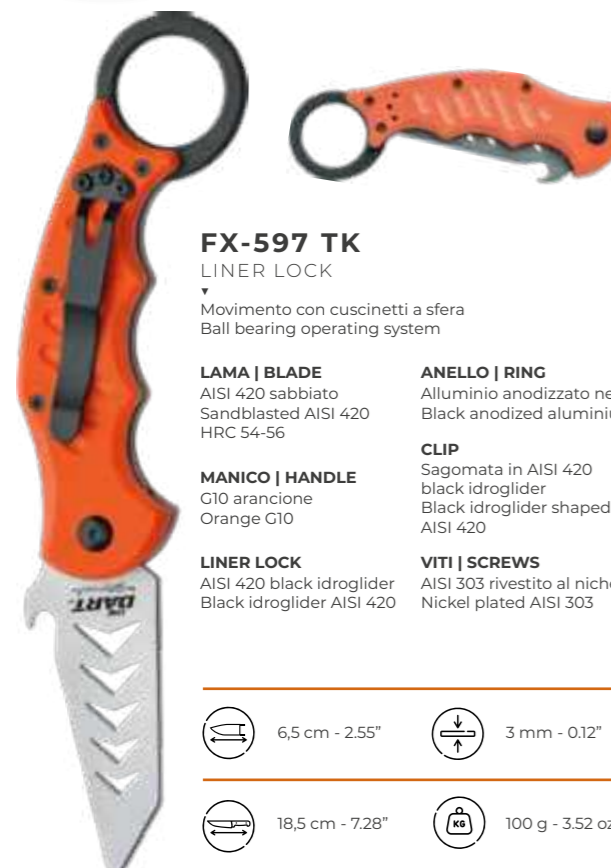

### FX-597 TK

LINER LOCK

▼ Movimento con cuscinetti a sfera  
Ball bearing operating system

#### LAMA | BLADE

AISI 420 sabbiato  
Sandblasted AISI 420  
HRC 54-56

#### MANICO | HANDLE

G10 arancione  
Orange G10

#### LINER LOCK

AISI 420 black idrogliker  
Black idrogliker AISI 420

#### ANELLO | RING

Alluminio anodizzato nero  
Black anodized aluminium

#### CLIP

Sagomata in AISI 420  
black idrogliker  
Black idrogliker shaped  
AISI 420

#### VITI | SCREWS

AISI 303 rivestito al nichel  
Nickel plated AISI 303



6,5 cm - 2.55"



3 mm - 0.12"



18,5 cm - 7.28"



100 g - 3.52 oz



### FX-597 XTS

LINER LOCK

Con blocco di sicurezza L.A.W.K.S.  
With L.A.W.K.S.® safety lock

▼ Movimento con cuscinetti a sfera  
Ball bearing operating system

#### LAMA | BLADE

N690Co black idrogliker  
Black idrogliker N690Co  
HRC 58-60

#### MANICO | HANDLE

G10 nero  
Black G10

#### LINER LOCK

AISI 420 black idrogliker  
Black idrogliker AISI 420

Frangivetro in Tungsteno  
Tungsten glass breaker

#### ANELLO | RING

Alluminio anodizzato nero  
Black anodized aluminium

#### CLIP

Sagomata in AISI 420  
black idrogliker  
Black idrogliker shaped  
AISI 420

#### VITI | SCREWS

AISI 303 rivestito al nichel  
Nickel plated AISI 303



6,5 cm - 2.55"



3 mm - 0.12"



18,5 cm - 7.28"



100 g - 3.52 oz

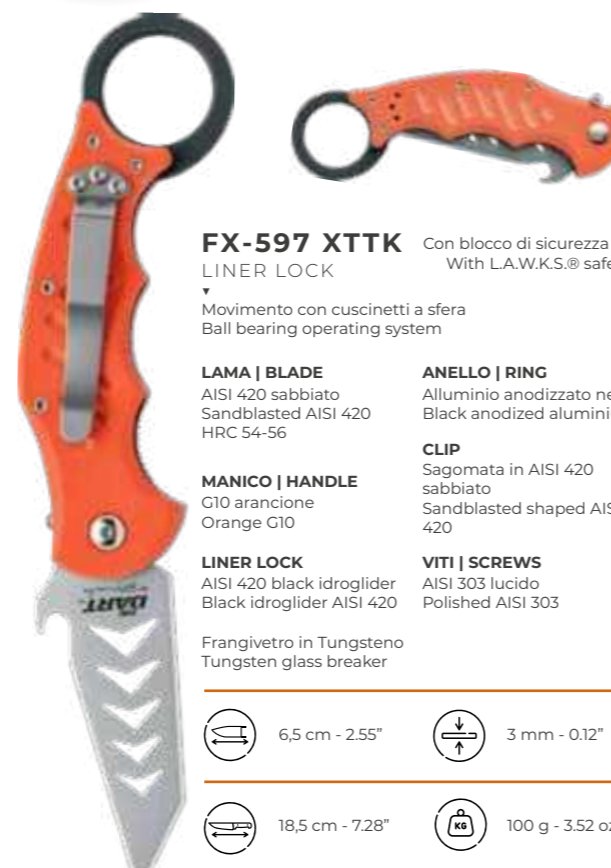

### FX-597 XTTK

LINER LOCK

Con blocco di sicurezza L.A.W.K.S.  
With L.A.W.K.S.® safety lock

▼ Movimento con cuscinetti a sfera  
Ball bearing operating system

#### LAMA | BLADE

AISI 420 sabbiato  
Sandblasted AISI 420  
HRC 54-56

#### MANICO | HANDLE

G10 arancione  
Orange G10

#### LINER LOCK

AISI 420 black idrogliker  
Black idrogliker AISI 420

Frangivetro in Tungsteno  
Tungsten glass breaker

#### ANELLO | RING

Alluminio anodizzato nero  
Black anodized aluminium

#### CLIP

Sagomata in AISI 420  
sabbiato  
Sandblasted shaped AISI  
420

#### VITI | SCREWS

AISI 303 lucido  
Polished AISI 303



6,5 cm - 2.55"



3 mm - 0.12"



18,5 cm - 7.28"



100 g - 3.52 oz



### MK TOOL

designed by Doug Marcaida

### FX-800 MK

BACK LOCK

▼ Movimento con cuscinetti a sfera  
Ball bearing operating system

130 g - 4.58 oz



18,5 cm - 7.28"

4 mm - 0.16"



6,5 cm - 2.55"



Con blocco di sicurezza  
With safety lock

Frangivetro in Tungsteno  
Tungsten glass breaker



N690Co Top Shield® nero  
Black Top Shield® N690Co  
HRC 58-60



G10 nero  
Black G10



AISI 420 black idrogliker  
Black idrogliker AISI 420



Alluminio anodizzato nero  
Black anodized aluminium



Sagomata in AISI 420 black idrogliker  
Black idrogliker shaped AISI 420



AISI 303 rivestito al nichel  
Nickel plated AISI 303



### MK TOOL

designed by Doug Marcaida

### FX-800 MKOR

BACK LOCK

▼ Movimento con cuscinetti a sfera  
Ball bearing operating system

130 g - 4.58 oz



18,5 cm - 7.28"

4 mm - 0.16"



6,5 cm - 2.55"



Con blocco di sicurezza  
With safety lock

Frangivetro in Tungsteno  
Tungsten glass breaker



N690Co Top Shield® nero  
Black Top Shield® N690Co  
HRC 58-60



G10 arancione  
Orange G10



AISI 420 black idrogliker  
Black idrogliker AISI 420



Alluminio anodizzato nero  
Black anodized aluminium



Sagomata in AISI 420 black idrogliker  
Black idrogliker shaped AISI 420



AISI 303 rivestito al nichel  
Nickel plated AISI 303



### MK TOOL

designed by Doug Marcaida

### FX-801 MK

FIXED BLADE

90 g - 3.17 oz



15,5 cm - 6.10"

4 mm - 0.16"



N690Co Top Shield® nero  
Black Top Shield® N690Co  
HRC 58-60



Sagomata in AISI 420 black idrogliker  
Black idrogliker shaped AISI 420



AISI 303 rivestito al nichel  
Nickel plated AISI 303 el

# FX-591 BLACKBIRD

designed by Bastinelli Design



Fodero in cuoio nero per le versioni in fibra di carbonio  
Black eather sheath for carbon fiber versions



## FX-591 TiC BR FRAME LOCK

Movimento con cuscinetti a sfera  
Ball bearing operating system

75 g - 2.65 oz



17 cm - 6.69"



3 mm - 0.12"



6,5 cm - 2.55"



## FX-591 TiC B FRAME LOCK

Movimento con cuscinetti a sfera  
Ball bearing operating system

75 g - 2.65 oz



17 cm - 6.69"



3 mm - 0.12"



6,5 cm - 2.55"



## FX-591 LINER LOCK

Movimento con cuscinetti a sfera  
Ball bearing operating system

110 g - 3.88 oz



17 cm - 6.69"



3 mm - 0.12"



6,5 cm - 2.55"



## FX-591 OD LINER LOCK

Movimento con cuscinetti a sfera  
Ball bearing operating system

110 g - 3.88 oz



17 cm - 6.69"



3 mm - 0.12"



6,5 cm - 2.55"



## FX-591 ODSW LINER LOCK

Movimento con cuscinetti a sfera  
Ball bearing operating system

110 g - 3.88 oz



17 cm - 6.69"



3 mm - 0.12"



6,5 cm - 2.55"



## FX-591 TK LINER LOCK

Movimento con cuscinetti a sfera  
Ball bearing operating system

110 g - 3.88 oz



17 cm - 6.69"



3 mm - 0.12"



6,5 cm - 2.55"

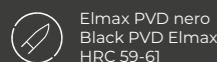

Elmax PVD nero  
Black PVD Elmax  
HRC 59-61



Fibra di carbonio 3K  
3K carbon fiber



Titanio anodizzato bronzo  
Bronze anodized titanium



Titanio anodizzato bronzo  
Bronze anodized titanium



Sagomata in titanio anodizzato bronzo  
Bronze anodized shaped titanium



AISI 303 black idrogliider  
Black idrogliider AISI 303



Elmax PVD nero  
Black PVD Elmax  
HRC 59-61



Fibra di carbonio 3K  
3K carbon fiber



Titanio PVD nero  
Black PVD titanium



Titanio PVD nero  
Black PVD titanium



Sagomata in titanio PVD nero  
Black PVD shaped titanium



AISI 303 black idrogliider  
Black idrogliider AISI 303



N690Co black idrogliider  
Black idrogliider N690Co  
HRC 58-60



G10 nero  
Black G10



AISI 420 black idrogliider  
Black idrogliider AISI 420



Alluminio anodizzato nero  
Black anodized aluminium



A filo in AISI 420 black idrogliider  
Black idrogliider wire clip AISI 420



AISI 303 black idrogliider  
Black idrogliider AISI 303



N690Co black idrogliider  
Black idrogliider N690Co  
HRC 58-60



G10 verde OD  
OD green G10



AISI 420 black idrogliider  
Black idrogliider AISI 420



Alluminio anodizzato nero  
Black anodized aluminium



A filo in AISI 420 black idrogliider  
Black idrogliider wire clip AISI 420



AISI 303 black idrogliider  
Black idrogliider AISI 303



N690Co stone washed  
Stone washed N690Co  
HRC 58-60



G10 verde OD  
OD green G10



AISI 420 black idrogliider  
Black idrogliider AISI 420



Alluminio anodizzato nero  
Black anodized aluminium



A filo in AISI 420 black idrogliider  
Black idrogliider wire clip AISI 420



AISI 303 black idrogliider  
Black idrogliider AISI 303



AISI 420 stone washed  
Stone washed AISI 420  
HRC 54-56



G10 blu  
Blue G10



AISI 420 black idrogliider  
Black idrogliider AISI 420



Alluminio anodizzato nero  
Black anodized aluminium



A filo in AISI 420 black idrogliider  
Black idrogliider wire clip AISI 420



AISI 303 rivestito al nichel  
Nickel plated AISI 303



## **LAMA FISSA FIXED BLADE**

La categoria dei coltelli fissi è la scelta per chi necessita di coltelli efficienti sempre all'altezza dei compiti più duri. I coltelli fissi Fox Knives sono realizzati con materiali di prima qualità, ricercati con attenzione da noti designers assieme al Fox Knives Team per garantire durabilità e affidabilità grazie anche allo studio dell'ergonomia che conferisce ai coltelli a lama fissa una solida impugnatura durante il lavoro. I coltelli Fox Knives sono prodotti Made in Italy.

The fixed knife category is the choice for those who need efficient knives that are always up to the toughest tasks. Fox fixed knives are made with top-quality materials carefully researched by well-known designers, together with the Fox Knives Team, to ensure durability and reliability thanks also to the study of ergonomics that gives fixed-blade knives a solid grip while working. Fox Knives are Made in Italy products.

# FX-106 EASTWOOD TIGER

designed by Gudy Van Poppel

Questo modello è stato disegnato da Gudy Von Poppel con l'idea di progettare un coltello tattico che fosse forte ed efficiente e che riuscisse ad evocare linee, caratteristiche e materiali classici. Operazione sicuramente riuscita soprattutto in questa nuova versione che garantisce una presa salda grazie anche alla guardia dalle dimensioni modeste che blocca l'impugnatura durante i lavori più difficili.

L'Eastwood Tiger è un coltello adatto alle situazioni outdoor grazie anche al suo pratico fodero in cuoio che permette un facile trasporto.

This model was designed by Gudy Von Poppel with the idea of designing a tactical knife that was strong and efficient and managed to evoke classic lines, features and materials. Operation certainly succeeded especially in this new version that provides a firm grip thanks also to the modestly sized guard that blocks the handle during the most difficult jobs. The Eastwood Tiger is a knife suitable for outdoor situations thanks also to its practical leather sheath that allows easy carrying.



Packaging per il modello in damasco  
+ fodero in cuoio nero  
Packaging for damascus model +  
black leather sheath

## FX-106 DCF FIXED BLADE

265 gr - 9.35 oz



24 cm - 9.45"



5 mm - 0.20"



11 cm - 4.33"



LIMITED EDITION - LIMITED EDITION

SuperClean® Damascus by  
Damastahl  
HRC 59-60

Uni Copper by FatCarbon®

AISI 303 PVD nero  
Black PVD AISI 303



Cuoio nero  
Black leather

300 gr - 10.58 oz



24 cm - 9.45"



5 mm - 0.20"



11 cm - 4.33"



## FX-106 TICF FIXED BLADE



Elmax PVD nero  
Black PVD Elmax  
HRC 59-61

Titanio sabbato + fibra di carbonio  
Sandblasted titanium + carbon  
fiber

AISI 303 PVD nero  
Black PVD AISI 303



Cuoio nero  
Black leather

295 gr - 10.41 oz



24 cm - 9.45"



5 mm - 0.20"



11 cm - 4.33"



## FX-106 TIZW FIXED BLADE



Elmax satinato  
Satin Elmax  
HRC 59-61

Titanio anodizzato bronzo + Zircote  
Bronze anodized titanium + Zircote  
wood

AISI 303 lucido  
Polished AISI 303



Kydex®

245 gr - 8.64 oz



24 cm - 9.45"



5 mm - 0.20"



11 cm - 4.33"



## FX-106 MIOD FIXED BLADE



Niolox stone washed  
Stone washed Niolox  
HRC 59-61

Micarta verde OD  
OD green Micarta

AISI 303 sabbato  
Sandblasted AISI 303



# FX-654 BILLAO

La reinterpretazione di Fox Knives del famoso coltello Billao è un omaggio al coltello tradizionale dell'equipaggiamento ufficiale della Polizia dell'Africa Italiana (PAI). Fox Knives ha voluto mantenere la coerenza storica e l'estetica autentica del coltello originale apportando miglioramenti per conferire robustezza grazie alle nuove tecnologia produttive.

L'impugnatura è realizzata in corno di bufalo, un materiale tradizionale che aggiunge autenticità al design. Il fodero è realizzato in cuoio e dispone di passanti e stringhe che permettono di fissarlo ai fianchi. È stato appositamente progettato per accogliere sia l'impugnatura che l'elsa, mantenendo la praticità e l'originalità del coltello Billao.

Oltre alla cura nell'estetica, Fox Knives ha lavorato per garantire solidità al coltello reinterpretato: la lama satinata in N690Co e l'impugnatura sono di alta qualità e resistenti alle sollecitazioni quotidiane. Questa combinazione di autenticità storica e durabilità moderna rende il Billao di Fox Knives un oggetto apprezzato sia dagli appassionati di coltelli che dagli amanti della storia.

Un omaggio al passato dell'Arma Italiana per preservare la tradizione e l'eredità.

Fox Knives' reinterpretation of the famous Billao knife is a tribute to the traditional knife of the official equipment of the Police of Italian Africa (PAI). Fox Knives wanted to maintain the historical consistency and authentic aesthetics of the original knife while making improvements to impart sturdiness through new manufacturing technology.

The handle is made of buffalo horn, a traditional material that adds authenticity to the design. The sheath is made of leather and has loops and strings that allow it to be attached to the hips. It is specially designed to accommodate both the handle and the hilt, maintaining the practicality and originality of the Billao knife.

In addition to care in aesthetics, Fox Knives has worked to ensure solidity for the reinterpreted knife: the satin-finished N690Co blade and handle are of high quality and resistant to everyday stresses. This combination of historical authenticity and modern durability makes the Billao by Fox Knives an item appreciated by knife enthusiasts and history lovers alike.

A tribute to the past of the Italian Army to preserve tradition and legacy.



Packaging + fodero in cuoio nero  
Packaging + Black leather sheath

## FX-654 CR FIXED BLADE

355 g - 12.52 oz



31 cm - 12.20"



5 mm - 0.20"



19,5 cm - 7.68"



N690Co satinato  
Satin N690Co  
HRC 58-60

Corno di Bufalo  
Buffalo horn

AISI 303 lucido  
Polished AISI 303



# FX-634 RYU

designed by Black Roc Knives



## FX-634 DCFB FIXED BLADE



**LAMA | BLADE**  
Herringbone Damascus by Balbach Damast®  
HRC 59-61

**MANICO | HANDLE**  
Black camo by Fatcarbon®

**VITI | SCREWS**  
Titanio PVD nero  
Black PVD titanium



Packaging per il modello in damasco + fodero in cuoio nero  
Packaging for damascus model + black leather sheath



Kydex®

### FX-634 FIXED BLADE

**LAMA | BLADE**  
Nilox stone washed black idroglider  
Black idroglider stone washed Nilox  
HRC 59-61

**MANICO | HANDLE**  
G10 nero  
Black G10

**VITI | SCREWS**  
AISI 303 black idroglider  
Black idroglider AISI 303

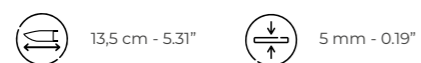

Kydex®

### FX-634 MOD FIXED BLADE

**LAMA | BLADE**  
Nilox coarse stone washed  
Coarse stone washed Nilox  
HRC 59-61

**MANICO | HANDLE**  
Micarta verde  
Green Micarta

**VITI | SCREWS**  
AISI 303 black idroglider  
Black idroglider AISI 303

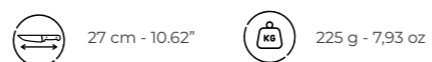
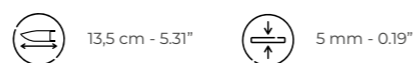

# FX-553 & FX-554 AKA

designed by Anarcnide



## FX-553 B FIXED BLADE

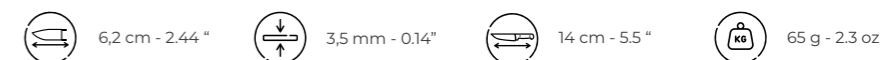

**LAMA | BLADE**  
Elmax Top Shield® nero  
Black Top Shield® Elmax  
HRC 59-61

**MANICO | HANDLE**  
G10 nero  
Black G10

**VITI | SCREWS**  
AISI 303 black idroglider  
Black idroglider AISI 303



Kydex®



## FX-554 B FIXED BLADE



**LAMA | BLADE**  
Elmax Top Shield® nero  
Black Top Shield® Elmax  
HRC 59-61

**MANICO | HANDLE**  
G10 nero  
Black G10

**VITI | SCREWS**  
AISI 303 black idroglider  
Black idroglider AISI 303



Kydex®



Kydex®



Cuoio nero e Nylon®  
Black leather and Nylon®



Cuoio nero  
Black leather



Cuoio nero  
Black leather



Kydex® con belt loops  
Kydex® with belt loops



Kydex® con belt loops  
Kydex® with belt loops

**TUR**

designed by Vox

**FX-529 TR**  
FIXED BLADE

168 gr - 5.93 oz



22 cm - 8.66"



4 mm - 0.16"



11 cm - 4.33"



N690Co black idrogliker stone washed  
Black idrogliker stone washed N690Co  
HRC 58-60

G10 tricolore  
Tricolor G10

AISI 303 black idrogliker  
Black idrogliker AISI 303

**CORE SCANDI**

designed by Vox

**FX-606**  
FIXED BLADE

150 g - 5.29 oz



23.5 cm - 9.25"



4 mm - 0.16"



10 cm - 3.93"



Becut satinato  
Satin Becut  
HRC 56-58

PP+TPE nero  
Black PP+TPE

**OCTOPUS VULGARIS**

designed by Tommaso Rumici

**FX-510**  
FIXED BLADE

190 g - 6.70 oz



24 cm - 9.45"



5 mm - 0.20"



11.5 cm - 4.52"



N690Co stone washed  
Stone washed N690Co  
HRC 58-60

G10 nero  
Black G10

AISI 303 PVD lucido  
Polished PVD AISI 303

**OCTOPUS VULGARIS**

designed by Tommaso Rumici

**FX-510 OD**  
FIXED BLADE

190 g - 6.70 oz



24 cm - 9.45"



5 mm - 0.20"



11.5 cm - 4.52"



N690Co stone washed  
Stone washed N690Co  
HRC 58-60

G10 verde OD  
OD green G10

AISI 303 PVD lucido  
Polished PVD AISI 303

**MONKEY THUMPER**

designed by Black Roc Knives

**FX-633**  
FIXED BLADE

165 g - 5.82 oz



21.5 cm - 8.46"



4 mm - 0.16"



9 cm - 3.54"



Niolox black idrogliker stone washed  
Black idrogliker stone washed Niolox  
HRC 59-61

G10 nero  
Black G10

AISI 303 black idrogliker  
Black idrogliker AISI 303

**MONKEY THUMPER**

designed by Black Roc Knives

**FX-633 MOD**  
FIXED BLADE

165 g - 5.82 oz



21.5 cm - 8.46"



4 mm - 0.16"



9 cm - 3.54"



Niolox coarse stone washed  
Coarse stone washed Niolox  
HRC 59-61

Micarta verde  
Green Micarta

AISI 303 black idrogliker  
Black idrogliker AISI 303

# FX-623

## URO

designed by Dino Picco - in collaboration with Wander Tactical



### FX-623 BA

#### FIXED BLADE

NEW ITEM

|   |  |   |   |
|---|--|---|---|
|  15,5 cm - 6.10" |  5,8 mm - 0.23" |  30 cm - 11.8" |  410 g - 14.5 oz |
|---|--|---|---|

**LAMA | BLADE**  
Acid washed Niolox  
HRC 59-61

**MANICO | HANDLE**  
G10 nero  
Black G10

**VITI | SCREWS**  
AISI 303 sabbaiato  
Sandblasted AISI 303



Kydex®



### FX-623 ODA

#### FIXED BLADE

NEW ITEM

|   |  |   |   |
|---|--|---|---|
|  15,5 cm - 6.10" |  5,8 mm - 0.23" |  30 cm - 11.8" |  400 g - 14.1 oz |
|---|--|---|---|

**LAMA | BLADE**  
Acid washed Niolox  
HRC 59-61

**MANICO | HANDLE**  
Micarta verde OD  
OD green Micarta

**VITI | SCREWS**  
AISI 303 PVD nero  
Black PVD AISI 303



Kydex®

L'Uro è un coltello progettato per coniugare potenza, agilità e versatilità, rispondendo efficacemente a un'ampia gamma di utilizzi e soddisfacendo anche le esigenze degli utenti più esigenti. Il suo sviluppo è il risultato di un anno di test rigorosi e prove condotte in condizioni estreme, durante il quale il design è stato progressivamente affinato per garantire prestazioni ottimali in qualsiasi contesto operativo. Grazie alla sua combinazione di funzionalità avanzate ed ergonomia meticolosamente studiata, l'Uro è oggi uno dei coltelli più apprezzati sul mercato, scelto sia da escursionisti esperti che da professionisti del settore militare a livello internazionale.

The Uro is a knife designed to combine power, agility and versatility, responding effectively to a wide range of uses and meeting the needs of even the most demanding users. Its development is the result of a year of rigorous testing and trials conducted under extreme conditions, during which the design was progressively refined to ensure optimal performance in any operational context. Thanks to its combination of advanced features and meticulously designed ergonomics, the Uro is now one of the most popular knives on the market, chosen by both experienced hikers and military professionals internationally.





## FX-GAL-20

COLTELLO DA IMMERSIONE GALEAZZI - GALEAZZI DIVING KNIFE

127

Fox Knives presenta la reinterpretazione del famoso coltello da palombaro Galeazzi, originariamente realizzato a metà degli anni Cinquanta per gli uomini rana dell'unità Comsubin della Marina Militare Italiana. Il coltello è stato meticolosamente ricreato seguendo i disegni storici in ogni dettaglio. Anche il fodero, realizzato in gomma, e la sua scatola rispecchiano il modello originale sia nella forma che nel colore.

Un lato del coltello è arricchito da un bordo seghettato. Questo bordo viene utilizzato per tagliare la corda e altri materiali ad alta fibra. L'altro lato della lama è dotato di un bordo liscio. Perfetto per tutti gli altri lavori di taglio. La lama è realizzata in 420, un tipo di acciaio inossidabile facile da affilare, ideale per un coltello da immersione. Il manico è realizzato in G10 nero. Per garantire una presa sufficiente, il coltello è dotato di una struttura ruvida. La parte superiore del manico è arricchita da un'ampia protezione a doppia faccia. La base del manico è dotata di una chiave regolabile. Può essere regolata con l'aiuto dell'ingranaggio nel manico.

Fox Knives presents the reinterpretation of the famous Galeazzi diver's knife, originally crafted in the mid-1950s for the frogmen of the Italian Navy's Comsubin unit. The knife has been meticulously recreated following historical designs in every detail. Even the sheath, made of rubber, and its box mirror the original model in both shape and color.

One side of the blade is enhanced with a serrated edge. This edge is used to cut through rope and other high-fibre materials. The other side of the blade is enhanced with a smooth edge. Perfect for all other cutting tasks. The blade is made from 420C, a stainless type of steel that is easy to sharpen, great for a diving knife.

The handle is made from black G10. To make sure you have enough grip the knife is enhanced with a rough structure. The top of the handle is enhanced with a broad, double-sided guard. The base of the handle is equipped with an adjustable key. It can be adjusted with the help of the gear in the handle.

### FX-GAL-20 FIXED BLADE

585 g - 20.63 oz



24 cm - 9.44"



6 mm - 0.24"



14,5 cm - 5.7"



AISI 420 satinato  
Satin AISI 420  
HRC 54-56



G10 nero  
Black G10



AISI 303 lucido  
Polished AISI 303



Cuoio nero  
Black leather



# FX-105 & FX-103

designed by Markus Reichart

## TOKALA FX-105 MB FIXED BLADE

235 g - 8.28 oz

23,7 cm - 9.33"

5 mm - 0.20"

11,6 cm - 4.56"

Nilox black idroglider  
stone washed  
Black idroglider stone  
washed Nilox  
HRC 59-61

Micarta Bison  
Bison Micarta

AISI 303 lucido  
Polished AISI 303

Alluminio lucido  
Polished aluminium



Cuoio nero  
Black leather

## FX-103 MB FIXED BLADE

245 g - 8.64 oz

23,1 cm - 9.09"

5 mm - 0.20"

11,5 cm - 4.52"

Nilox sabbiato  
Sandblasted Nilox  
HRC 59-61

Micarta nera + guardia AISI 303  
sabbiato  
Black Micarta + Sandblasted AISI  
303 guard

AISI 303 PVD sabbiato  
Sandblasted AISI 303



Cuoio nero  
Black leather

# FX-143 MB & FX-140XL

designed by Markus Reichart



## FX-143 MB FIXED BLADE

9,7 cm - 3.81" 4 mm - 0.15" 20,7 cm - 8.14" 115 g - 4.06 oz

**LAMA | BLADE**  
Nilox satinato  
Polished Nilox  
HRC 59-61

**MANICO | HANDLE**  
Micarta nera  
Black Micarta

**BOCCOLE | BUSHINGS**  
AISI 303 PVD lucido  
Polished AISI 303



Cuoio nero  
Black leather



## FX-140XL MB FIXED BLADE

18,6 cm - 7.32" 5 mm - 0.19" 31,5 cm - 12.4" 370 g - 13.05 oz

**LAMA | BLADE**  
Nilox satinato  
Polished Nilox  
HRC 59-61

**MANICO | HANDLE**  
Micarta nera  
Black Micarta

**BOCCOLE | BUSHINGS**  
AISI 303 PVD lucido  
Polished AISI 303



Cuoio nero  
Black leather

# FX-611

## FOX NATIVE BUSHCRAFT



### FX-611

#### FIXED BLADE

37,5 g - 13,22 oz



30 cm - 11,81"



5 mm - 0,20"





17,5 cm - 6,89"



Cuoio nero  
Black leather

 D2 black idrogliider stone washed  
Black idrogliider stone washed D2  
HRC 59-61

 Micarta nera sabbiata  
Sandblasted black Micarta

 AISI 303 black idrogliider  
Black idrogliider AISI 303



Cuoio nero  
Black leather

### SHERPA

#### FX-610

##### FIXED BLADE

**LAMA | BLADE**  
D2 black idrogliider stone washed  
Black idrogliider stone washed D2  
HRC 59-61

**MANICO | HANDLE**  
Micarta verde OD  
OD green Micarta

**VITI | SCREWS**  
AISI 303 black idrogliider  
Black idrogliider AISI 303



14 cm - 5.51"



5 mm - 0.19"



28,5 cm - 11.22"



341 g - 12.02 oz



Nylon®

### TRAPPER

#### FX-132 MGT

##### FIXED BLADE

**LAMA | BLADE**  
N690co black idrogliider  
Black idrogliider N690Co  
HRC 58-60

**MANICO | HANDLE**  
Micarta verde OD  
OD green Micarta

**VITI | SCREWS**  
AISI 303 black idrogliider  
Black idrogliider AISI 303



17 cm - 6.69"



6 mm - 0.24"



30 cm - 11.81"



360 g - 12.70 oz



Cuoio nero  
Black leather

### BUSHMAN

#### FX-609 OD

##### FIXED BLADE

**LAMA | BLADE**  
D2 black idrogliider stone washed  
Black idrogliider stone washed D2  
HRC 59-61

**MANICO | HANDLE**  
Micarta verde OD  
OD green Micarta

**VITI | SCREWS**  
AISI 303 black idrogliider  
Black idrogliider AISI 303



16 cm - 6.29"



5 mm - 0.19"



29 cm - 11.41"



370 g - 13.05 oz



Nylon®

### COMBAT JUNGLE

#### FX-133 MGT

##### FIXED BLADE

**LAMA | BLADE**  
N690co black idrogliider  
Black idrogliider N690Co  
HRC 58-60

**MANICO | HANDLE**  
Micarta verde OD  
OD green Micarta

**VITI | SCREWS**  
AISI 303 black idrogliider  
Black idrogliider AISI 303



19 cm - 7.48"



6 mm - 0.24"



32 cm - 12.59"



365 g - 12.87 oz

# FX-616

## OXYLOS

### FX-616 OL

FIXED BLADE

265 gr - 9.34 oz



24,5 cm - 9.65"



5 mm - 0.20"



13,5 cm - 5.31"



Cuoio nero  
Black leather



N690Co satinato  
Satin N690Co  
HRC 58-60



Ulivo  
Olive wood



AISI 303 lucido  
Polished AISI 303

### FX-616 MB

FIXED BLADE

272 gr - 9.59 oz



24,5 cm - 9.65"



5 mm - 0.20"



13,5 cm - 5.31"



Cuoio nero  
Black leather



N690Co stone washed  
Stone washed N690Co  
HRC 58-60



Micarta nera  
Black Micarta



AISI 303 lucido  
Polished AISI 303



# FX-649

## FENIX

designed by Yevgeny Khokhlovcal

### FX-649 OL

FIXED BLADE



180 gr - 6.35 oz



24,5 cm - 9.65"



4,5 mm - 0.17"



12 cm - 4.72"



Nilox satinato  
Satin Nilox  
HRC 59-61

Ulivo  
Olive wood

AISI 303 lucido  
Polished AISI 303

### FX-649 SA

FIXED BLADE



183 gr - 6.45 oz



24,5 cm - 9.65"



4,5 mm - 0.17"



12 cm - 4.72"



Nilox satinato  
Satin Nilox  
HRC 59-61

Santos  
Santos wood

AISI 303 lucido  
Polished AISI 303

# FX-131

## PRO HUNTER

### FX-131 DW

FIXED BLADE



190 gr - 6.70 oz



23 cm - 9.05"



5 mm - 0.19"



11 cm - 4.33"



N690Co satinata  
Satin N690Co  
HRC 58-60

Santos  
Santos wood

AISI 303 lucido  
Polished AISI 303

### FX-131 MBSW

FIXED BLADE



210 gr - 7.41 oz



23 cm - 9.05"



5 mm - 0.19"



11 cm - 4.33"



N690Co stone washed  
Stone washed N690Co  
HRC 58-60

Micarta nera  
Black Micarta

AISI 303 sabbato  
Sandblasted AISI 303



# TK-FX01 EGO

designed by Alfredo Doricchi

La collaborazione tra Fox Knives e Tops Knives ha dato vita ad un capolavoro: il nuovo coltello a lama fissa "Ego", un prodotto che unisce il meglio della innovazione e della tradizione. Disegnato da Alfredo Doricchi, l'Ego è il risultato di una perfetta sinergia tra la creatività italiana e l'artigianalità americana. Fox Knives ha sviluppato il progetto tecnico con la massima precisione, che è stato poi realizzato da Tops Knives direttamente negli Stati Uniti, nel loro stabilimento nello stato dell'Idaho, utilizzando materiali di altissima qualità e curando i minimi particolari. Questa collaborazione rappresenta non solo l'unione di due marchi di prestigio, ma anche l'incontro tra due culture di eccellenza, entrambe riconosciute per l'impegno verso l'innovazione e la qualità nel mondo della coltelleria.

The collaboration between Fox Knives and Tops Knives has resulted in a masterpiece: the new "Ego" fixed-blade knife, a product that combines the best of innovation and tradition. Designed by Alfredo Doricchi, the Ego is the result of a perfect synergy between Italian creativity and American craftsmanship. Fox Knives developed the technical design with the utmost precision, which was then made by Tops Knives directly in the United States, in their factory in the state of Idaho, using the highest quality materials and taking care of the smallest details. This collaboration represents not only the union of two prestigious brands, but also the meeting of two cultures of excellence, both recognized for their commitment to innovation and quality in the world of cutlery.

## TK-FX01 FIXED BLADE

NEW  
ITEM

250 g - 8.81 oz



22 cm - 8.66"



4,5 mm - 0.18"



9.6 cm - 3.77"



Acciaio al carbonio 1095  
1095 carbon steel  
HRC 57-58

G10 nero-coyote tan  
Black-coyote tan G10

AISI 303 black idroglider  
Black idroglider AISI 303



Kydex®





# RIFLE

## SERIE DA CACCIA | HUNTING SERIES

designed by Raven Knives Design

### WINDAGE FX-661 OL FIXED BLADE

183 gr - 6,45 oz

22,8 cm - 8,98"

4 mm - 0,15"

10,7 cm - 4,21"

Becut satinato  
Satin BeCut  
HRC 56-58

Ulivo  
Olive wood

AISI 303 lucido  
Polished AISI 303



Cuoio nero  
Black leather



### WINDAGE FX-661 OR FIXED BLADE

215 gr - 7,58 oz

22,8 cm - 8,98"

4 mm - 0,15"

10,7 cm - 4,21"

Becut acid stone washed  
Acid stone washed BeCut  
HRC 56-58

G10 arancione  
Orange G10

AISI 303 lucido  
Polished AISI 303



Cuoio nero  
Black leather



La linea Rifle è stata sviluppata per rispondere alla crescente domanda di coltelli da caccia classici, solidi e maneggevoli. Con quattro tipi di lame - il drop point, il clip point e una lama specifica per la scuoiatura - la linea Rifle garantisce una versatilità senza pari, ideale sia per la caccia che per le escursioni nel bushcraft. I manici ergonomici assicurano una presa sicura e confortevole durante l'uso prolungato, mentre l'acciaio inossidabile delle lame sottoposte a trattamenti termici assicura una durata del filo superiore.

The Rifle line was developed to meet the growing demand for classic, sturdy, and easy-to-handle hunting knives. With four types of blades - the drop point, the clip point, and a specific skinning blade - the Rifle line ensures unparalleled versatility, ideal for both hunting and bushcraft excursions. The ergonomic handles provide a secure and comfortable grip during extended use, while the stainless steel blades, subjected to heat treatments, ensure superior edge retention.

**RECEIVER  
FX-662 OL**  
FIXED BLADE

183 gr - 6.45 oz

22,8 cm - 8.98"

4 mm - 0.15"

10,7 cm - 4.21"

Cuoio nero  
Black leather

Becut satinato  
Satin Becut  
HRC 56-58

Ulivo  
Olive wood

AISI 303 lucido  
Polished AISI 303

**RECEIVER  
FX-662 OR**  
FIXED BLADE

215 gr - 7.58 oz

22,8 cm - 8.98"

4 mm - 0.15"

10,7 cm - 4.21"

Cuoio nero  
Black leather

Becut acid stone washed  
Acid stone washed Becut  
HRC 56-58

G10 arancione  
Orange G10

AISI 303 lucido  
Polished AISI 303



**EJECTOR  
FX-663 OL**  
FIXED BLADE

**LAMA | BLADE**  
Becut satinato  
Satin Becut  
HRC 56-58

**MANICO | HANDLE**  
Ulivo  
Olive wood

**VITI | SCREWS**  
AISI 303 lucido  
Polished AISI 303

11,1 cm - 4.37"      4 mm - 0.15"

23,2 cm - 9.13"      183 gr - 6.45 oz



**EJECTOR  
FX-663 OR**  
FIXED BLADE

**LAMA | BLADE**  
Becut acid stone washed  
Acid stone washed Becut  
HRC 56-58

**MANICO | HANDLE**  
G10 arancione  
Orange G10

**VITI | SCREWS**  
AISI 303 lucido  
Polished AISI 303

11,1 cm - 4.37"      4 mm - 0.15"

23,2 cm - 9.13"      215 gr - 7.58 oz



**MUZZLE  
FX-664 OL**  
FIXED BLADE

**LAMA | BLADE**  
Becut satinato  
Satin Becut  
HRC 56-58

**MANICO | HANDLE**  
Ulivo  
Olive wood

**VITI | SCREWS**  
AISI 303 lucido  
Polished AISI 303

8 cm - 3.14"      4 mm - 0.15"

18,6 cm - 7.32"      150 gr - 5.29 oz



**MUZZLE  
FX-664 OR**  
FIXED BLADE

**LAMA | BLADE**  
Becut acid stone washed  
Acid stone washed Becut  
HRC 56-58

**MANICO | HANDLE**  
G10 arancione  
Orange G10

**VITI | SCREWS**  
AISI 303 lucido  
Polished AISI 303

19 cm - 7.48"      4 mm - 0.15"

32 cm - 12.59"      170 gr - 5.99 oz



Cuoio nero  
Black leather

### ALASKAN HUNTER

**FX-620 B**  
FIXED BLADE

**LAMA | BLADE**  
Becut black idrogliider  
Black idrogliider Becut  
HRC 56-58

**MANICO | HANDLE**  
G10 nero  
Black G10

**VITI | SCREWS**  
AISI 303 rivestito al nichel  
Nickel plated AISI 303

9 cm - 3.54" 4 mm - 0.15"

22,5 cm - 8.85" 195 g - 6.87 oz



Cuoio nero  
Black leather

### ALASKAN HUNTER

**FX-621 B**  
FIXED BLADE

**LAMA | BLADE**  
Becut black idrogliider  
Black idrogliider Becut  
HRC 56-58

**MANICO | HANDLE**  
G10 nero  
Black G10

**VITI | SCREWS**  
AISI 303 rivestito al nichel  
Nickel plated AISI 303

11 cm - 4.33" 4 mm - 0.15"

24,5 cm - 9.64" 190 g - 6.70 oz



Cuoio marrone  
Brown leather

### EUROPEAN HUNTER

**1504 OL**  
FIXED BLADE

**LAMA | BLADE**  
N690Co black idrogliider  
Black idrogliider N690Co  
HRC 58-60

**MANICO | HANDLE**  
Ulivo  
Olive wood

**VITI | SCREWS**  
AISI 303 rivestito al nichel  
Nickel plated AISI 303

8,5 cm - 3.34" 4 mm - 0.15"

19,5 cm - 7.67" 185 g - 6.52 oz



Cuoio marrone  
Brown leather

### EUROPEAN HUNTER

**1505 OL**  
FIXED BLADE

**LAMA | BLADE**  
N690Co black idrogliider  
Black idrogliider N690Co  
HRC 58-60

**MANICO | HANDLE**  
Ulivo  
Olive wood

**VITI | SCREWS**  
AISI 303 rivestito al nichel  
Nickel plated AISI 303

8,5 cm - 3.34" 4 mm - 0.15"

19,5 cm - 7.67" 185 g - 6.52 oz



Cuoio marrone  
Brown leather

### EUROPEAN HUNTER

**1502 OL**  
FIXED BLADE

**LAMA | BLADE**  
N690Co black idrogliider  
Black idrogliider N690Co  
HRC 58-60

**MANICO | HANDLE**  
Ulivo  
Olive wood

**VITI | SCREWS**  
AISI 303 rivestito al nichel  
Nickel plated AISI 303

9,5 cm - 3.74" 4 mm - 0.15"

20 cm - 7.87" 185 g - 6.52 oz



Cuoio marrone  
Brown leather

### EUROPEAN HUNTER

**1503 OL**  
FIXED BLADE

**LAMA | BLADE**  
N690Co black idrogliider  
Black idrogliider N690Co  
HRC 58-60

**MANICO | HANDLE**  
Ulivo  
Olive wood

**VITI | SCREWS**  
AISI 303 rivestito al nichel  
Nickel plated AISI 303

9,5 cm - 3.74" 4 mm - 0.15"

20 cm - 7.87" 185 g - 6.52 oz



Cuoio marrone  
Brown leather

### EUROPEAN HUNTER

**1506 OL**  
FIXED BLADE

**LAMA | BLADE**  
N690Co black idrogliider  
Black idrogliider N690Co  
HRC 58-60

**MANICO | HANDLE**  
Ulivo  
Olive wood

**VITI | SCREWS**  
AISI 303 rivestito al nichel  
Nickel plated AISI 303

6,5 cm - 2.55" 4 mm - 0.15"

11,5 cm - 4.52" 130 g - 4.58 oz



Cuoio marrone  
Brown leather

### EUROPEAN HUNTER

**1507 OL**  
FIXED BLADE

**LAMA | BLADE**  
N690Co black idrogliider  
Black idrogliider N690Co  
HRC 58-60

**MANICO | HANDLE**  
Ulivo  
Olive wood

**VITI | SCREWS**  
AISI 303 rivestito al nichel  
Nickel plated AISI 303

6,5 cm - 2.55" 4 mm - 0.15"

11,5 cm - 4.52" 130 g - 4.58 oz



# FX-592 & FX-593

## FAIRBAIRN SYKES FIGHTING KNIFE

designed by Hill Knives



### FX-593

Versione con lama ad un filo  
Single edge blade version

### FX-593 AF

#### FIXED BLADE



#### LAMA | BLADE

N690Co satinato  
Satin N690Co  
HRC 58-60

#### MANICO | HANDLE

Noce  
Walnut wood



Cuoio nero  
Black leather



Cuoio nero  
Black leather

### FX-592 AF

#### FIXED BLADE

LAMA | BLADE  
N690Co PVD nero  
Black PVD N690Co  
HRC 58-60

MANICO | HANDLE  
Alluminio anodizzato nero  
Black anodized Aluminium

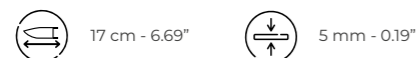

Cuoio nero  
Black leather

### FX-592 WAF

#### FIXED BLADE

LAMA | BLADE  
N690Co PVD nero  
Black PVD N690Co  
HRC 58-60

MANICO | HANDLE  
Noce  
Walnut wood



### KUKRI

#### 658

#### FIXED BLADE



630 g - 22.22 oz



41 cm - 16.14"



5 mm - 0.19"



26 cm - 10.23"



4119 nitro-B black idrogliker  
Black idrogliker 4119 nitro-B  
HRC 55-57

FRN® nero  
Black FRN®

AISI 303 rivestito al nichel  
Nickel plated AISI 303

### GURKHA

#### 660

#### FIXED BLADE



875 g - 30.86 oz



47 cm - 18.50"



6.5 mm - 0.26"



32 cm - 12.59"



AISI 440 black idrogliker  
Black idrogliker AISI 440  
HRC 55-57

FRN® nero  
Black FRN®

AISI 303 rivestito al nichel  
Nickel plated AISI 303

# FX-693, FX-694 & FX-695

## MACHETE

### JUNGLE LATIN MACHETE



#### FX-693

FIXED BLADE



**LAMA | BLADE**  
AISI 440 black idroglider  
Black idroglider AISI 440  
HRC 55-57

**MANICO | HANDLE**  
FRN® nero  
Black FRN®

**VITI | SCREWS**  
AISI 303 rivestito al nichel  
Nickel plated AISI 303



Cuoio nero  
Black leather



#### JUNGLE PARANG MACHETE

##### FX-694

FIXED BLADE

**LAMA | BLADE**  
1.4116 Bestar black idroglider  
Black idroglider 1.4116 Bestar  
HRC 56-58

**MANICO | HANDLE**  
FRN® nero  
Black FRN®

**VITI | SCREWS**  
AISI 303 rivestito al nichel  
Nickel plated AISI 303

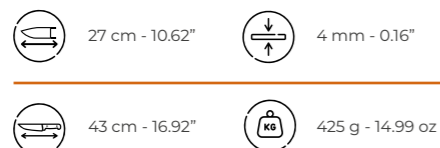

#### JUNGLE BOLO MACHETE

##### FX-695

FIXED BLADE

**LAMA | BLADE**  
1.4116 Bestar black idroglider  
Black idroglider 1.4116 Bestar  
HRC 56-58

**MANICO | HANDLE**  
FRN® nero  
Black FRN®

**VITI | SCREWS**  
AISI 303 rivestito al nichel  
Nickel plated AISI 303

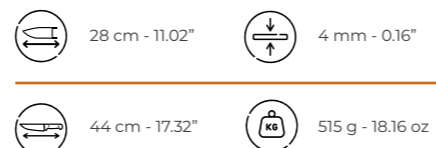

Cuoio marrone  
Brown leather

#### PATHFINDER

##### FX-679

FIXED BLADE

**LAMA | BLADE**  
1.4116 Bestar satinato  
Satin 1.4116 Bestar  
HRC 56-58

**MANICO | HANDLE**  
FRN® nero  
Black FRN®

**VITI | SCREWS**  
AISI 303 rivestito al nichel  
Nickel plated AISI 303



Cuoio nero  
Black leather

#### MACHO

##### 683

FIXED BLADE

**LAMA | BLADE**  
1.4116 Bestar satinato  
Satin 1.4116 Bestar  
HRC 56-58

**MANICO | HANDLE**  
FRN® nero  
Black FRN®

**VITI | SCREWS**  
AISI 303 rivestito al nichel  
Nickel plated AISI 303



Cuoio nero  
Black leather

#### MACHO 2

##### 680

FIXED BLADE

**LAMA | BLADE**  
1.4116 Bestar satinato  
Satin 1.4116 Bestar  
HRC 56-58

**MANICO | HANDLE**  
FRN® nero  
Black FRN®

**VITI | SCREWS**  
AISI 303 rivestito al nichel  
Nickel plated AISI 303



Cuoio nero  
Black leather

#### MACHO 2

##### 680 T

FIXED BLADE

**LAMA | BLADE**  
1.4116 Bestar black idroglider  
Black idroglider 1.4116 Bestar  
HRC 56-58

**MANICO | HANDLE**  
FRN® nero  
Black FRN®

**VITI | SCREWS**  
AISI 303 rivestito al nichel  
Nickel plated AISI 303





**682**  
FIXED BLADE

 14 cm - 5.51"
  4 mm - 0.16"
  35 cm - 13.77"
  440 g - 15.52 oz

**LAMA | BLADE**

1.4116 Bestar satinato  
Satin 1.4116 Bestar  
HRC 56-58



**MANICO | HANDLE**  
Frassino naturale  
Natural Sassafras wood





**682 M**  
FIXED BLADE

**LAMA | BLADE**  
1.4116 Bestar satinato  
Satin 1.4116 Bestar  
HRC 56-58

**MANICO | HANDLE**  
Frassino marrone  
Brown Sassafras wood

 14 cm - 5.51"
  3,5 mm - 0.14"

---



 35 cm - 13.77"
  440 g - 15.52 oz





**682 N**  
FIXED BLADE

**LAMA | BLADE**  
1.4116 Bestar satinato  
Satin 1.4116 Bestar  
HRC 56-58

**MANICO | HANDLE**  
Frassino nero  
Black Sassafras wood

 14 cm - 5.51"
  3,5 mm - 0.14"

---

 35 cm - 13.77"
  440 g - 15.52 oz

**YANKEE**  
**FX-700**  
FIXED BLADE

900 g - 31.75 oz



38 cm - 14.96"



8 cm - 3.15"



27,50 mm - 1.08"



Cuoio marrone  
Brown leather

 C45 carbon steel brunita  
Brunished C45 carbon steel  
HRC 55-57

 Frassino marrone  
Brown Sassafras wood

**SEKIRA**  
**FX-701**  
FIXED BLADE

1520 g - 53.62 oz



60 cm - 23.62"



11 mm - 4.33"



37,5 cm - 14.76"



Cuoio marrone  
Brown leather

 C45 carbon steel brunita  
Brunished C45 carbon steel  
HRC 55-57

 Hickory color noce  
Hickory wood finishing walnut



## **MULTIUSO-UTILITY-AGRICOLTURA-RESCUE** MULTIPURPOSE-UTILITY-AGRICULTURE-RESCUE

Che sia per i piccoli o grandi lavori di tutti i giorni, nelle escursioni più avventurose, o in contesti specifici come l'agricoltura o le operazioni di soccorso, avere con sé uno strumento affidabile permette di affrontare al meglio ogni difficoltà. Fox Knives offre strumenti con un'ampia scelta di usi e funzioni dedicati a diversi tipi di utenti che necessitano di un coltello che possa supportarli nelle diverse attività quotidiane o professionali. I coltelli Fox Knives sono prodotti Made in Italy.

Whether it is for small or large everyday jobs, in the most adventurous hikes, or in specific contexts such as agriculture or rescue operations, having a reliable tool with you allows you to face any difficulty to the best of your ability. Fox Knives offers tools with a wide range of uses and functions dedicated to different types of users who need a knife that can support them in different daily or professional activities. Fox Knives knives are Made in Italy products.

# VULPIS

## GRENADE PATTERN

KNIFE VERSION

Il manico del Vulpis si arricchisce: la serie di rilievi di questo nuovo pattern offre un'impugnatura eccezionalmente sicura e confortevole, che conferisce al coltello un aspetto robusto. Con l'aggiunta della clip, il suo carattere pratico e resistente viene sottolineato: il Vulpis diventa uno strumento ideale sia per usi quotidiani che per avventure outdoor.

The handle of the Vulpis is enhanced: the series of reliefs in this new pattern offer an exceptionally secure and comfortable grip, giving the knife a sturdy appearance. With the addition of the clip, its practical and durable character is emphasized: the Vulpis becomes an ideal tool for both everyday use and outdoor adventures.



### FX-VPGP130 TI

SLIP JOINT

38 g - 1.34 oz



13,5 cm - 5.31"



2 mm - 0.07"



5,5 cm - 2.16"



M390 lucida  
Polished M390  
HRC 59-61

Titanio sabbato  
Sandblasted titanium

Sagomata in AISI 420 lucido  
Polished shaped AISI 420

AISI 303 lucido  
Polished AISI 303



NEW  
ITEM



### FX-VPGP130 BK

SLIP JOINT

NEW  
ITEM

LAMA | BLADE  
N690Co lucida  
Polished N690Co  
HRC 58-60

MANICO | HANDLE  
Alluminio anodizzato nero  
Black anodized aluminium

CLIP  
Sagomata in AISI 420 lucido  
Polished shaped AISI 420

RIVETTI | RIVETS  
AISI 303 lucido  
Polished AISI 303

5,5 cm - 2.16"

2 mm - 0.07"

13,5 cm - 5.31"

30 g - 1.06 oz



### FX-VPGP130 RD

SLIP JOINT

NEW  
ITEM

LAMA | BLADE  
N690Co lucida  
Polished N690Co  
HRC 58-60

MANICO | HANDLE  
Alluminio anodizzato rosso  
Red anodized aluminium

CLIP  
Sagomata in AISI 420 lucido  
Polished shaped AISI 420

RIVETTI | RIVETS  
AISI 303 lucido  
Polished AISI 303

5,5 cm - 2.16"

2 mm - 0.07"

13,5 cm - 5.31"

30 g - 1.06 oz



### FX-VPGP130 MG

SLIP JOINT

NEW  
ITEM

LAMA | BLADE  
N690Co lucida  
Polished N690Co  
HRC 58-60

MANICO | HANDLE  
Alluminio anodizzato verde militare  
Military green anodized aluminium

CLIP  
Sagomata in AISI 420 lucido  
Polished shaped AISI 420

RIVETTI | RIVETS  
AISI 303 lucido  
Polished AISI 303

5,5 cm - 2.16"

2 mm - 0.07"

13,5 cm - 5.31"

30 g - 1.06 oz



### FX-VPGP130 OR

SLIP JOINT

NEW  
ITEM

LAMA | BLADE  
N690Co lucida  
Polished N690Co  
HRC 58-60

MANICO | HANDLE  
Alluminio anodizzato arancione  
Orange anodized aluminium

CLIP  
Sagomata in AISI 420 lucido  
Polished shaped AISI 420

RIVETTI | RIVETS  
AISI 303 lucido  
Polished AISI 303

5,5 cm - 2.16"

2 mm - 0.07"

13,5 cm - 5.31"

30 g - 1.06 oz



# VULPIS GRENADE PATTERN TOOLS

MULTIPURPOSE

**FX-VPGPW-130-F3 TI**  
SLIP JOINT

NEW  
ITEM

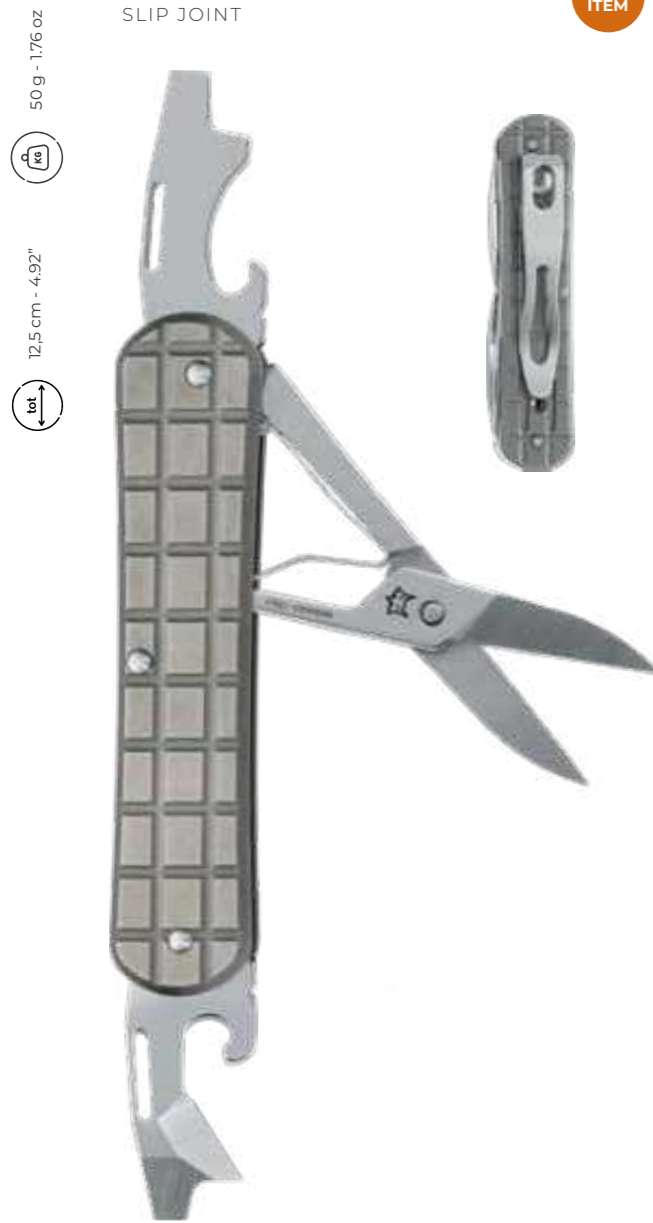

**FX-VPGPW-130-F3 BK**  
SLIP JOINT

NEW  
ITEM

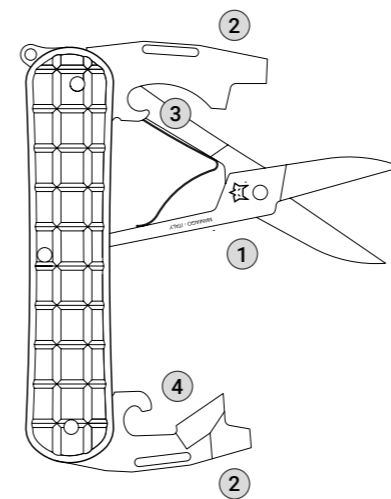

- 1 Forbici  
Scissors
- 2 Cacciavite a testa piatta  
Flathead screwdriver
- 3 Apribottiglie  
Bottle opener
- 4 Apriscatole  
Can opener



**FX-VPGPW-130-F3 MG**  
SLIP JOINT

NEW  
ITEM



**FX-VPGPW-130-F3 R**  
SLIP JOINT

NEW  
ITEM



**FX-VPGPW-130-F3 OR**  
SLIP JOINT

NEW  
ITEM



AISI 420 lucido  
Polished AISI 420

Titanio sabbiato  
Sandblasted titanium

Sagomata in AISI 420 lucido  
Polished shape AISI 420

AISI 303 lucido  
Polished AISI 303

AISI 420 lucido  
Polished AISI 420

Alluminio anodizzato nero  
Black anodized aluminium

Sagomata in AISI 420 lucido  
Polished shape AISI 420

AISI 303 lucido  
Polished AISI 303

AISI 420 lucido  
Polished AISI 420

Alluminio anodizzato verde militare  
Military green anodized aluminium

Sagomata in AISI 420 lucido  
Polished shape AISI 420

AISI 303 lucido  
Polished AISI 303

AISI 420 lucido  
Polished AISI 420

Alluminio anodizzato rosso  
Red anodized aluminium

Sagomata in AISI 420 lucido  
Polished shape AISI 420

AISI 303 lucido  
Polished AISI 303

AISI 420 lucido  
Polished AISI 420

Alluminio anodizzato arancione  
Orange anodized aluminium

Sagomata in AISI 420 lucido  
Polished shape AISI 420

AISI 303 lucido  
Polished AISI 303

# VULPIS

## OTTONE | BRASS

KNIFE VERSION



### FX-VP108 OT

SLIP JOINT

**LAMA | BLADE**  
M390 lucido  
Polished M390  
HRC 59-61

**MANICO | HANDLE**  
Ottone  
Brass

**RIVETTI | RIVETS**  
AISI 303 lucido  
Polished AISI 303

4,5 cm - 4.33" 2 mm - 0.07"

11 cm - 4.33" 45 g - 1.58 oz



### FX-VP130 OT

SLIP JOINT

**LAMA | BLADE**  
M390 lucido  
Polished M390  
HRC 59-61

**MANICO | HANDLE**  
Ottone  
Brass

**RIVETTI | RIVETS**  
AISI 303 lucido  
Polished AISI 303

5,5 cm - 2.16" 2 mm - 0.07"

13,5 cm - 5.31" 55 g - 1.94 oz



### FX-VP108 OTB

SLIP JOINT

**LAMA | BLADE**  
M390 Top Shield® nero  
Black Top Shield® M390  
HRC 59-61

**MANICO | HANDLE**  
Ottone  
Brass

**RIVETTI | RIVETS**  
AISI 303 lucido  
Polished AISI 303

4,5 cm - 4.33" 2 mm - 0.07"

11 cm - 4.33" 45 g - 1.58 oz



### FX-VP130 OTB

SLIP JOINT

**LAMA | BLADE**  
M390 Top Shield® nero  
Black Top Shield® M390  
HRC 59-61

**MANICO | HANDLE**  
Ottone  
Brass

**RIVETTI | RIVETS**  
AISI 303 lucido  
Polished AISI 303

5,5 cm - 2.16" 2 mm - 0.07"

13,5 cm - 5.31" 55 g - 1.94 oz

# VULPIS

## MULTIUSO | MULTIPURPOSE

WINNER 23  
EUROPEAN  
PRODUCT  
DESIGN  
AWARD

### SEI VARIANTI DI COLORE SIX COLOR VARIANTS

Titanio sabbato  
Sandblasted titanium

Fibra di carbonio 3K  
3K carbon fiber

Alluminio anodizzato nero  
Black anodized aluminium

Alluminio anodizzato arancione  
Orange anodized aluminium

Alluminio anodizzato verde  
Green anodized aluminium

Alluminio anodizzato azzurro  
Sky blue anodized aluminium



Espositore multiplo universale  
Universal multiple display



Espositore singolo universale  
Universal single display

Lama  
Blade

Apribottiglie  
Bottle opener

Apriscatole  
Can opener

Cacciavite a testa piatta  
Flathead screwdriver

Seghetto  
Hacksaw

Forbici  
Scissors

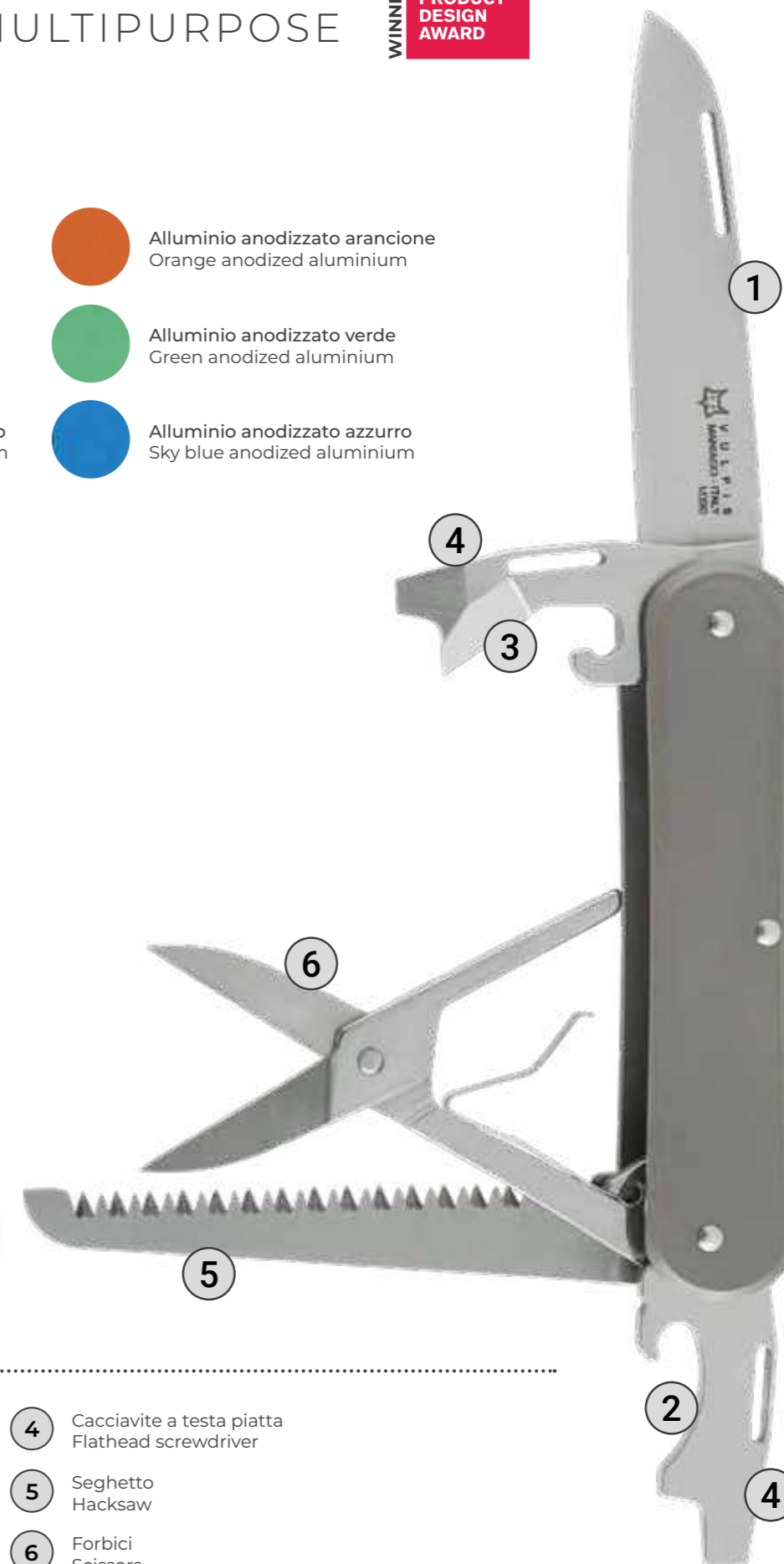

# VULPIS PREMIUM

## TITANIO SABBBIATO | SANDBLASTED TITANIUM

MULTIPURPOSE

### FX-VP108 TI

SLIP JOINT

29,5 g - 1,04 oz



11 cm - 4,33"



2 mm - 0,07"



4,5 cm - 1,77"



M390 lucido  
Polished M390  
HRC 59-61

Titanio sabbbiato  
Sandblasted titanium

AISI 303 lucido  
Polished AISI 303



### FX-VP130 TI

SLIP JOINT

35 g - 1,23 oz



13,5 cm - 5,31"



2 mm - 0,07"



5,5 cm - 2,16"



M390 lucido  
Polished M390  
HRC 59-61

Titanio sabbbiato  
Sandblasted titanium

AISI 303 lucido  
Polished AISI 303



### FX-VP130-3 TI

SLIP JOINT

LAMA | BLADE  
M390 lucido  
Polished M390  
HRC 59-61

MANICO | HANDLE  
Titanio sabbbiato  
Sandblasted titanium

RIVETTI | RIVETS  
AISI 303 lucido  
Polished AISI 303

5,5 cm - 2,16"

2 mm - 0,07"

13,5 cm - 5,31"

50,5 g - 1,78 oz



### FX-VP130-F4 TI

SLIP JOINT

LAMA | BLADE  
M390 lucido  
Polished M390  
HRC 59-61

MANICO | HANDLE  
Titanio sabbbiato  
Sandblasted titanium

RIVETTI | RIVETS  
AISI 303 lucido  
Polished AISI 303

5,5 cm - 2,16"

2 mm - 0,07"

13,5 cm - 5,31"

62,5 g - 2,20 oz



### FX-VP130-S4 TI

SLIP JOINT

LAMA | BLADE  
M390 lucido  
Polished M390  
HRC 59-61

MANICO | HANDLE  
Titanio sabbbiato  
Sandblasted titanium

RIVETTI | RIVETS  
AISI 303 lucido  
Polished AISI 303

5,5 cm - 2,16"

2 mm - 0,07"

13,5 cm - 5,31"

61,5 g - 2,16 oz



### FX-VP130-SF5 TI

SLIP JOINT

LAMA | BLADE  
M390 lucido  
Polished M390  
HRC 59-61

MANICO | HANDLE  
Titanio sabbbiato  
Sandblasted titanium

RIVETTI | RIVETS  
AISI 303 lucido  
Polished AISI 303

5,5 cm - 2,16"

2 mm - 0,07"

13,5 cm - 5,31"

71,5 g - 2,52 oz



# VULPIS PREMIUM

## FIBRA DI CARBONIO | CARBON FIBER

MULTIPURPOSE

### FX-VP108 CF

SLIP JOINT

17,5 g - 1,61 oz



11 cm - 4.33"



2 mm - 0.07"



4,5 cm - 1.77"



M390 lucido  
Polished M390  
HRC 59-61



Fibra di carbonio 3K  
3K carbon fiber



AISI 303 lucido  
Polished AISI 303



### FX-VP130 CF

SLIP JOINT

21 g - 0,74 oz



13,5 cm - 5.31"



2 mm - 0.07"



5,5 cm - 2.16"



M390 lucido  
Polished M390  
HRC 59-61



Fibra di carbonio 3K  
3K carbon fiber



AISI 303 lucido  
Polished AISI 303



### FX-VP130-3 CF

SLIP JOINT

**LAMA | BLADE**  
M390 lucido  
Polished M390  
HRC 59-61

**MANICO | HANDLE**  
Fibra di carbonio 3K  
3K carbon fiber

**RIVETTI | RIVETS**  
AISI 303 lucido  
Polished AISI 303



5,5 cm - 2.16"

2 mm - 0.07"



13,5 cm - 5.31"



36 g - 1,27 oz



### FX-VP130-F4 CF

SLIP JOINT

**LAMA | BLADE**  
M390 lucido  
Polished M390  
HRC 59-61

**MANICO | HANDLE**  
Fibra di carbonio 3K  
3K carbon fiber

**RIVETTI | RIVETS**  
AISI 303 lucido  
Polished AISI 303



5,5 cm - 2.16"



2 mm - 0.07"



13,5 cm - 5.31"



48 g - 1,69 oz



### FX-VP130-S4 CF

SLIP JOINT

**LAMA | BLADE**  
M390 lucido  
Polished M390  
HRC 59-61

**MANICO | HANDLE**  
Fibra di carbonio 3K  
3K carbon fiber

**RIVETTI | RIVETS**  
AISI 303 lucido  
Polished AISI 303



5,5 cm - 2.16"



2 mm - 0.07"



13,5 cm - 5.31"



47 g - 1,66 oz



### FX-VP130-SF5 CF

SLIP JOINT

**LAMA | BLADE**  
M390 lucido  
Polished M390  
HRC 59-61

**MANICO | HANDLE**  
Fibra di carbonio 3K  
3K carbon fiber

**RIVETTI | RIVETS**  
AISI 303 lucido  
Polished AISI 303



5,5 cm - 2.16"



2 mm - 0.07"



13,5 cm - 5.31"



50 g - 1,76 oz



# VULPIS

## ALLUMINIO | ALUMINIUM

MULTIPURPOSE

### FX-VP108 BK

SLIP JOINT

22 g - 0.77 oz



11 cm - 4.33"



2 mm - 0.07"



4,5 cm - 1.77"



N690Co lucido  
Polished N690Co  
HRC 58-60



Alluminio anodizzato nero  
Black anodized aluminium



AISI 303 lucido  
Polished AISI 303



### FX-VP130 BK

SLIP JOINT

26,5 g - 0.93 oz



13,5 cm - 5.31"



2 mm - 0.07"



5,5 cm - 2.16"



N690Co lucido  
Polished N690Co  
HRC 58-60



Alluminio anodizzato nero  
Black anodized aluminium



AISI 303 lucido  
Polished AISI 303



### FX-VP130-3 BK

SLIP JOINT

**LAMA | BLADE**  
N690Co lucido  
Polished N690Co  
HRC 58-60

**MANICO | HANDLE**  
Alluminio anodizzato nero  
Black anodized aluminium

**RIVETTI | RIVETS**  
AISI 303 lucido  
Polished AISI 303



5,5 cm - 2.16"



2 mm - 0.07"



13,5 cm - 5.31"



40,5 g - 1.42 oz



### FX-VP130-F4 BK

SLIP JOINT

**LAMA | BLADE**  
N690Co lucido  
Polished N690Co  
HRC 58-60

**MANICO | HANDLE**  
Alluminio anodizzato nero  
Black anodized aluminium

**RIVETTI | RIVETS**  
AISI 303 lucido  
Polished AISI 303



5,5 cm - 2.16"



2 mm - 0.07"



13,5 cm - 5.31"



52 g - 1.83 oz



### FX-VP130-S4 BK

SLIP JOINT

**LAMA | BLADE**  
N690Co lucido  
Polished N690Co  
HRC 58-60

**MANICO | HANDLE**  
Alluminio anodizzato nero  
Black anodized aluminium

**RIVETTI | RIVETS**  
AISI 303 lucido  
Polished AISI 303



5,5 cm - 2.16"



2 mm - 0.07"



13,5 cm - 5.31"



51 g - 1.79 oz



### FX-VP130-SF5 BK

SLIP JOINT

**LAMA | BLADE**  
N690Co lucido  
Polished N690Co  
HRC 58-60

**MANICO | HANDLE**  
Alluminio anodizzato nero  
Black anodized aluminium

**RIVETTI | RIVETS**  
AISI 303 lucido  
Polished AISI 303



5,5 cm - 2.16"



2 mm - 0.07"



13,5 cm - 5.31"



63 g - 2.22 oz



# VULPIS

## ALLUMINIO | ALUMINIUM

MULTIPURPOSE

### FX-VP108 SB

SLIP JOINT

22 g - 0.77 oz



11 cm - 4.33"



2 mm - 0.07"



4,5 cm - 1.77"



N690Co lucido  
Polished N690Co  
HRC 58-60



Alluminio anodizzato blu  
Blue anodized aluminium



AISI 303 lucido  
Polished AISI 303



### FX-VP130 SB

SLIP JOINT

26,5 g - 0.93 oz



13,5 cm - 5.31"



2 mm - 0.07"



5,5 cm - 2.16"



N690Co lucido  
Polished N690Co  
HRC 58-60



Alluminio anodizzato blu  
Blue anodized aluminium



AISI 303 lucido  
Polished AISI 303



### FX-VP130-3 SB

SLIP JOINT

**LAMA | BLADE**  
N690Co lucido  
Polished N690Co  
HRC 58-60

**MANICO | HANDLE**  
Alluminio anodizzato blu  
Blue anodized aluminium

**RIVETTI | RIVETS**  
AISI 303 lucido  
Polished AISI 303



5,5 cm - 2.16"



2 mm - 0.07"



13,5 cm - 5.31"



40,5 g - 1.42 oz



### FX-VP130-F4 SB

SLIP JOINT

**LAMA | BLADE**  
N690Co lucido  
Polished N690Co  
HRC 58-60

**MANICO | HANDLE**  
Alluminio anodizzato blu  
Blue anodized aluminium

**RIVETTI | RIVETS**  
AISI 303 lucido  
Polished AISI 303



5,5 cm - 2.16"



2 mm - 0.07"



13,5 cm - 5.31"



52 g - 1.83 oz

### FX-VP130-S4 SB

SLIP JOINT

**LAMA | BLADE**  
N690Co lucido  
Polished N690Co  
HRC 58-60

**MANICO | HANDLE**  
Alluminio anodizzato blu  
Blue anodized aluminium

**RIVETTI | RIVETS**  
AISI 303 lucido  
Polished AISI 303



5,5 cm - 2.16"



2 mm - 0.07"



13,5 cm - 5.31"



51 g - 1.79 oz



### FX-VP130-SF5 SB

SLIP JOINT

**LAMA | BLADE**  
N690Co lucido  
Polished N690Co  
HRC 58-60

**MANICO | HANDLE**  
Alluminio anodizzato blu  
Blue anodized aluminium

**RIVETTI | RIVETS**  
AISI 303 lucido  
Polished AISI 303



5,5 cm - 2.16"



2 mm - 0.07"



13,5 cm - 5.31"



63 g - 2.22 oz

# VULPIS

## ALLUMINIO | ALUMINIUM

MULTIPURPOSE

### FX-VP108 OD

SLIP JOINT

22 g - 0,77 oz



11 cm - 4,33"



2 mm - 0,07"



4,5 cm - 1,77"



N690Co lucido  
Polished N690Co  
HRC 58-60



Alluminio anodizzato verde OD  
OD green anodized aluminium



AISI 303 lucido  
Polished AISI 303



### FX-VP130 OD

SLIP JOINT

26,5 g - 0,93 oz



13,5 cm - 5,31"



2 mm - 0,07"



5,5 cm - 2,16"



N690Co lucido  
Polished N690Co  
HRC 58-60



Alluminio anodizzato verde OD  
OD green anodized aluminium



AISI 303 lucido  
Polished AISI 303



### FX-VP130-3 OD

SLIP JOINT

**LAMA | BLADE**  
N690Co lucido  
Polished N690Co  
HRC 58-60

**MANICO | HANDLE**  
Alluminio anodizzato verde OD  
OD green anodized aluminium

**RIVETTI | RIVETS**  
AISI 303 lucido  
Polished AISI 303



5,5 cm - 2,16"



2 mm - 0,07"



13,5 cm - 5,31"



40,5 g - 1,42 oz



### FX-VP130-F4 OD

SLIP JOINT

**LAMA | BLADE**  
N690Co lucido  
Polished N690Co  
HRC 58-60

**MANICO | HANDLE**  
Alluminio anodizzato verde OD  
OD green anodized aluminium

**RIVETTI | RIVETS**  
AISI 303 lucido  
Polished AISI 303



5,5 cm - 2,16"



2 mm - 0,07"



13,5 cm - 5,31"



52 g - 1,83 oz



### FX-VP130-S4 OD

SLIP JOINT

**LAMA | BLADE**  
N690Co lucido  
Polished N690Co  
HRC 58-60

**MANICO | HANDLE**  
Alluminio anodizzato verde OD  
OD green anodized aluminium

**RIVETTI | RIVETS**  
AISI 303 lucido  
Polished AISI 303



5,5 cm - 2,16"

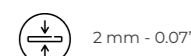

2 mm - 0,07"



13,5 cm - 5,31"



51 g - 1,79 oz



### FX-VP130-SF5 OD

SLIP JOINT

**LAMA | BLADE**  
N690Co lucido  
Polished N690Co  
HRC 58-60

**MANICO | HANDLE**  
Alluminio anodizzato verde OD  
OD green anodized aluminium

**RIVETTI | RIVETS**  
AISI 303 lucido  
Polished AISI 303



5,5 cm - 2,16"

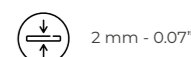

2 mm - 0,07"



13,5 cm - 5,31"



63 g - 2,22 oz



# VULPIS

## ALLUMINIO | ALUMINIUM

MULTIPURPOSE

### FX-VP108 OR

SLIP JOINT

22 g - 0.77 oz



11 cm - 4.33"



2 mm - 0.07"



4,5 cm - 1.77"



N690Co lucido  
Polished N690Co  
HRC 58-60



Alluminio anodizzato arancione  
Orange anodized aluminium



AISI 303 lucido  
Polished AISI 303



### FX-VP130 OR

SLIP JOINT

26,5 g - 0.93 oz



13,5 cm - 5.31"



2 mm - 0.07"



5,5 cm - 2.16"



N690Co lucido  
Polished N690Co  
HRC 58-60



Alluminio anodizzato arancione  
Orange anodized aluminium



AISI 303 lucido  
Polished AISI 303



### FX-VP130-3 OR

SLIP JOINT

**LAMA | BLADE**  
N690Co lucido  
Polished N690Co  
HRC 58-60

**MANICO | HANDLE**  
Alluminio anodizzato arancione  
Orange anodized aluminium

**RIVETTI | RIVETS**  
AISI 303 lucido  
Polished AISI 303



5,5 cm - 2.16"



2 mm - 0.07"



13,5 cm - 5.31"



40,5 g - 1.42 oz



### FX-VP130-F4 OR

SLIP JOINT

**LAMA | BLADE**  
N690Co lucido  
Polished N690Co  
HRC 58-60

**MANICO | HANDLE**  
Alluminio anodizzato arancione  
Orange anodized aluminium

**RIVETTI | RIVETS**  
AISI 303 lucido  
Polished AISI 303



5,5 cm - 2.16"



2 mm - 0.07"



13,5 cm - 5.31"



52 g - 1.83 oz



### FX-VP130-S4 OR

SLIP JOINT

**LAMA | BLADE**  
N690Co lucido  
Polished N690Co  
HRC 58-60

**MANICO | HANDLE**  
Alluminio anodizzato arancione  
Orange anodized aluminium

**RIVETTI | RIVETS**  
AISI 303 lucido  
Polished AISI 303



5,5 cm - 2.16"



2 mm - 0.07"



13,5 cm - 5.31"



51 g - 1.79 oz



### FX-VP130-SF5 OR

SLIP JOINT

**LAMA | BLADE**  
N690Co lucido  
Polished N690Co  
HRC 58-60

**MANICO | HANDLE**  
Alluminio anodizzato arancione  
Orange anodized aluminium

**RIVETTI | RIVETS**  
AISI 303 lucido  
Polished AISI 303



5,5 cm - 2.16"



2 mm - 0.07"



13,5 cm - 5.31"



63 g - 2.22 oz



# 226 FOX VENATORES

**LAMA | BLADE**  
M390 lucido  
Polished M390  
HRC 59-61

**MANICO | HANDLE**  
Corno di cervo  
Deer horn

**RIVETTI | RIVETS**  
Ottone  
Brass

Aperto / Open: 17,2 cm - 6.77" | Chiuso / Closed: 10 cm - 3.94"



Fodero in cuoio marrone per i codici:  
226/6 CE, 226/7 CE, 226/7 SCE  
Brown leather sheath for codes:  
226/6 CE, 226/7 CE, 226/7 SCE



Fodero in cuoio marrone per il codice:  
226/8 SCE  
Brown leather sheath for code:  
226/8 SCE

## 226/6 CE SLIP JOINT

 100 g - 3.53

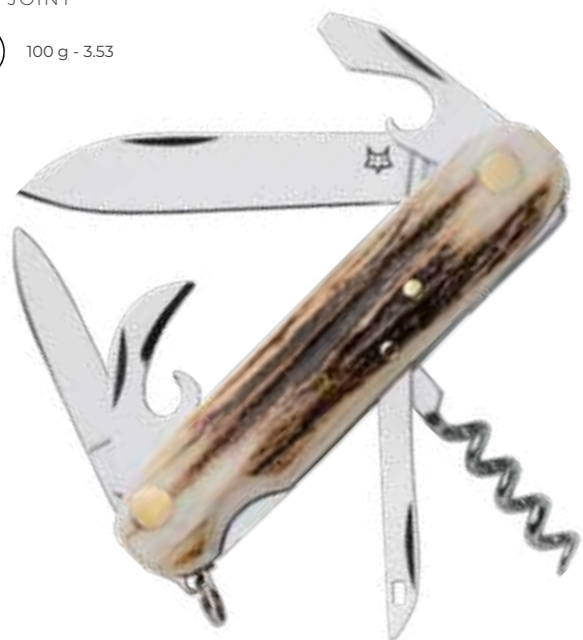

## 226/7 CE SLIP JOINT

 110 g - 3.88 oz



## 226/7 SCE SLIP JOINT

 135 g - 4.76 oz



## 226/8 SCE SLIP JOINT

 155 g - 5.47 oz



# FX-409 SPORA

designed by Raven Knives Design

Il coltello per cogliere funghi Fox Spora è stato ideato proprio per affrontare la delicatezza dei gambi dei funghi, facilitando così il processo di raccolta. Con la sua lama appositamente progettata, consente un taglio preciso dei gambi senza danneggiare il micelio, le delicate fibre simili a radici da cui può svilupparsi un nuovo fungo. Inoltre, la presenza di una spazzola richiudibile permette di pulire facilmente il fungo dai detriti prima di conservarlo. Il design accattivante e la clip per il trasporto rendono il coltello pratico e sempre pronto all'uso durante le escursioni fungine.

The Fox Spora mushroom knife is designed to address the delicate stems of mushrooms, thus facilitating the harvesting process. With its specially designed blade, it allows for precise cutting of the stems without damaging the mycelium, the delicate root-like fibers from which a new mushroom can develop. Additionally, the inclusion of a foldable brush enables easy removal of debris from the mushroom before storage. Its appealing design and pocket clip make the knife practical and always ready for use during mushroom forays.



**FX-409 OL**  
LINER LOCK



100 g - 3.53



17.5 cm - 6.89"



3 mm - 0.12"



6.5 cm - 2.56"

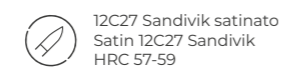

12C27 Sandvik satinato  
Satin 12C27 Sandvik  
HRC 57-59



Ulivo  
Olive wood



AISI 420 burattato  
Tumbled AISI 420



AISI 303 lucido  
Polished AISI 303



Sagomata in AISI 420 burattato  
Tumbled shaped AISI 420



AISI 303 lucido  
Polished AISI 303



**FX-409**  
LINER LOCK



100 g - 3.53



17.5 cm - 6.89"



3 mm - 0.12"



6.5 cm - 2.56"

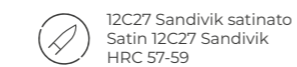

12C27 Sandvik satinato  
Satin 12C27 Sandvik  
HRC 57-59



Eucalipto  
Eucalyptus wood



AISI 420 burattato  
Tumbled AISI 420



AISI 303 lucido  
Polished AISI 303



Sagomata in AISI 420 burattato  
Tumbled shaped AISI 420



AISI 303 lucido  
Polished AISI 303

# 408

## COLTELLO DA FUNGHI - MUSHROOMS KNIFE

Il coltello per cogliere funghi è stato ideato proprio per affrontare la delicatezza dei gambi dei funghi, facilitando così il processo di raccolta. Con la sua lama appositamente progettata, consente un taglio preciso dei gambi senza danneggiare il micelio, le delicate fibre simili a radici da cui può svilupparsi un nuovo fungo. Inoltre, la presenza di una spazzola richiudibile permette di pulire facilmente il fungo dai detriti prima di conservarlo. Il design accattivante e la catenella per il trasporto rendono il coltello pratico e sempre pronto all'uso durante le escursioni fungine.

The mushroom harvesting knife is specifically designed to address the delicacy of mushroom stems, thereby facilitating the harvesting process. With its specially designed blade, it enables precise cutting of the stems without damaging the mycelium, the delicate root-like fibers from which a new mushroom can develop. Additionally, the presence of a foldable brush allows for easy cleaning of the mushroom from debris before storage. The appealing design and the chain for transportation make the knife practical and always ready for use during mushroom forays.



**408**  
LINER LOCK



100 g - 3.53



18 cm - 7.08"



3 mm - 0.12"



7 cm - 2.46"



AISI 440 satinato  
Satin AISI 440  
HRC 57-59



Palissandro  
Palisander wood



AISI 420 lucido  
Polished AISI 420



Sagomata in AISI 420 burattato  
Tumbled shaped AISI 420



AISI 303 lucido  
Polished AISI 303

**408 G10**  
LINER LOCK



100 g - 3.53



18 cm - 7.08"



3 mm - 0.12"



7 cm - 2.46"

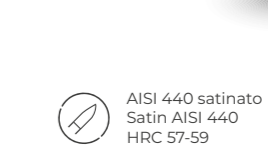

AISI 440 satinato  
Satin AISI 440  
HRC 57-59



G10 nero  
Black G10



AISI 420 lucido  
Polished AISI 420



Sagomata in AISI 420 burattato  
Tumbled shaped AISI 420



AISI 303 lucido  
Polished AISI 303



**405 OL**  
SLIP JOINT

**LAMA | BLADE**  
AISI 420 satinato  
Satin AISI 420  
HRC 54-56

**MANICO | HANDLE**  
Ulivo  
Olive wood

**RIVETTI | RIVETS**  
Ottone lucido  
Polished brass

|  |               |  |                |
|--|---------------|--|----------------|
|  | 7 cm - 2.46"  |  | 3 mm - 0.12"   |
|  | 18 cm - 7.08" |  | 70 g - 2.46 oz |



**405**  
SLIP JOINT

**LAMA | BLADE**  
AISI 420 satinato  
Satin AISI 420  
HRC 54-56

**MANICO | HANDLE**  
Palissandro  
Palisander wood

**RIVETTI | RIVETS**  
Ottone lucido  
Polished brass

|  |               |  |                |
|--|---------------|--|----------------|
|  | 7 cm - 2.46"  |  | 3 mm - 0.12"   |
|  | 18 cm - 7.08" |  | 70 g - 2.46 oz |



**403**  
SLIP JOINT

**LAMA | BLADE**  
AISI 420 satinato  
Satin AISI 420  
HRC 54-56

**MANICO | HANDLE**  
Palissandro  
Palisander wood

**RIVETTI | RIVETS**  
Ottone lucido  
Polished brass

|  |               |  |                 |
|--|---------------|--|-----------------|
|  | 7 cm - 2.46"  |  | 3 mm - 0.12"    |
|  | 18 cm - 7.08" |  | 120 g - 4.23 oz |



**404**  
SLIP JOINT

**LAMA | BLADE**  
AISI 420 satinato  
Satin AISI 420  
HRC 54-56

**MANICO | HANDLE**  
Palissandro  
Palisander wood

**RIVETTI | RIVETS**  
Ottone lucido  
Polished brass

|  |               |  |                 |
|--|---------------|--|-----------------|
|  | 7 cm - 2.46"  |  | 3 mm - 0.12"    |
|  | 18 cm - 7.08" |  | 120 g - 4.23 oz |

**406 B**  
SLIP JOINT

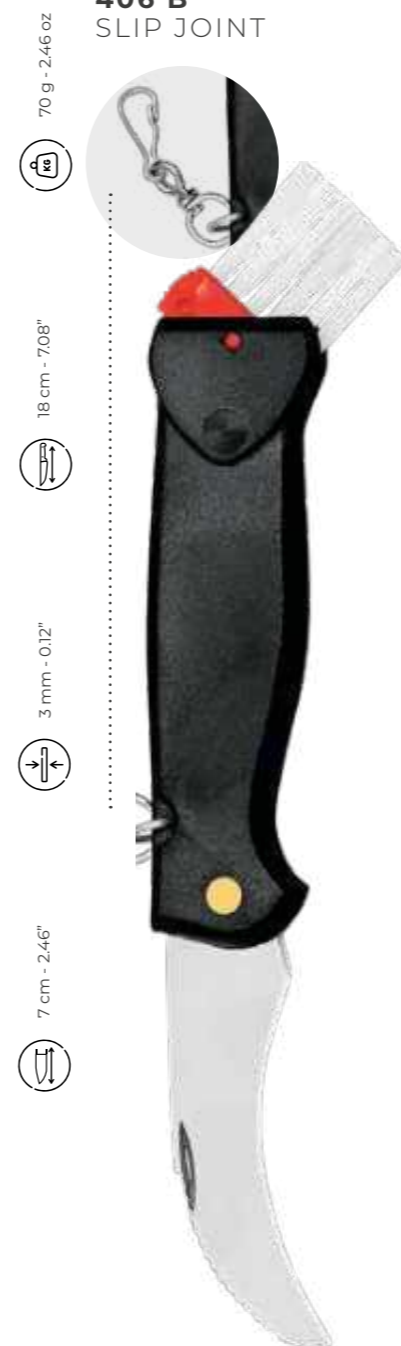

|  |                |
|--|----------------|
|  | 70 g - 2.46 oz |
|  | 18 cm - 7.08"  |
|  | 3 mm - 0.12"   |
|  | 7 cm - 2.46"   |

- AISI 420 satinato  
Satin AISI 420  
HRC 54-56
- ABS nero  
Black ABS
- Ottone lucido  
Polished brass

**406 R**  
SLIP JOINT



|  |                |
|--|----------------|
|  | 70 g - 2.46 oz |
|  | 18 cm - 7.08"  |
|  | 3 mm - 0.12"   |
|  | 7 cm - 2.46"   |

- AISI 420 satinato  
Satin AISI 420  
HRC 54-56
- ABS rosso  
Red ABS
- Ottone lucido  
Polished brass

**406 Y**  
SLIP JOINT



|  |                |
|--|----------------|
|  | 70 g - 2.46 oz |
|  | 18 cm - 7.08"  |
|  | 3 mm - 0.12"   |
|  | 7 cm - 2.46"   |

- AISI 420 satinato  
Satin AISI 420  
HRC 54-56
- ABS giallo  
Yellow ABS
- Ottone lucido  
Polished brass



**2C 205/E P B**  
 SLIP JOINT

**LAMA | BLADE**  
 Acciaio al carbonio  
 Carbon steel  
 HRC 54-56

**MANICO | HANDLE**  
 Plastica nera  
 Black plastic

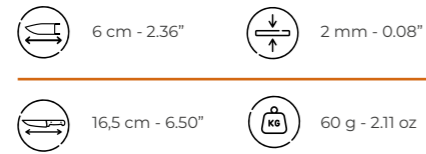

**2C 210/17 B**  
 SLIP JOINT

**LAMA | BLADE**  
 Acciaio al carbonio C70  
 Carbon steel C70  
 HRC 58-60

**MANICO | HANDLE**  
 Nylon® nero  
 Black Nylon®

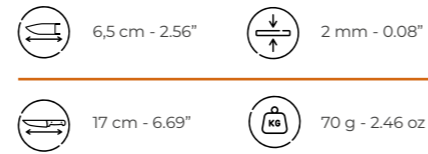

**2C 223 B**  
 SLIP JOINT

**LAMA | BLADE**  
 Acciaio al carbonio  
 Carbon steel  
 HRC 54-56

**MANICO | HANDLE**  
 Plastica nera  
 Black plastic

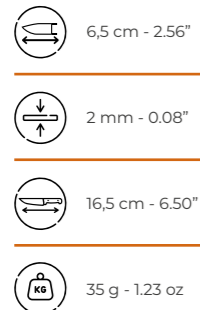

**2C 225 B**  
 SLIP JOINT

**LAMA | BLADE**  
 Acciaio al carbonio  
 Carbon steel  
 HRC 54-56

**MANICO | HANDLE**  
 Plastica nera  
 Black plastic



**2C 206/E B**  
 SLIP JOINT

**LAMA | BLADE**  
 Acciaio al carbonio C70  
 Carbon steel C70  
 HRC 58-60

**MANICO | HANDLE**  
 Ciliegio  
 Cherry wood

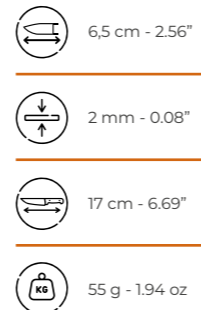

**2C 211/17 B**  
 SLIP JOINT

**LAMA | BLADE**  
 Acciaio al carbonio C70  
 Carbon steel C70  
 HRC 58-60

**MANICO | HANDLE**  
 Ciliegio  
 Cherry wood

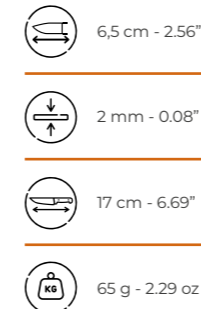

**2C 239/LE B**  
 SLIP JOINT

**LAMA | BLADE**  
 Acciaio al carbonio  
 Carbon steel  
 HRC 54-56

**MANICO | HANDLE**  
 Ciliegio  
 Cherry wood

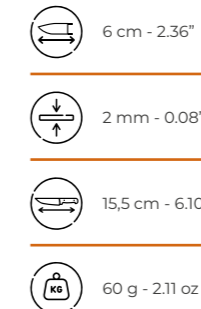

**369/15 B**  
 SLIP JOINT

**LAMA | BLADE**  
 Acciaio al carbonio C70  
 Carbon steel C70  
 HRC 58-60

**MANICO | HANDLE**  
 Ciliegio  
 Cherry wood



**369/17 B**  
 SLIP JOINT

**LAMA | BLADE**  
 Acciaio al carbonio C70  
 Carbon steel C70  
 HRC 58-60

**MANICO | HANDLE**  
 Ciliegio  
 Cherry wood

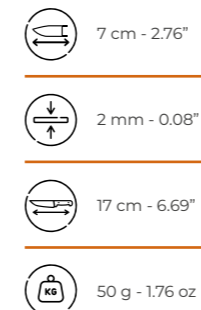

**369/19 B**  
 SLIP JOINT

**LAMA | BLADE**  
 Acciaio al carbonio C70  
 Carbon steel C70  
 HRC 58-60

**MANICO | HANDLE**  
 Ciliegio  
 Cherry wood

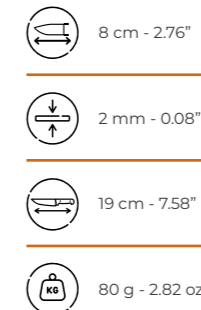

**2C 242/E B**  
 SLIP JOINT

**LAMA | BLADE**  
 Acciaio al carbonio  
 Carbon steel  
 HRC 54-56

**MANICO | HANDLE**  
 Ciliegio  
 Cherry wood



# AGRICOLTURA | AGRICULTURE

## INNESTO - GRAFTING



**356/16 B**  
FIXED BLADE

**LAMA | BLADE**  
Acciaio al carbonio  
Carbon steel  
HRC 54-56

**MANICO | HANDLE**  
Plastica (imitazione legno)  
Plastic (wood imitation)

|  |               |  |                |
|--|---------------|--|----------------|
|  | 7 cm - 2.76"  |  | 2 mm - 0.08"   |
|  | 16 cm - 6.30" |  | 50 g - 1.76 oz |



**356/20**  
FIXED BLADE

**LAMA | BLADE**  
Acciaio al carbonio  
Carbon steel  
HRC 54-56

**MANICO | HANDLE**  
Plastica (imitazione legno)  
Plastic (wood imitation)

|  |               |  |                |
|--|---------------|--|----------------|
|  | 9 cm - 3.54"  |  | 2 mm - 0.08"   |
|  | 20 cm - 7.87" |  | 90 g - 3.17 oz |



**343/20**  
SLIP JOINT

**LAMA | BLADE**  
AISI 420C  
HRC 54-56

**MANICO | HANDLE**  
Palissandro  
Palissander wood

|  |                 |
|--|-----------------|
|  | 9 cm - 3.54"    |
|  | 2 mm - 0.08"    |
|  | 20 cm - 7.87"   |
|  | 135 g - 4.76 oz |



**2C 242/18 B**  
SLIP JOINT

**LAMA | BLADE**  
N690Co  
HRC 58-60

**MANICO | HANDLE**  
Ciliegio  
Cherry wood

|  |                 |
|--|-----------------|
|  | 8 cm - 3.15"    |
|  | 3 mm - 0.12"    |
|  | 18 cm - 7.09"   |
|  | 110 g - 3.88 oz |



**369/13 B**  
SLIP JOINT

**LAMA | BLADE**  
AISI 420C  
HRC 54-56

**MANICO | HANDLE**  
Plastica rossa  
Red plastic

|  |                |
|--|----------------|
|  | 5 cm - 1.97"   |
|  | 1,5 mm - 0.05" |
|  | 13 cm - 5.12"  |
|  | 25 g - 0.88 oz |

# AGRICOLTURA | AGRICULTURE

## COLTELLI DA GIARDINO - GARDENING KNIVES



**300/18 B**  
SLIP JOINT

**LAMA | BLADE**  
AISI 420C  
HRC 54-56

**MANICO | HANDLE**  
Palissandro  
Palissander wood

|  |                 |
|--|-----------------|
|  | 8 cm - 3.15"    |
|  | 2,5 mm - 0.10"  |
|  | 18,5 cm - 7.28" |
|  | 60 g - 2.12 oz  |



**301/18 B**  
SLIP JOINT

**LAMA | BLADE**  
AISI 420C  
HRC 54-56

**MANICO | HANDLE**  
Palissandro  
Palissander wood

|  |                |
|--|----------------|
|  | 8,5 cm - 3.35" |
|  | 2,5 mm - 0.10" |
|  | 18 cm - 7.09"  |
|  | 65 g - 2.29 oz |



**2C 203/16 B**  
SLIP JOINT

**LAMA | BLADE**  
AISI 420C  
HRC 54-56

**MANICO | HANDLE**  
Nylon® verde  
Green Nylon®

|  |                |
|--|----------------|
|  | 7 cm - 2.76"   |
|  | 2 mm - 0.08"   |
|  | 16 cm - 6.30"  |
|  | 45 g - 1.59 oz |



**2C 204/19 B**  
SLIP JOINT

**LAMA | BLADE**  
AISI 420C  
HRC 54-56

**MANICO | HANDLE**  
Nylon® blu  
Blue Nylon®

|  |                |
|--|----------------|
|  | 8,5 cm - 3.35" |
|  | 2,5 mm - 0.10" |
|  | 19 cm - 7.48"  |
|  | 70 g - 2.47 oz |



**2C 205/20 B**  
SLIP JOINT

**LAMA | BLADE**  
AISI 420C  
HRC 54-56

**MANICO | HANDLE**  
Nylon® rosso  
Red Nylon®

|  |                 |
|--|-----------------|
|  | 8,5 cm - 3.35"  |
|  | 2,5 mm - 0.10"  |
|  | 19,5 cm - 7.67" |
|  | 75 g - 2.65 oz  |



**2C 220/19 B**  
SLIP JOINT

**LAMA | BLADE**  
AISI 420C  
HRC 54-56

**MANICO | HANDLE**  
Plastica nera  
Black plastic

|  |                |
|--|----------------|
|  | 8 cm - 3.15"   |
|  | 2,5 mm - 0.10" |
|  | 19 cm - 7.48"  |
|  | 75 g - 2.65 oz |



**2C 261/18**  
FIXED BLADE

**LAMA | BLADE**  
Acciaio al carbonio C60  
Carbon steel C60  
HRC 55-67

**MANICO | HANDLE**  
Cuoio  
Leather

18 cm - 7.09"

3,5 mm - 0.13"

30 cm - 11.81"

415 g - 14.64 oz



**2C 262/30**  
FIXED BLADE

**LAMA | BLADE**  
Acciaio al carbonio C60  
Carbon steel C60  
HRC 55-67

**MANICO | HANDLE**  
Cuoio  
Leather

30 cm - 11.81"

4 mm - 0.15"

43 cm - 16.92"

610 g - 21.51 oz



**2C 263/30**  
FIXED BLADE

**LAMA | BLADE**  
Acciaio al carbonio C60  
Carbon steel C60  
HRC 55-67

**MANICO | HANDLE**  
Cuoio  
Leather

30 cm - 11.81"

3,5 mm - 0.13"

44 cm - 17.32"

650 g - 22.92 oz



**2C 264/30**  
FIXED BLADE

**LAMA | BLADE**  
Acciaio al carbonio C60  
Carbon steel C60  
HRC 55-67

**MANICO | HANDLE**  
Cuoio  
Leather

30 cm - 11.81"

3 mm - 0.12"

41.5 cm - 16.33"

650 g - 22.92 oz



**FX-639 RD**  
FIXED BLADE

**LAMA | BLADE**  
AISI 420 satinato  
Satin AISI 420  
HRC 54-56

**MANICO | HANDLE**  
FRN® rosso  
Red FRN®

**CLIP**  
FRN® rosso  
Red FRN®

7 cm - 2.46"

1 mm - 0.03"

18,5 cm - 7.28"

60 g - 2.17 oz



**640 OD**  
FIXED BLADE

**LAMA | BLADE**  
AISI 420 satinato  
Satin AISI 420  
HRC 54-56

**MANICO | HANDLE**  
FRN® verde OD  
OD green FRN®

**CLIP**  
FRN® verde OD  
OD green FRN®

5,5 cm - 2.16"

1 mm - 0.03"

12,5 cm - 4.92"

55 g - 1.94 oz



**640/1**  
FIXED BLADE

**LAMA | BLADE**  
AISI 420 satinato  
Satin AISI 420  
HRC 54-56

**MANICO | HANDLE**  
FRN® rosso  
Red FRN®

**CLIP**  
FRN® rosso  
Red FRN®

5,5 cm - 2.16"

1 mm - 0.03"

12,5 cm - 4.92"

55 g - 1.94 oz



**640**  
FIXED BLADE

**LAMA | BLADE**  
AISI 420 satinato  
Satin AISI 420  
HRC 54-56

**MANICO | HANDLE**  
FRN® nero  
Black FRN®

**CLIP**  
FRN® nero  
Black FRN®

5,5 cm - 2.16"

1 mm - 0.03"

12,5 cm - 4.92"

55 g - 1.94 oz





## **TAGLIA SIGARI CIGAR CUTTERS**

Fox Knives apre le sue porte al mondo del sigaro proponendo diversi accessori da taglio realizzati con materiali di ottima qualità, rifiniti artigianalmente, dalle linee eleganti e sinuose. I taglia sigari Fox Knives sono la scelta per chi desidera completare un momento di piacere con un accessorio di classe.

Fox Knives opens the doors to the world of cigars by offering several cutting accessories made of the highest quality materials, handcrafted finish, and elegant and sinuous lines. Fox Knives cigar cutters are the choice for those who want to complete a moment of pleasure with a classy accessory.

# 747 FIGARO

designed by Anarcnide



Capacità di taglio  
Cutting capacity  
21 mm - 0.82"



## 747 DS

**CORPO | BODY**  
Super Dense Twist™  
by Damasteel®  
HRC 59-61

**VITI | SCREWS**  
AISI 303 lucido  
Polished AISI 303

7,6 cm - 2.99"

30 g - 1.05 oz

Il tagliasigari Figaro sembra un accessorio molto pratico per gli amanti dei sigari. La sua portabilità e la capacità di ottenere un taglio preciso nonostante le dimensioni ridotte lo rendono un compagno ideale per i momenti di relax. E il fatto che sia facilmente smontabile per l'affilatura e la manutenzione aggiunge un tocco di praticità che sicuramente sarà apprezzato dagli appassionati.

Despite its small size, the Figaro cigar cutter allows for a perfect cut and, thanks to its minimal weight, can be carried anywhere along with its leather sheath. The Figaro is easily disassembled to allow for impeccable sharpening and proper maintenance.



Scatola + fodero in cuoio rosso  
Box + red leather sheath

# 746 OTELLO

designed by BE.DI.MA

Otello è il tagliasigari ideale per soddisfare le esigenze degli appassionati: assicura un taglio netto, è compatto e offre facilità nel riaffilare le parti taglienti e nel smontaggio per le operazioni di pulizia e manutenzione. Il taglio preciso e pulito è garantito dal movimento scorrevole della lama, che non schiaccia il sigaro. Otello rappresenta la sintesi perfetta che unisce il meglio del Figaro (747) e del 749 in termini di dimensioni e capacità di taglio.

Otello is the ideal cigar cutter to meet enthusiasts' needs: it ensures a clean cut, is compact, and offers ease in sharpening the cutting parts and disassembly for cleaning and maintenance operations. The precise and clean cut is guaranteed by the smooth sliding movement of the blade, which does not crush the cigar. Otello represents the perfect synthesis that combines the best of Figaro (747) and 749 in terms of size and cutting capacity.



Capacità di taglio  
Cutting capacity  
22 mm - 0.86"



Cuoio nero  
Black leather

## 746 BSW

**CORPO | BODY**  
AISI 420C black idrogliider  
stone washed  
Black idrogliider stone  
washed AISI 420C  
HRC 54-56

**VITI | SCREWS**  
AISI 303 cromato  
Chrome plate AISI 303

8,2 cm - 3.22"

50 g - 1.76 oz



Capacità di taglio  
Cutting capacity  
21 mm - 0.82"



Cuoio nero  
Black leather

## 747 BSW

**CORPO | BODY**  
AISI 420C black idrogliider  
stone washed  
Black idrogliider stone  
washed AISI 420C  
HRC 54-56

**VITI | SCREWS**  
AISI 303 PVD dorato  
Golden PVD AISI 303

7,6 cm - 2.99"

30 g - 1.05 oz



Capacità di taglio  
Cutting capacity  
21 mm - 0.82"



Cuoio marrone  
Brown leather

## 747

**CORPO | BODY**  
AISI 420C sabbiato  
Sandblasted AISI 420C  
HRC 54-56

**VITI | SCREWS**  
AISI 303 lucido  
Polished AISI 303

7,6 cm - 2.99"

30 g - 1.05 oz



Capacità di taglio  
Cutting capacity  
22 mm - 0.86"



Cuoio marrone  
Brown leather

## 746

**CORPO | BODY**  
AISI 420C satinato  
Satin AISI 420C  
HRC 54-56

**VITI | SCREWS**  
AISI 303 cromato  
Chrome plate AISI 303

8,2 cm - 3.22"

50 g - 1.76 oz

749

TAGLIASIGARI SCORREVOLE - SLIDING CIGAR CUTTER

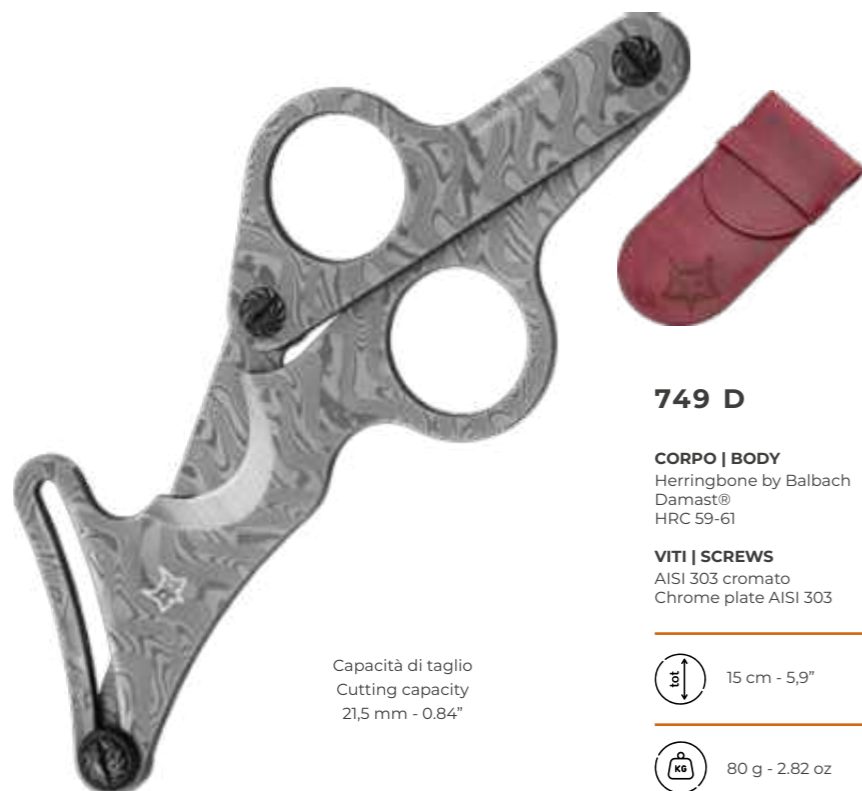

Capacità di taglio  
Cutting capacity  
21,5 mm - 0.84"

**749 D**

**CORPO | BODY**  
Herringbone by Balbach  
Damast®  
HRC 59-61

**VITI | SCREWS**  
AISI 303 cromato  
Chrome plate AISI 303

15 cm - 5,9"

80 g - 2.82 oz

Il tagliasigari scorrevole non solo offre un taglio impeccabile, ma anche un'esperienza di utilizzo fluida e senza intoppi. Le sue lunghe leve assicurano una distribuzione uniforme della forza di taglio, riducendo al minimo il rischio di danneggiare il sigaro. Inoltre, il sistema di smontaggio brevettato consente una manutenzione agevole, garantendo che il tagliasigari sia sempre pronto all'uso.

The sliding cigar cutter not only provides an impeccable cut but also ensures a smooth and hassle-free user experience. Its long levers ensure an even distribution of cutting force, minimizing the risk of damaging the cigar. Furthermore, the patented disassembly system allows for easy maintenance, ensuring that the cigar cutter is always ready for use.



Scatola + fodero in cuoio rosso  
Box + red leather sheath

749

Smoking Moses Razor Cut



Capacità di taglio  
Cutting capacity  
21,5 mm - 0.84"

**749 SM BSWF**

**CORPO | BODY**  
AISI 440A black  
idrogliider stone washed  
Black idrogliider stone  
washed AISI 440A  
HRC 54-56

**VITI | SCREWS**  
AISI 303 cromato  
Chrome plated AISI 303

15 cm - 5,9"

80 g - 2.82 oz



Cuoio marrone  
Brown leather



Capacità di taglio  
Cutting capacity  
21,5 mm - 0.84"

**749 SMF**

**CORPO | BODY**  
AISI 440A sabbato  
Sandblasted AISI 440A  
HRC 54-56

**VITI | SCREWS**  
AISI 303 cromato  
Chrome plated AISI 303

15 cm - 5,9"

80 g - 2.82 oz



Cuoio marrone  
Brown leather

749/1

TAGLIASIGARI SCORREVOLE - SLIDING CIGAR CUTTER

Il 749/1 è una raffinata combinazione del classico 749 con una pratica tavoletta in legno, dotata di un posacenere appositamente studiato per i sigari. Questo elegante accessorio completa perfettamente il 749, offrendo un'esperienza unica e lussuosa per gli amanti dei sigari. La tavoletta in legno, realizzata con materiali di alta qualità, aggiunge un tocco di classe e funzionalità, rendendo il 749/1 una scelta ideale per chi cerca eleganza e praticità in un unico prodotto.

749/1 is a refined combination of the classic 749 with a practical wooden board, equipped with an ashtray specially designed for cigars. This elegant accessory perfectly complements the 749, offering a unique and luxurious experience for cigar lovers. The wooden board, made from high-quality materials, adds a touch of class and functionality, making the 749/1 an ideal choice for those seeking elegance and practicality in one.



Capacità di taglio  
Cutting capacity  
22 mm - 0.86"

**749/1 SM BSW**

**CORPO | BODY**  
AISI 440A black  
idrogliider stone washed  
Black idrogliider stone  
washed AISI 440A  
HRC 54-56

**VITI | SCREWS**  
AISI 303 cromato  
Chrome plated AISI 303

11,5 cm - 4.52" x 19,5 cm  
7.67" x 2,1 cm - 0,82"

430 g - 15,16 oz

Supporto in legno di  
Rubberwood e posacenere  
in inox incluso  
Rubberwood support and  
stainless steel ashtray  
included



Capacità di taglio  
Cutting capacity  
22 mm - 0.86"

**749/1 SM**

**CORPO | BODY**  
AISI 440A sabbato  
Sandblasted AISI 440A  
HRC 54-56

**VITI | SCREWS**  
AISI 303 cromato  
Chrome plated AISI 303

11,5 cm - 4.52" x 19,5 cm  
7.67" x 2,1 cm - 0,82"

430 g - 15,16 oz

Supporto in legno di  
Rubberwood e posacenere  
in inox incluso  
Rubberwood support and  
stainless steel ashtray  
included

# 745 SENTA

designed by Anarcnide



## 745

**CORPO | BODY**  
AISI 420 satinato  
Satin AISI 420  
HRC 54-56



4 cm - 1.57"



28 g - 0.99 oz

Senta è un poggia sigari innovativo composto da due parti in acciaio inox, progettate per incastrarsi perfettamente tra loro, garantendo stabilità e funzionalità. Questo elegante accessorio non solo funge da supporto per il sigaro, ma offre anche la praticità di un apri capsule integrato, rendendolo un oggetto versatile e indispensabile per gli amanti del fumo.

Senta is an innovative cigar rest composed of two stainless steel parts, designed to fit together perfectly, ensuring stability and functionality. This elegant accessory not only serves as a cigar holder, but also offers the convenience of an integrated capsule opener, making it a versatile and indispensable item for smokers.

Il design di Senta è stato concepito assicurando un'elevata qualità e attenzione ai dettagli. Le due parti in acciaio inox sono state lavorate con precisione per garantire una perfetta unione, conferendo al prodotto un aspetto raffinato e moderno.

La portabilità di Senta è uno dei suoi maggiori punti di forza. Grazie al comodo sacchetto di cotone incluso, è facile da trasportare ovunque si vada, proteggendolo da graffi e danni. Inoltre, il pratico foro presente su una delle sue estremità consente di inserirlo nel portachiavi, rendendolo accessibile in ogni momento.

Senta è quindi non solo un oggetto di design, ma anche un accessorio funzionale che può essere portato per ogni occasione.

Senta's design was conceived ensuring high quality and attention to detail. The two stainless steel parts have been precision machined to ensure a perfect union, giving the product a refined and modern appearance.

Senta's portability is one of its greatest strengths. With the convenient cotton bag included, it is easy to carry wherever you go, protecting it from scratches and damage. In addition, the handy hole on one of its ends allows it to be inserted into a keychain, making it accessible at all times.

Senta is thus not only a design object, but also a functional accessory that can be carried for any occasion.



## 745 S

**CORPO | BODY**  
AISI 420 sabbiato  
Sandblasted AISI 420  
HRC 54-56



4 cm - 1.57"



28 g - 0.99 oz



## 745 F

**CORPO | BODY**  
AISI 420 black idrogliider  
Black idrogliider AISI 420  
HRC 54-56



4 cm - 1.57"



28 g - 0.99 oz

# 745

## PERSONALIZZAZIONE LASER - LASER CUSTOMIZATION



### PERSONALIZZAZIONE LASER PER IL 745 SENTA

Il modello 745 Senta rappresenta il massimo dell'eleganza e della funzionalità, con una possibilità unica di personalizzazione che lo rende un prodotto esclusivo per ogni cliente. Offriamo un servizio di incisione laser di alta precisione che permette di personalizzare il 745 Senta con disegni e testi sia sul fronte che sul retro.

#### Caratteristiche principali:

- Personalizzazione completa: grazie alla tecnologia di incisione laser, è possibile realizzare disegni dettagliati su tutta la superficie del prodotto, sia davanti che dietro.
- Quantitativo minimo di ordine: per accedere al servizio di personalizzazione, è richiesto un quantitativo minimo di ordine, permettendoci di garantire un lavoro accurato e di alta qualità.
- Versatilità di design: i clienti possono scegliere di incidere loghi aziendali, disegni artistici, testi personalizzati e molto altro, rendendo il 745 Senta un oggetto unico e personale.

#### Esempi di utilizzo:

- Regali aziendali: un'ottima scelta per regali aziendali esclusivi, personalizzabili con il logo dell'azienda o con messaggi dedicati.
- Eventi speciali: ideale per commemorare eventi speciali come anniversari, premiazioni o celebrazioni, con la possibilità di aggiungere date, nomi e disegni personalizzati.
- Uso personale: perfetto per chi desidera un oggetto di uso quotidiano che rifletta il proprio stile personale attraverso disegni e testi unici.

Il 745 Senta non è solo un prodotto, ma un accessorio personalizzabile che unisce qualità, eleganza e unicità. Contattateci oggi stesso per scoprire come possiamo trasformare la vostra idea in realtà!

### LASER CUSTOMIZATION FOR THE 745 SENTA

The 745 Senta represents the ultimate in elegance and functionality, with a unique customization option that makes it an exclusive product for every customer. We offer a high-precision laser engraving service that allows the 745 Senta to be customized with designs and text on both the front and back.

#### Key features:

- Full customization: using laser engraving technology, detailed designs can be created on the entire surface of the product, both front and back.
- Minimum order quantity: to access the customization service, a minimum order quantity is required, allowing us to ensure accurate and high-quality work.
- Design versatility: customers can choose to engrave company logos, artistic designs, custom text and more, making the 745 Senta a unique and personal item.

#### Examples of use:

- Corporate gifts: an excellent choice for exclusive corporate gifts that can be personalized with the company logo or dedicated messages.
- Special events: ideal for commemorating special events such as anniversaries, award ceremonies or celebrations, with the option of adding personalized dates, names and designs.
- Personal use: perfect for those who want an item for everyday use that reflects their personal style through unique designs and text.

The 745 Senta is not just a product, but a customizable accessory that combines quality, elegance and uniqueness. Contact us today to find out how we can turn your idea into reality!



PRODUCT-LEISURE

# 743 THE CIRCLE

Fox Knives presenta il suo nuovo tagliasigari, The Circle, un progetto che unisce eleganza, ergonomia e funzionalità in un design unico. Il cerchio, simbolo di perfezione, diventa un rifugio per le lame e il foro centrale accoglie il sigaro: cerchio dentro cerchio. Le due asole, create per muovere le lame, sono perfette per le due dita e richiamano il funzionamento di una forbice.

Ecco che nei progetti più innovativi ritornano sempre le forme e i rituali della tradizione, quasi arcaici. Sagoma e funzione si uniscono in un oggetto che fonde innovazione e tradizione. Le forme morbide e naturali, gli archetipi e la tradizione incontrano l'innovazione, i nuovi materiali, i tagli netti delle macchine e dei nuovi acciai.

Fox Knives presents its new cigar cutter, "The Circle," a project that combines elegance, ergonomics and functionality in a unique design. The circle, a symbol of perfection, becomes a shelter for the blades and the central hole accommodates the cigar: circle within a circle. The two slots, created to move the blades, are perfect for the two fingers and recall the operation of a scissor.

Here in the most innovative designs, the almost archaic forms and rituals of tradition always return. Silhouette and function come together in an object that blends innovation and tradition. Soft, natural forms, archetypes and tradition meet innovation, new materials, clean cuts from machines and new steels.

NEW ITEM



### 743 3KT

**LAMA | BLADE**  
Sandvik 12C27 PVD nero  
Black PVD Sandvik 12C27  
HRC 55-57

**CORPO | BODY**  
3K Twill by Fat Carbon®

**VITI | SCREWS**  
AISI 303 anodizzato blu  
Blue anodized AISI 303

8,5 cm - 3.35"

75 g - 2.65 oz

NEW ITEM



### 743 OR

**LAMA | BLADE**  
Sandvik 12C27 Top Shield® nero  
Black Top Shield® Sandvik 12C27  
HRC 55-57

**CORPO | BODY**  
Alluminio anodizzato  
arancione  
Orange anodized  
aluminium

**VITI | SCREWS**  
AISI 303 Top Shield® nero  
Black Top Shield® AISI 303

8,5 cm - 3.35"

95 g - 3.35 oz

NEW ITEM



### 743 B

**LAMA | BLADE**  
Sandvik 12C27 satinato  
Satin Sandvik 12C27  
HRC 55-57

**CORPO | BODY**  
Alluminio anodizzato nero  
Black anodized aluminium

**VITI | SCREWS**  
AISI 303 Top Shield® nero  
Black Top Shield® AISI 303

8,5 cm - 3.35"

95 g - 3.35 oz

NEW ITEM



### 743

**LAMA | BLADE**  
Sandvik 12C27 satinato  
Satin Sandvik 12C27  
HRC 55-57

**CORPO | BODY**  
Alluminio anodizzato  
bronzo  
Bronze anodized  
aluminium

**VITI | SCREWS**  
AISI 303 Top Shield® nero  
Black Top Shield® AISI 303

8,5 cm - 3.35"

95 g - 3.35 oz

# 744 THE CIRCLE



## 744 CFD

NEW ITEM

**LAMA | BLADE**  
Sandvik 12C27 PVD nero  
Black PVD Sandvik 12C27  
HRC 55-57

**CORPO | BODY**  
Titanio PVD nero + inserti  
Dark Matter di Fat Carbon®  
Black PVD titanium + Dark  
Matter by Fat Carbon® inserts

**VITI | SCREWS**  
AISI 303 PVD nero  
Black PVD AISI 303



Cuoio marrone  
Brown leather

8,5 cm - 3.35"

105 g - 3.70 oz



## 744 CFF

NEW ITEM

**LAMA | BLADE**  
Sandvik 12C27 PVD nero  
Black PVD Sandvik 12C27  
HRC 55-57

**CORPO | BODY**  
Titanio PVD nero + inserti  
Forged di Fat Carbon®  
Black PVD titanium + Forged  
by Fat Carbon® inserts

**VITI | SCREWS**  
AISI 303 PVD nero  
Black PVD AISI 303



Cuoio marrone  
Brown leather

8,5 cm - 3.35"

105 g - 3.70 oz

La caratteristica distintiva di "The Circle" è rappresentata dalle sue due lame, che emergono dal cerchio tramite anelli. Questi anelli ricordano l'utilizzo di una forbice, permettendo un taglio preciso e netto del sigaro. Il meccanismo di taglio è estremamente intuitivo: posizionando il sigaro nel foro centrale e chiudendo le due asole, il sigaro viene tagliato con facilità e precisione.

Esteticamente, "The Circle" si presenta con linee pulite e una forma simmetrica, che ne esalta l'eleganza. Fox Knives offre una varietà di finiture per questo modello, dalle più semplici e naturali, come il legno, alle più pregiate, come la fibra di carbonio. Questa gamma di opzioni permette a ogni appassionato di sigari di trovare il tagliasigari che meglio rispecchia il proprio stile e gusto personale.

A differenza del modello 743, il The Circle 744 si caratterizza per l'integrazione di raffinati inserti in titanio, offrendo una variante estetica unica e l'impiego di materiali e abbinamenti innovativi.

The distinctive feature of "The Circle" is its two blades, which emerge from the circle via rings. These rings are reminiscent of the use of a scissor, allowing a precise and clean cut of the cigar. The cutting mechanism is extremely intuitive: by placing the cigar in the center hole and closing the two loops, the cigar is cut with ease and precision.

Aesthetically, "The Circle" features clean lines and a symmetrical shape, which enhances its elegance. Fox Knives offers a variety of finishes for this model, from the simplest and most natural, such as wood, to the finest, such as carbon fiber. This range of options allows every cigar enthusiast to find the cigar cutter that best reflects their personal style and taste.

Different from the 743 model, The Circle 744 features the integration of refined titanium inserts, offering a unique aesthetic variation and the use of innovative materials and combinations.



NEW ITEM



Cuoio marrone  
Brown leather

## 744

**LAMA | BLADE**  
Sandvik 12C27 satinato  
Satin Sandvik 12C27  
HRC 55-57

**CORPO | BODY**  
Titanio sabbato + inserti  
alluminio anodizzato bronzo  
Sandblasted titanium + bronze  
anodized titanium inserts

**VITI | SCREWS**  
AISI 303 sabbato  
Sandblasted AISI 303

8,5 cm - 3.35"

100 g - 3.52 oz



NEW ITEM



Cuoio marrone  
Brown leather

## 744 OL

**LAMA | BLADE**  
Sandvik 12C27 satinato  
Satin Sandvik 12C27  
HRC 55-57

**CORPO | BODY**  
Titanio anodizzato bronzo +  
inserti in ulivo  
Bronze anodized titanium +  
olive wood inserts

**VITI | SCREWS**  
AISI 303 sabbato  
Sandblasted AISI 303

8,5 cm - 3.35"

100 g - 3.52 oz



NEW ITEM



Cuoio marrone  
Brown leather

## 744 ZW

**LAMA | BLADE**  
Sandvik 12C27 satinato  
Satin Sandvik 12C27  
HRC 55-57

**CORPO | BODY**  
Titanio anodizzato bronzo +  
inserti in Ziricote  
Bronze anodized titanium +  
Ziricote wood inserts

**VITI | SCREWS**  
AISI 303 sabbato  
Sandblasted AISI 303

8,5 cm - 3.35"

100 g - 3.52 oz



NEW ITEM



Cuoio marrone  
Brown leather

## 744 AW

**LAMA | BLADE**  
Sandvik 12C27 satinato  
Satin Sandvik 12C27  
HRC 55-57

**CORPO | BODY**  
Titanio anodizzato bronzo +  
inserti in noce americano  
Bronze anodized titanium +  
american walnut wood inserts

**VITI | SCREWS**  
AISI 303 sabbato  
Sandblasted AISI 303

8,5 cm - 3.35"

100 g - 3.52 oz

# FX-541 VIRTUS

Il VIRTUS: il nuovo coltello taglia sigari di Fox Knives. Un'intrigante fusione di tradizione e innovazione nel mondo degli accessori per fumatori. Il VIRTUS è il risultato di un'attenta considerazione dell'arte di fumare il sigaro, combinando la tradizionale abilità artigianale italiana nella produzione di coltelli con le esigenze e le preferenze del moderno appassionato di sigari. Fox Knives, rinomata per la sua eccellenza nel settore dei coltelli, ha portato avanti questo progetto con la precisione e l'attenzione ai dettagli che da sempre caratterizzano i suoi prodotti. Ciò che rende unico il VIRTUS è la sua versatilità. Non è solo un taglia sigari di precisione, ma un pezzo di design funzionale che racchiude diverse utilità in una forma elegante. Il design ergonomico consente una presa comoda e sicura, mentre la lama affilata assicura un taglio netto e preciso senza danneggiare il sigaro. Ma le caratteristiche del VIRTUS non si fermano qui. Grazie alla costruzione robusta e alla scelta di materiali di alta qualità, questo coltello è progettato per resistere alla prova del tempo e diventare un fedele compagno per gli amanti dei sigari in tutte le loro avventure.

The VIRTUS: The New Cigar Cutter Knife from Fox Knives. An intriguing fusion of tradition and innovation in the world of smoking accessories. The VIRTUS is the result of careful consideration of the art of cigar smoking, combining traditional Italian craftsmanship in knife making with the needs and preferences of the modern cigar enthusiast. Fox Knives, renowned for its excellence in the knife industry, has pursued this project with the precision and attention to detail that has always characterized its products. What makes the VIRTUS unique is its versatility. It is not just a precision cigar cutter, but a piece of functional design that packs several utilities into one elegant shape. The ergonomic design allows for a comfortable and secure grip, while the sharp blade ensures a clean and precise cut without damaging the cigar. But the features of the VIRTUS do not stop there. With its sturdy construction and choice of high-quality materials, this knife is designed to stand the test of time and become a faithful companion for cigar lovers on all their adventures.



Cuoio nero  
Black leather

## FX-541 DMG SLIP JOINT

70 g / 2.47 oz



16,5 cm - 6.50"



3 mm - 0.12"



6,4 cm - 2.51"



Cuoio nero  
Black leather

## FX-541 CF SLIP JOINT

70 g / 2.47 oz



16,5 cm - 6.50"



3 mm - 0.12"



6,4 cm - 2.51"



Cuoio nero  
Black leather

## FX-541 TI SLIP JOINT

165 gr - 5.82 oz



16,5 cm - 6.50"



3 mm - 0.12"



6,4 cm - 2.51"



Cuoio marrone  
Brown leather

## FX-541 ST SLIP JOINT

65 g - 2.29 oz



16,5 cm - 6.50"



3 mm - 0.12"



6,4 cm - 2.51"



Cuoio marrone  
Brown leather

## FX-541 WW SLIP JOINT

65 g - 2.29 oz



16,5 cm - 6.50"



3 mm - 0.12"



6,4 cm - 2.51"



- Super Dense Twist by Damasteel® HRC 59-61
- Dark Matter Gold by Fat Carbon®
- Titanio sabbiato Sandblasted titanium
- Titanio anodizzato bronzo Bronze anodized titanium
- Titanio anodizzato bronzo Bronze anodized titanium

- Becut PVD nero Black PVD Be cut HRC 56-58
- Fibra di carbonio 3K Twill 3K Twill carbon fiber
- Titanio PVD nero Black PVD titanium
- Titanio anodizzato bronzo Bronze anodized titanium
- Titanio anodizzato bronzo Bronze anodized titanium

- Becut satinato Satin Be cut HRC 56-58
- Titanio sabbiato Sandblasted titanium
- Titanio anodizzato blu Blue anodized titanium
- Titanio anodizzato blu Blue anodized titanium
- Titanio anodizzato blu Blue anodized titanium

- Becut satinato Satin Be cut HRC 56-58
- Palissandro Santos Santos Rosewood
- AISI 420 burattato Tumbled AISI 420
- AISI 420 burattato Tumbled AISI 420
- AISI 303 lucido Polished AISI 303

- Becut satinato Satin Be cut HRC 56-58
- Noce Americano American Walnut wood
- AISI 420 burattato Tumbled AISI 420
- AISI 420 burattato Tumbled AISI 420
- AISI 303 lucido Polished AISI 303



## **LINEA CLASSICA** CLASSIC LINE

Fox Knives vuole affondare le radici nella cultura maniaghese che vede questa città produrre coltelli da centenni. Una collezione di coltelli per chi ama la tradizione, un compromesso tra passato e futuro che non invecchia mai grazie ai materiali pregiati e al design che rivisita le forme vintage della coltelleria.

Fox Knives wants to sink its roots into the Maniago culture that has seen this city produce knives for centennials. A collection of knives for those who love tradition, a compromise between the past and the future that never gets old thanks to fine materials and a design that revisits vintage forms of cutlery.



Cuoio nero  
Black leather

**273 DOL**  
LINER LOCK



95 g - 3.35 oz



19.3 cm - 7.60"



3 mm - 0.12"



8 cm - 3.15"



Super Dense Twist™ by Damasteel®  
HRC 59-61

Ulivo + mostrine AISI 304  
Olive wood + AISI 304 bolsters

AISI 420 lucido  
Polished AISI 420

AISI 420 lucido  
Polished AISI 420

AISI 303 lucido  
Polished AISI 303

**273 OL**  
LINER LOCK



95 g - 3.35 oz



19.3 cm - 7.60"



3 mm - 0.12"



8 cm - 3.15"



N690Co satinato  
Satin N690Co  
HRC 58-60

Ulivo + mostrine AISI 304  
Olive wood + AISI 304 bolsters

AISI 420 lucido  
Polished AISI 420

AISI 420 lucido  
Polished AISI 420

AISI 303 lucido  
Polished AISI 303

**271 OL**  
LINER LOCK



47 g - 1.65 oz



17.5 cm - 6.88"



3 mm - 0.12"



8 cm - 3.15"



N690Co satinato  
Satin N690Co  
HRC 58-60

Ulivo + mostrine AISI 304  
Olive wood + AISI 304 bolsters

AISI 420 lucido  
Polished AISI 420

AISI 420 lucido  
Polished AISI 420

AISI 303 lucido  
Polished AISI 303



Cuoio nero  
Black leather

**500 B**  
BACK LOCK



70 g - 2.46 oz



18 cm - 7.08"



3 mm - 0.12"



8.5 cm - 3.34"



Sandvik 12C27 satinato  
Satin Sandvik 12C27  
HRC 56-58

G10 nero  
Black G10

AISI 420 lucido  
Polished AISI 420

AISI 420 lucido  
Polished AISI 420

AISI 303 lucido  
Polished AISI 303



Cuoio nero  
Black leather

**573 CF**  
BACK LOCK

**LAMA | BLADE**  
AISI 440 satinato  
Satin AISI 440  
HRC 57-59

**DISTANZIALE | SPACER**  
AISI 420 lucido  
Polished AISI 420

**MANICO | HANDLE**  
Fibra di carbonio  
Carbon fiber

**VITI | SCREWS**  
AISI 303 lucido  
Polished AISI 303

**BACK LOCK**  
AISI 420 lucido  
Polished AISI 420

7 cm - 2.75"

2 mm - 0.08"

17 cm - 6.69"

30 g - 1.05 oz

**GENTLEMAN**  
**221/1**  
SLIP JOINT

**LAMA | BLADE**  
AISI 420 satinato  
Satin AISI 420  
HRC 54-56

**MANICO | HANDLE**  
AISI 430 lucido  
Polished AISI 430

**SLIP JOINT**  
AISI 430 lucido  
Polished AISI 430

6,5 cm - 2.55"

2,5 mm - 0.10"

14,5 cm - 5.70"

35 g - 1.23 oz

designed by Ron Lake

**FX-RL01 G10**  
BACK LOCK

**LAMA | BLADE**  
N690Co satinato  
Satin N690Co  
HRC 58-60

**DISTANZIALE | SPACER**  
AISI 420 lucido  
Polished AISI 420

**MANICO | HANDLE**  
G10 nero  
Black G10

**VITI | SCREWS**  
AISI 303 lucido  
Polished AISI 303

**BACK LOCK**  
AISI 420 lucido  
Polished AISI 420

8 cm - 3.14"

3 mm - 0.12"

18.5 cm - 7.28"

120 g - 4.23 oz

**GENTLEMAN**  
**590**  
SLIP JOINT

**LAMA | BLADE**  
AISI 440 satinato  
Satin AISI 440  
HRC 57-59

**MANICO | HANDLE**  
AISI 430 lucido  
Polished AISI 430

**SLIP JOINT**  
AISI 430 lucido  
Polished AISI 430

3 cm - 1.18"

1,5 mm - 0.05"

7 cm - 2.75"

15 g - 0.52 oz



Nylon®

**FOREST  
575PW**  
BACK LOCK

**LAMA | BLADE**  
N690Co satinato  
Satin N690Co  
HRC 58-60

**BACK LOCK**  
AISI 420 lucido  
Polished AISI 420

**MANICO | HANDLE**  
Pakkawood + mostrine  
AISI 430 lucido  
Pakkawood + polished  
AISI 430 bolsters

**VITI | SCREWS**  
Ottone lucido  
Polished brass

|  |                 |  |                 |
|--|-----------------|--|-----------------|
|  | 7,5 cm - 2.95"  |  | 3 mm - 0.12"    |
|  | 17,5 cm - 6.88" |  | 120 g - 4.23 oz |



**WIN COLLECTION  
583**  
BACK LOCK

**LAMA | BLADE**  
Sandvik 12C27 satinato  
Satin Sandvik 12C27  
HRC 55-57

**BACK LOCK**  
AISI 420 lucido  
Polished AISI 420

**MANICO | HANDLE**  
Palissandro + mostrine  
AISI 430 lucido  
Palissander wood +  
polished AISI 430 bolsters

**VITI | SCREWS**  
Ottone lucido  
Polished brass

|  |                |  |                |
|--|----------------|--|----------------|
|  | 9,5 cm - 3.74" |  | 3 mm - 0.12"   |
|  | 22 cm - 8.66"  |  | 150g - 5.29 oz |



**594 OL**  
BACK LOCK

|  |                |  |                |  |               |  |                 |
|--|----------------|--|----------------|--|---------------|--|-----------------|
|  | 7,5 cm - 2.95" |  | 3,5 mm - 0.14" |  | 19 cm - 7.48" |  | 145 g - 5.11 oz |
|--|----------------|--|----------------|--|---------------|--|-----------------|

**LAMA | BLADE**  
N690Co satinato  
Satin N690Co  
HRC 58-60

**MANICO | HANDLE**  
Ulivo + mostrine AISI 304  
Olive wood + AISI 304 bolsters

**BACK LOCK**  
AISI 420 lucido  
Polished AISI 420



Cuoio marrone  
Brown leather



**SILVER COLLECTION  
593**  
BACK LOCK

**LAMA | BLADE**  
AISI 440C satinato  
Satin AISI 440C  
HRC 55-57

**BACK LOCK**  
AISI 420 lucido  
Polished AISI 420

**MANICO | HANDLE**  
Palissandro + mostrine  
AISI 304 lucido  
Palissander wood +  
polished AISI 304 bolsters

|  |               |  |                |
|--|---------------|--|----------------|
|  | 6 cm - 2.36"  |  | 3 mm - 0.12"   |
|  | 15 cm - 5.90" |  | 90 g - 3.17 oz |



Cuoio marrone  
Brown leather

**SILVER COLLECTION  
593CE**  
BACK LOCK

**LAMA | BLADE**  
AISI 440C satinato  
Satin AISI 440C  
HRC 55-57

**BACK LOCK**  
AISI 420 lucido  
Polished AISI 420

**MANICO | HANDLE**  
Corno di cervo + mostrine  
AISI 430 lucido  
Stag horn + polished AISI  
430 bolsters

**VITI | SCREWS**  
Ottone lucido  
Polished brass

|  |               |  |                |
|--|---------------|--|----------------|
|  | 6 cm - 2.36"  |  | 3 mm - 0.12"   |
|  | 15 cm - 5.90" |  | 90 g - 3.17 oz |



**594 RF**  
BACK LOCK

**LAMA | BLADE**  
N690Co satinato  
Satin N690Co  
HRC 58-60

**MANICO | HANDLE**  
Radica + mostrine AISI 304  
Briar root + AISI 304 bolsters

**BACK LOCK**  
AISI 420 lucido  
Polished AISI 420

|  |                |  |                 |
|--|----------------|--|-----------------|
|  | 7,5 cm - 2.95" |  | 3,5 mm - 0.14"  |
|  | 19 cm - 7.48"  |  | 155 g - 5.46 oz |

**594 MI**  
BACK LOCK

**LAMA | BLADE**  
N690Co satinato  
Satin N690Co  
HRC 58-60

**MANICO | HANDLE**  
Micarta nera + mostrine AISI 304  
Black Micarta + AISI 304 bolsters

**BACK LOCK**  
AISI 420 lucido  
Polished AISI 420

|  |                |  |                 |
|--|----------------|--|-----------------|
|  | 7,5 cm - 2.95" |  | 3,5 mm - 0.14"  |
|  | 19 cm - 7.48"  |  | 155 g - 5.46 oz |



Cuoio marrone  
Brown leather

### COLTELLO DA CAMPEGGIO CAMPING KNIFE 610/11

FIXED BLADE

**LAMA | BLADE**  
AISI 420 satinato  
Satin AISI 420  
HRC 54-56

**MANICO | HANDLE**  
Cuoio + elsa AISI 420 lucido  
Leather + polished AISI 420  
pommel

11,5 cm - 4.52"

3 mm - 0.12"

22 cm - 8.66"

105 g - 6.34 oz



Cuoio marrone  
Brown leather

### COLTELLO DA CAMPEGGIO CAMPING KNIFE 610/13

FIXED BLADE

**LAMA | BLADE**  
AISI 420 satinato  
Satin AISI 420  
HRC 54-56

**MANICO | HANDLE**  
Cuoio + elsa AISI 420 lucido  
Leather + polished AISI 420  
pommel

13,5 cm - 24,5"

3 mm - 0.12"

24,5 cm - 9.64"

130 g - 4.58 oz



Cuoio marrone  
Brown leather

### VINTAGE 639 CE

FIXED BLADE

**LAMA | BLADE**  
AISI 440C satinato  
Satin AISI 440C  
HRC 55-57

**MANICO | HANDLE**  
Corno di cervo  
Stag horn

**VITI | SCREWS**  
AISI 303 lucido  
Polished AISI 303

11 cm - 4.33"

3 mm - 0.12"

22 cm - 8.66"

100 g - 3.52oz



### TEKNO SUB 646/11

FIXED BLADE

**LAMA | BLADE**  
AISI 420 lucido  
Polished AISI 420  
HRC 54-56

**MANICO | HANDLE**  
Nylon® nero + gomma nera  
Black Nylon® and black rubber

11 cm - 4.33"

4 mm - 0.16"

21,5 cm - 8.46"

145 g - 5.11 oz



Nylon® grigio + lacci di gomma  
Gray Nylon® + rubber straps



Cuoio marrone  
Brown leather

### SPECIAL HUNTER 647

FIXED BLADE

**LAMA | BLADE**  
AISI 440B satinato  
Satin AISI 440B  
HRC 56-58

**MANICO | HANDLE**  
Palissandro  
Palissander wood

**RIVETTI | RIVETS**  
Ottone lucido  
Polished brass

19 cm - 7.48"

4 mm - 0.16"

30,5 cm - 12"

270 g - 9.52 oz



Cuoio marrone  
Brown leather

### SPECIAL HUNTER 648

FIXED BLADE

**LAMA | BLADE**  
AISI 440B satinato  
Satin AISI 440B  
HRC 56-58

**MANICO | HANDLE**  
Corno di cervo  
Stag horn

**RIVETTI | RIVETS**  
Ottone lucido  
Polished brass

19 cm - 7.48"

4 mm - 0.16"

30,5 cm - 12"

270 g - 9.52 oz



Cuoio marrone  
Brown leather

### PERSIAN HUNTER 445OL

FIXED BLADE

**LAMA | BLADE**  
N690Co satinato  
Satin N690Co  
HRC 58-60

**MANICO | HANDLE**  
Ulivo  
Olive wood

**VITI | SCREWS**  
AISI 303 lucido  
Polished AISI 303

12 cm - 4.72"

4 mm - 0.16"

23 cm - 9.05"

236 g - 8.32 oz



Nylon® grigio + lacci di gomma  
Gray Nylon® + rubber straps

### TEKNO MILITARY 643/11

FIXED BLADE

**LAMA | BLADE**  
AISI 420 black idrogliider  
Black idrogliider AISI 420  
HRC 54-56

**MANICO | HANDLE**  
Nylon® nero + gomma nera  
Black Nylon® and black rubber

11 cm - 4.33"

4 mm - 0.16"

21 cm - 8.26"

140 g - 4.93 oz



Nylon® grigio + lacci di gomma  
Gray Nylon® + rubber straps

### TEKNO MILITARY 641

FIXED BLADE

**LAMA | BLADE**  
AISI 420 black idrogliider  
Black idrogliider AISI 420  
HRC 54-56

**MANICO | HANDLE**  
Nylon® nero + gomma nera  
Black Nylon® and black rubber

12 cm - 7.72"

4 mm - 0.16"

24 cm - 9.44"

160 g - 5.64 oz



### 251

AUTOMATICO  
AUTOMATIC

**LAMA | BLADE**  
AISI 420C satinato  
Satin AISI 420C  
HRC 54-56

**CORPO | BODY**  
Alluminio anodizzato verde  
Green anodized aluminium

7 cm - 2.75"

2 mm - 0.08"

17 cm - 6.69"

70 g - 2.46 oz



### 256

AUTOMATICO  
AUTOMATIC

**LAMA | BLADE**  
AISI 420C satinato  
Satin AISI 420C  
HRC 54-56

**CORPO | BODY**  
Alluminio anodizzato nero  
Black anodized aluminium

6 cm - 2.36"

2 mm - 0.08"

15 cm - 5.90"

55 g - 1.94 oz



### 257

AUTOMATICO  
AUTOMATIC

**LAMA | BLADE**  
AISI 420C satinato  
Satin AISI 420C  
HRC 54-56

**CORPO | BODY**  
Alluminio anodizzato grigio  
Gray anodized aluminium

8,5 cm - 3.34"

2 mm - 0.08"

25,5 cm - 8.07"

90 g - 3.017 oz



### PALLOTTOLA 44 MAGNUM 201

SLIP JOINT

**LAMA | BLADE**  
AISI 420C satinato  
Satin AISI 420C  
HRC 54-56

3 cm - 1.18"

2 mm - 0.08"

7 cm - 2.75"

20 g - 0.70 oz



### MOD CARTRUCCIA "30-06" 202

SLIP JOINT

**LAMA | BLADE**  
AISI 420C satinato  
Satin AISI 420C  
HRC 54-56

4 cm - 1.57"

2 mm - 0.08"

12 cm - 4.72"

40 g - 1.41 oz



### MOD CARTRUCCIA "GAUGE 12" 294

SLIP JOINT

**LAMA | BLADE**  
AISI 420C satinato  
Satin AISI 420C  
HRC 54-56

4,5 cm - 1.77"

2 mm - 0.08"

11 cm - 4.33"

30 g - 1.05 oz

Disponibile con manico  
arancione, rosso, blu, verde  
o nero  
Available with orange, red,  
blue, green or black handle



### MINI RAMBLER 1699 CH

FIXED BLADE

**LAMA | BLADE**  
AISI 420C satinato  
Satin AISI 420C  
HRC 54-56

**MANICO | HANDLE**  
Alluminio anodizzato champagne  
+ guardia AISI 430 black idrogliider  
Champagne anodized aluminium  
+ black idrogliider AISI 430 guard

6,5 cm - 2.55"

2,5 mm - 0.10"

11,5 cm - 4.52"

25 g - 0.88 oz



Cuoio nero  
Black leather



### MINI RAMBLER 1699 N

FIXED BLADE

**LAMA | BLADE**  
AISI 420C satinato  
Satin AISI 420C  
HRC 54-56

**MANICO | HANDLE**  
Alluminio anodizzato nero + guardia  
AISI 430 black idrogliider  
Black anodized aluminium + black  
idrogliider AISI 430 guard

6,5 cm - 2.55"

2,5 mm - 0.10"

11,5 cm - 4.52"

25 g - 0.88 oz



### 697 T

FIXED BLADE

**LAMA | BLADE**  
AISI 440A black idrogliider  
Black idrogliider AISI 440A  
HRC 55-57

**MANICO | HANDLE**  
ABS nero + guardia AISI 340  
black idrogliider  
Black ABS + black idrogliider  
AISI 340 guard

Inclusi/Included:  
Kit di sopravvivenza, bussola  
e pietra per affilare  
Survival kit, compass, and  
sharpening stone

18,5 cm - 7.28"

5 mm - 0.19"

32,5 cm - 12.79"

400 g - 14.10 oz



Cuoio nero  
Black leather



### 698

FIXED BLADE

**LAMA | BLADE**  
AISI 440A satinato  
Satin AISI 440A  
HRC 55-57

**MANICO | HANDLE**  
ABS nero + guardia AISI 340  
black idrogliider  
Black ABS + black idrogliider  
AISI 340 guard

Inclusi/Included:  
Kit di sopravvivenza, bussola  
e pietra per affilare  
Survival kit, compass, and  
sharpening stone

18,5 cm - 7.28"

5 mm - 0.19"

32,5 cm - 12.79"

400 g - 14.10 oz



## **FKMD**

Già dal 1982 le Coltellerie FOX iniziarono a fornire i vari reparti italiani impegnati nelle missioni di pace in Libano e, da allora, si è continuato a rispondere alle rigorose richieste dell'Esercito, dei Corpi Militari e dei Reparti d'Elite che necessitano di strumenti di supporto efficaci e qualificati. Grazie all'elevato standard qualitativo in Italia e all'estero, l'azienda è stata riconosciuta nell'albo dei fornitori ufficiali NATO con il codice N/CAGE CODE: AG180.

Nel 2005 è stato creato il marchio FKMD (Fox Knives Military Division) per distinguere la produzione tattico-militare da quella civile. L'azienda è certificata ISO 9001 con personale altamente qualificato, macchinari a controllo numerico di ultima generazione, un alto contenuto tecnologico e una vasta scelta dei migliori materiali da impiegare durante le fasi di campionatura e di produzione.

As early as 1982, FOX Cutlery began supplying the various Italian units engaged in peacekeeping missions in Lebanon, and since then has continued to meet the rigorous demands of the Army, Military Corps and Elite Units in need of effective and qualified support tools. Due to the high-quality standard in Italy and abroad, the company has been recognized in the official NATO supplier register with N/CAGE CODE: AG180. In 2005, the FKMD (Fox Knives Military Division) brand was created to distinguish tactical-military production from civilian production. The company is ISO 9001 certified with highly qualified staff, the latest numerical control machinery, high technological content and a wide selection of the best materials to be used during the sampling and production stages.

The company is ISO 9001 certified with highly qualified staff, the latest numerical control machinery, high technological content and a wide selection of the best materials to be used during the sampling and production stages.

# FX-446 PREDATOR II

Un coltello tattico chiudibile progettato per interventi di soccorso, operazioni di rescue ed emergenze, caratterizzato da un meccanismo di blocco liner lock. Questo strumento è concepito per fornire una rapida risposta in situazioni critiche, consentendo un accesso immediato e sicuro alla lama grazie al meccanismo di apertura automatica. La sua progettazione ergonomicamente ottimizzata e la resistenza dei materiali impiegati lo rendono uno strumento affidabile e versatile per operatori di soccorso, personale di emergenza e professionisti del settore.

A foldable tactical knife designed for rescue operations, rescue missions, and emergencies, characterized by a liner lock mechanism. This tool is designed to provide a quick response in critical situations, allowing immediate and secure access to the blade through the automatic opening mechanism. Its ergonomically optimized design and the durability of the materials used make it a reliable and versatile tool for rescue operators, emergency personnel, and industry professionals.



**FX-446 BS**  
LINER LOCK

145 g - 5,11 oz



21 cm - 8,26"



3 mm - 0,12"



9,5 cm - 3,74"



N690Co black idrogliider  
Black idrogliider N690Co  
HRC 58-60



FRN® nero  
Black FRN®



AISI 420 black idrogliider  
Black idrogliider AISI 420



Polimero nero  
Black polimer



Sagomata in AISI 420 black idrogliider  
Black idrogliider shaped AISI 420



AISI 303 rivestito al nichel  
Nickel plated AISI 303



**FX-446 ODS**  
LINER LOCK

145 g - 5,11 oz



21 cm - 8,26"



3 mm - 0,12"



9,5 cm - 3,74"



N690Co black idrogliider  
Black idrogliider N690Co  
HRC 58-60



FRN® verde OD  
OD green FRN®



AISI 420 black idrogliider  
Black idrogliider AISI 420



Polimero nero  
Black polimer



Sagomata in AISI 420 black idrogliider  
Black idrogliider shaped AISI 420



AISI 303 rivestito al nichel  
Nickel plated AISI 303



**FX-446 B**  
LINER LOCK

145 g - 5,11 oz



21 cm - 8,26"



3 mm - 0,12"



9,5 cm - 3,74"



N690Co black idrogliider  
Black idrogliider N690Co  
HRC 58-60



FRN® nero  
Black FRN®



AISI 420 black idrogliider  
Black idrogliider AISI 420



Polimero nero  
Black polimer



Sagomata in AISI 420 black idrogliider  
Black idrogliider shaped AISI 420



AISI 303 rivestito al nichel  
Nickel plated AISI 303



**FX-446 OD**  
LINER LOCK

145 g - 5,11 oz



21 cm - 8,26"



3 mm - 0,12"



9,5 cm - 3,74"



N690Co black idrogliider  
Black idrogliider N690Co  
HRC 58-60



FRN® verde OD  
OD green FRN®



AISI 420 black idrogliider  
Black idrogliider AISI 420



Polimero nero  
Black polimer



Sagomata in AISI 420 black idrogliider  
Black idrogliider shaped AISI 420



AISI 303 rivestito al nichel  
Nickel plated AISI 303



**FX-446 GR**  
LINER LOCK

145 g - 5,11 oz



21 cm - 8,26"



3 mm - 0,12"



9,5 cm - 3,74"



N690Co black idrogliider  
Black idrogliider N690Co  
HRC 58-60



FRN® grigio  
Grey FRN®



AISI 420 black idrogliider  
Black idrogliider AISI 420



Polimero nero  
Black polimer



Sagomata in AISI 420 black idrogliider  
Black idrogliider shaped AISI 420



AISI 303 rivestito al nichel  
Nickel plated AISI 303



**FX-448 B**  
AUTOMATICO/AUTOMATIC  
Automatico con blocco di sicurezza  
Automatic with Safety lock

145 g - 5.11 oz



21 cm - 8.26"



3 mm - 0.12"



9.5 cm - 3.74"



- N690Co black idrogliker  
Black idrogliker N690Co  
HRC 58-60
- FRN® nero  
Black FRN®
- AISI 420 black idrogliker  
Black idrogliker AISI 420
- Polimero nero  
Black polimer
- Sagomata in AISI 420 black idrogliker  
Black idrogliker shaped AISI 420
- AISI 303 rivestito al nichel  
Nickel plated AISI 303

**FX-448 OD**  
AUTOMATICO/AUTOMATIC  
Automatico con blocco di sicurezza  
Automatic with Safety lock

145 g - 5.11 oz



21 cm - 8.26"



3 mm - 0.12"



9.5 cm - 3.74"



- N690Co black idrogliker  
Black idrogliker N690Co  
HRC 58-60
- FRN® verde OD  
OD green FRN®
- AISI 420 black idrogliker  
Black idrogliker AISI 420
- Polimero nero  
Black polimer
- Sagomata in AISI 420 black idrogliker  
Black idrogliker shaped AISI 420
- AISI 303 rivestito al nichel  
Nickel plated AISI 303

**FX-448 T**  
AUTOMATICO/AUTOMATIC  
Automatico con blocco di sicurezza  
Automatic with Safety lock

145 g - 5.11 oz



21 cm - 8.26"



3 mm - 0.12"



9.5 cm - 3.74"



- N690Co black idrogliker  
Black idrogliker N690Co  
HRC 58-60
- FRN® coyote tan  
Coyote tan FRN®
- AISI 420 black idrogliker  
Black idrogliker AISI 420
- Polimero nero  
Black polimer
- Sagomata in AISI 420 black idrogliker  
Black idrogliker shaped AISI 420
- AISI 303 rivestito al nichel  
Nickel plated AISI 303

# FX-449 PREDATOR EVOLUTION

**FX-449 B**  
LINER LOCK

NEW ITEM

145 g - 5.11 oz



21 cm - 8.26"



3 mm - 0.12"



9.5 cm - 3.74"



- Niolox black idrogliker  
Black idrogliker Niolox  
HRC 59-61
- FRN® nero  
Black FRN®
- AISI 420 black idrogliker  
Black idrogliker AISI 420
- Polimero nero  
Black polimer
- Sagomata in AISI 420  
black idrogliker  
Black idrogliker shaped  
AISI 420
- AISI 303 rivestito al nichel  
Nickel plated AISI 303

**FX-449 OD**  
LINER LOCK

NEW ITEM

145 g - 5.11 oz



21 cm - 8.26"



3 mm - 0.12"



9.5 cm - 3.74"



- Niolox black idrogliker  
Black idrogliker Niolox  
HRC 59-61
- FRN® verde OD  
OD green FRN®
- AISI 420 black idrogliker  
Black idrogliker AISI 420
- Polimero nero  
Black polimer
- Sagomata in AISI 420  
black idrogliker  
Black idrogliker shaped  
AISI 420
- AISI 303 rivestito al nichel  
Nickel plated AISI 303



Nylon®

**A.L.S.R. 49°  
CAPRICORNO  
FX-ALSR-49**  
LINER LOCK



95 g - 3.35 oz



19,3 cm - 7.60"



3 mm - 0.12"



8 cm - 3.15"



N690Co black idroglied  
Black idroglied N690Co  
HRC 58-60

FRN® nero  
Black FRN®

AISI 420 black idroglied  
Black idroglied AISI 420

AISI 420 lucido  
Polished AISI 420

Sagomata in AISI 420 black idroglied  
Black idroglied shaped AISI 420

AISI 303 rivestito al nichel  
Nickel plated AISI 303

Frangivetro in N690Co  
black idroglied  
Black idroglied N690Co  
glass breaker



Nylon®

**R.C.S.T.F.  
FX-RCSTF-02**  
LINER LOCK



95 g - 3.35 oz



19,3 cm - 7.60"



3 mm - 0.12"



8 cm - 3.15"



N690Co PVD grigio  
Grey PVD N690Co  
HRC 58-60

G10 nero  
Black G10

AISI 420 black idroglied  
Black idroglied AISI 420

AISI 420 black idroglied  
Black idroglied AISI 420

Sagomata in AISI 420 black idroglied  
Black idroglied shaped AISI 420

AISI 303 rivestito al nichel  
Nickel plated AISI 303

Frangivetro in N690Co  
black idroglied  
Black idroglied N690Co  
glass breaker



Nylon®

**A.L.S.R. 2 AIR LAND  
& SEA RESCUE  
FX-447 C**  
LINER LOCK



47 g - 1.65 oz



17,5 cm - 6.88"



3 mm - 0.12"



8 cm - 3.15"



N690Co satinato  
Satin N690Co  
HRC 58-60

FRN® rosso e giallo  
Red and yellow FRN®

AISI 420 lucido  
Polished AISI 420

AISI 420 lucido  
Polished AISI 420

Sagomata in AISI 420 black idroglied  
Black idroglied shaped AISI 420

AISI 303 rivestito al nichel  
Nickel plated AISI 303

Frangivetro in N690Co lucido  
Polished N690Co glass breaker



Nylon® + lacci di gomma  
Nylon® + rubber straps

**FX-401 OR**  
LINER LOCK

Con blocco di sicurezza L.A.W.K.S.®  
With L.A.W.K.S.® safety lock

**LAMA | BLADE**  
N690Co PVD lucido  
Polished N690Co  
HRC 58-60

**MANICO | HANDLE**  
G10 arancione  
Orange G10

**LINER LOCK**  
AISI 420 lucido  
Polished AISI 420

**DISTANZIALE | SPACER**  
AISI 420 lucido  
Polished AISI 420

**CLIP**  
Sagomata AISI 420 black  
idroglied  
Black idroglied shaped  
AISI 420

**VITI | SCREWS**  
AISI 303 black idroglied  
Black idroglied AISI 303

11 cm - 4.33"

4 mm - 0.16"

25 cm - 9.84"

135 g - 4.76 oz



**HECTOR  
FX-504 B**  
FRAME LOCK

**LAMA | BLADE**  
N690Co black idroglied  
Black idroglied N690Co  
HRC 58-60

**MANICO | HANDLE**  
AISI 420 black idroglied  
Black idroglied AISI 420

**LINER LOCK**  
AISI 420 black idroglied  
Black idroglied AISI 420

**DISTANZIALE | SPACER**  
AISI 420 black idroglied  
Black idroglied AISI 420

**CLIP**  
Sagomata in AISI 420  
black idroglied  
Black idroglied shaped  
AISI 420

**VITI | SCREWS**  
AISI 303 black idroglied  
Black idroglied AISI 303

8,5 cm - 3.34"

3 mm - 0.12"

20,2 cm - 7.95"

80 g - 2.82 oz



**IRVES**

designed by Andreas Weitzel

**FX-532**  
LINER LOCK

**LAMA | BLADE**  
N690Co PVD nero  
Black PVD N690Co  
HRC 58-60

**MANICO | HANDLE**  
G10 nero  
Black G10

**LINER LOCK**  
AISI 420 black idroglied  
Black idroglied AISI 420

**DISTANZIALE | SPACER**  
AISI 420 black idroglied  
Black idroglied AISI 420

**CLIP**  
Sagomata in AISI 420 black  
idroglied  
Black idroglied shaped  
AISI 420

**VITI | SCREWS**  
AISI 303 black idroglied  
Black idroglied AISI 303

8,5 cm - 3.35"

4 mm - 0.16"

21,5 cm - 8.46"

250 g - 8.82 oz



**FX-MTF5**  
LINER LOCK

designed by Patrick Nihiser

**LAMA | BLADE**  
N690Co PVD nero  
Black PVD N690Co  
HRC 58-60

**MANICO | HANDLE**  
G10 nero  
Black G10

**LINER LOCK**  
AISI 420 black idroglied  
Black idroglied AISI 420

**DISTANZIALE | SPACER**  
Titanio sabbaiato  
Sandblasted titanium

**CLIP**  
Sagomata in titanio  
sabbaiato  
Sandblasted shaped  
titanium

**VITI | SCREWS**  
AISI 303 rivestito al nichel  
Nickel plated AISI 303

9 cm - 3.54"

3 mm - 0.12"

22 cm - 8.66"

205 g - 7.23 oz

# FX-500 & FX-501 TRACKER FOLDING KNIFE "MESKWAKI"

## FX-500 BACK LOCK



445 g - 15.69 oz



31 cm - 12.20"



5 mm - 0.20"



13.5 cm - 5.31"



Nylon® 1000D con sistema MOLLE - Consente il trasporto del coltello anche da aperto  
Nylon® 1000D with MOLLE system - Enables the knife to be also carried as fixed blade

N690Co sabbiato  
Sandblasted N690Co  
HRC 58-60

Micarta verde  
Green Micarta

AISI 420 sabbiato  
Sandblasted AISI 420

AISI 303 black idrogliider  
Black idrogliider AISI 303

## FX-501 BACK LOCK



445 g - 15.69 oz



31 cm - 12.20"



5 mm - 0.20"



13.5 cm - 5.31"



Nylon® 1000D con sistema MOLLE - Consente il trasporto del coltello anche da aperto  
Nylon® 1000D with MOLLE system - Enables the knife to be also carried as fixed blade

N690Co PVD nero  
Black PVD N690Co  
HRC 58-60

G10 terra  
Earth green G10

AISI 420 black idrogliider  
Black idrogliider AISI 420

AISI 303 black idrogliider  
Black idrogliider AISI 303



## ANUNNAKI FX-505 BACK LOCK



310 g - 10.93 oz



26 cm - 10.24"



5 mm - 0.20"



11 cm - 4.33"



N690Co Top Shield® nero  
Black Top Shield® N690Co  
HRC 58-60

G10 nero  
Black G10

AISI 420 black idrogliider  
Black idrogliider AISI 420

AISI 420 black idrogliider  
Black idrogliider AISI 420

AISI 303 black idrogliider  
Black idrogliider AISI 303

## ANUNNAKI FX-505 GR BACK LOCK



310 g - 10.93 oz



26 cm - 10.24"



5 mm - 0.20"



11 cm - 4.33"



N690Co stone washed  
Stone washed N690Co  
HRC 58-60

G10 grigio  
Grey G10

AISI 420 sabbiato  
Sandblasted AISI 420

AISI 420 lucido  
Polished AISI 420

AISI 303 rivestito al nichel  
Nickel plated AISI 303

## ARURU FX-506 BACK LOCK



300 g - 10.58 oz



26 cm - 10.24"



5 mm - 0.20"



11 cm - 4.33"



N690Co stone washed  
Stone washed N690Co  
HRC 58-60

G10 grigio  
Grey G10

AISI 420 sabbiato  
Sandblasted AISI 420

AISI 420 lucido  
Polished AISI 420

AISI 303 rivestito al nichel  
Nickel plated AISI 303

# FX-626

## KS SHORT

designed by GZ Tactical Knives

### KS

Nato a novembre 2020, il modello KS rappresenta una fusione di esperienza e innovazione. Prende il suo nome da un corso di specializzazione e formazione dell'Esercito Italiano, fondamentale per accedere alla brigata paracadutisti Folgore. Il KS ha una lama compatta e leggera, con un profilo drop point, progettata per facilitare vari tipi di lavorazione. Il manico è comodo e versatile, studiato per garantire una presa sicura anche con la tecnica all'inglese.

Born in November 2020, the KS model represents a fusion of experience and innovation. It takes its name from an Italian Army specialization and training course, essential for entry into the Folgore paratrooper brigade. The KS has a compact, lightweight blade with a drop point profile designed to facilitate various types of work. The handle is comfortable and versatile, designed to provide a secure grip even with the English technique.

### KS SHORT

Dall'esperienza con il modello KS, è nata una versione scheletrizzata, priva di manico e leggermente più corta. Il KS SHORT si rivela un ottimo compagno, progettato per essere trasportato con zero ingombro.

From the experience with the KS model, a skeletonized version was born, without a handle and slightly shorter. The KS SHORT proves to be an excellent companion, designed to be carried with zero bulk.

### MONTESERRA

Prende il nome dal Monte Serra in Toscana, questo coltello è stato concepito per affrontare le sfide della sopravvivenza boschiva, rendendolo ideale per lavori medio/pesanti. Il Monte Serra è noto per essere una delle prove più impegnative per gli aspiranti paracadutisti e non solo, e avere un alleato come questo coltello può fare la differenza nei momenti cruciali. Il profilo della lama è di tipo drop point, il che ne aumenta l'efficacia e la precisione durante l'uso. Inoltre, presenta un fuller sulla lama, progettato per alleggerirla senza compromettere la robustezza. Il manico, sufficientemente lungo, consente di impugnarlo al meglio anche indossando guanti, mentre l'ergonomia dell'impugnatura garantisce un comfort superiore, facilitando la maneggevolezza e il controllo durante qualsiasi operazione. Questo coltello è davvero pensato per affrontare le avventure più impegnative con sicurezza e affidabilità.

Named after Monte Serra in Tuscany, this knife is designed to meet the challenges of forest survival, making it ideal for medium/heavy work. Monte Serra is known to be one of the most challenging trials for aspiring paratroopers and others, and having an ally like this knife can make all the difference in crucial moments.

The blade profile is drop point, which increases its effectiveness and accuracy during use. It also features a fuller on the blade, designed to lighten it without compromising strength. The handle, which is sufficiently long, allows it to be best gripped even while wearing gloves, while the ergonomics of the grip provide superior comfort, facilitating handling and control during any operation. This knife is truly designed to tackle the most challenging adventures with confidence and reliability.

### FX-626

#### FIXED BLADE

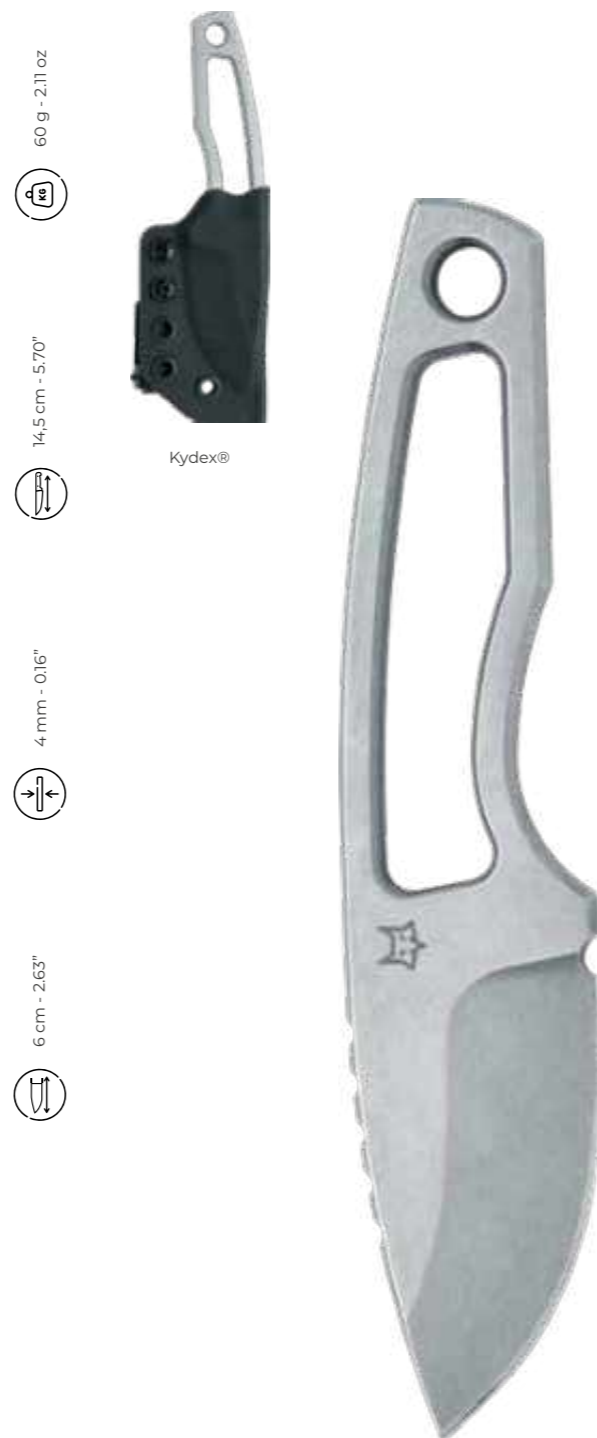

60 g - 2.11 oz



14.5 cm - 5.70"



4 mm - 0.16"



6 cm - 2.63"



Nilox stone washed  
Stone washed Nilox  
HRC 59-61



Kydex®

# FX-627

## KS

designed by GZ Tactical Knives

### FX-627 G10B

#### FIXED BLADE

NEW  
ITEM



142 g - 5.01 oz



18.3 cm - 7.20"



5 mm - 0.20"



8 cm - 3.14"



Nilox antracite Top Shield®  
stone washed  
Stone washed charcoal  
Top Shield® Nilox  
HRC 59-61



G10 nero  
Black G10



AISI 303 black idrogliker  
Black idrogliker AISI 303



Kydex®

### FX-627 G10OD

#### FIXED BLADE

NEW  
ITEM



142 g - 5.01 oz



18.3 cm - 7.20"



5 mm - 0.20"



8 cm - 3.14"



Nilox antracite Top Shield®  
stone washed  
Stone washed charcoal  
Top Shield® Nilox  
HRC 59-61



G10 verde OD  
OD green G10



AISI 303 coyote idrogliker  
Coyote idrogliker AISI 303



Kydex®

# FX-628 MONTESERRA

designed by GZ Tactical Knives

## FX-628 G10B FIXED BLADE

NEW  
ITEM

250 gr - 8.81 oz

23,5 cm - 9.25"

6 mm - 0.23"

11cm - 4.33"

Nilox stone washed  
Stone washed Nilox  
HRC 59-61

G10 nero  
Black G10

AISI 303 lucido  
Polished AISI 303



Kydex®

## FX-628 G10OD FIXED BLADE

NEW  
ITEM

250 gr - 8.81 oz

23,5 cm - 9.25"

6 mm - 0.23"

11cm - 4.33"

Nilox antracite Top Shield®  
stone washed  
Stone washed charcoal  
Top Shield®  
HRC 59-61

G10 verde OD  
OD green G10

AISI 303 coyote idroglied  
Coyote idroglied AISI 303



Kydex®

# FX-647 TACTICAL ELEMENTUM DAGGER



## FX-647 S FIXED BLADE

10 cm - 3.93"    3 mm - 0.12"    20,6 cm - 8.11"    100 gr - 3.53 oz

**LAMA | BLADE**  
N690Co black idroglied  
Black idroglied N690Co  
HRC 58-60

**MANICO | HANDLE**  
PP+TPE nero  
Black PP+TPE



Kydex® con laccio in Nylon® e MOLLE - lock clip  
Kydex® with Nylon® lace and MOLLE - lock clip



Kydex® con laccio in Nylon® e MOLLE - lock clip  
Kydex® with Nylon® lace and MOLLE - lock clip

## FX-647 FIXED BLADE

**LAMA | BLADE**  
N690Co black idroglied  
Black idroglied N690Co  
HRC 58-60

**MANICO | HANDLE**  
PP+TPE nero  
Black PP+TPE

10 cm - 3.93"    5 mm - 0.19"

20,6 cm - 8.11"    100 gr - 3.53 oz



Kydex® con laccio in Nylon® e MOLLE - lock clip  
Kydex® with Nylon® lace and MOLLE - lock clip

## FX-647 AF FIXED BLADE

**LAMA | BLADE**  
N690Co black idroglied  
Black idroglied N690Co  
HRC 58-60

**MANICO | HANDLE**  
PP+TPE nero  
Black PP+TPE

10 cm - 3.93"    5 mm - 0.19"

20,6 cm - 8.11"    100 gr - 3.53 oz

Fox Knives in occasione del centesimo anniversario della fondazione dei reparti d'Assalto, i Gloriosi Arditi (1917-2017), ha riprodotto una rielaborazione del primo modello di pugnale a loro in dotazione, mantenendone la similitudine in una versione attuale con materiali di qualità, unendo così storia ed eccellenza di una produzione italiana in onore dei veri eroi della Grande Guerra, coloro che diedero vita ai primi reparti speciali moderni al Mondo e che furono i primi a specializzare metodi di scherma con il pugnale per il combattimento individuale.

To celebrate the 100th anniversary of the foundation of the Italian Assault units, 'I Gloriosi Arditi' (1917-2017), Fox Knives has made a reproduction of the first model of dagger supplied to them, keeping the similarity in a current modern version made with quality materials, combining history and excellence of Italian production in honor of the real heroes of Great War, those who gave birth to the first modern special forces in the world and the first specialized with the dagger fencing methods for individual combat.

Prof. Antonio G. G. Merendoni



## VELENO FX-596 AF FIXED BLADE

 17,5 cm - 6.73"
  6 mm - 0.24"
  30 cm - 11.81"
  223 g - 7.68 oz

**LAMA | BLADE**  
Top Shield® nero N690Co  
Black Top Shield® N690Co  
HRC 58-60

**MANICO | HANDLE**  
Alluminio nero  
Black aluminium

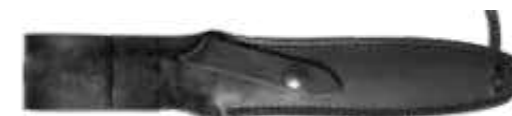

Cuoio nero  
Black leather

**FX-596**  
Versione con lama ad un filo  
Single edge blade version



## VELENO FX-595 WAF FIXED BLADE

 17,5 cm - 6.88"
  4 mm - 0.16"
  29 cm - 11.41"
  211 g - 7.44 oz

**LAMA | BLADE**  
N690Co satinato  
Satin N690Co  
HRC 58-60

**MANICO | HANDLE**  
Ziricote  
Ziricote wood

**VITI | SCREWS**  
AISI 303 lucido  
Polished AISI 303



Cuoio marrone  
Brown leather

**FX-595 W**  
Versione con lama ad un filo  
Single edge blade version

# FX-507 & FX-0171100

## MORDAS & BELLUM DAGA

### MODRAS

designed by Borut Kincl

#### FX-507 AF FIXED BLADE

**FX-507**  
Versione con lama ad un filo  
Single edge blade version



340 g - 11.99 oz



33 cm - 12.99"



6 mm - 0.24"



17,5 cm - 6.88"



Cuoio nero  
Black leather

N690Co black idroglider  
Black idroglider N690Co  
HRC 58-60

G10 nero  
Black G10

AISI 303 black idroglider  
Black idroglider AISI 303

### BELLUM DAGA

designed by Gabriel A. Serman

#### FX-0171100 AF FIXED BLADE

**FX-0171100**  
Versione con lama ad un filo  
Single edge blade version



275 g - 9.70 oz



32,5 cm - 12.79"



6 mm - 0.24"



17,5 cm - 6.88"



Nylon® e Kydex® con  
sistema MOLLE  
Nylon® and Kydex® with  
MOLLE system

N690Co black idroglider  
Black idroglider N690Co  
HRC 58-60

G10 nero  
Black G10

AISI 303 rivestito al Nichel  
Nickel plated AISI 303

# FX-689

## DEFENDER



### FX-689 B FIXED BLADE



17,3 cm - 6.81"



5 mm - 0.19"



32 cm - 12.50"



350 gr - 12.35 oz

#### LAMA | BLADE

Top Shield® nero N690Co  
Black Top Shield® N690Co  
HRC 58-60

#### MANICO | HANDLE

FRN nero + guardia AISI 420 black  
idroglider + pomolo AISI 303 black  
idroglider  
Black FRN + black idroglider AISI  
420 guard + black idroglider AISI  
303 pommel



Kydex®

### FX-689 FIXED BLADE



17,3 cm - 6.81"



5 mm - 0.19"



32 cm - 12.50"



350 gr - 12.35 oz

#### LAMA | BLADE

N690Co sabbaiato  
Sandblasted N690Co  
HRC 58-60

#### MANICO | HANDLE

Noce + guardia AISI 420 sabbaiato +  
pomolo AISI 303 sabbaiato  
Walnut wood + sandblasted AISI  
420 guard + sandblasted AISI 420  
pommel



Cuoio nero  
Black leather



Nylon® con sistema MOLE  
Nylon® with MOLLE system



Nylon® con sistema MOLE  
Nylon® with MOLLE system



Nylon® con sistema MOLE  
Nylon® with MOLLE system  
+  
Kit di sopravvivenza incluso nel fodero  
Survival kit included with the sheath



Nylon® con sistema MOLE  
Nylon® with MOLLE system  
+  
Kit di sopravvivenza incluso nel fodero  
Survival kit included with the sheath



Nylon® con sistema MOLE  
Nylon® with MOLLE system



Nylon®

**RIMOR  
FX-9CM07  
FIXED BLADE**

360 g - 12.69 oz



30,5 cm - 12.00"



6 mm - 0.24"



17,5 cm - 6.88"



**RIMOR  
FX-9CM07 OD  
FIXED BLADE**

360 g - 12.69 oz



30,5 cm - 12.00"



6 mm - 0.24"



17,5 cm - 6.88"



**PARANG  
FX-0107153  
FIXED BLADE**

340 g - 11.99 oz



30 cm - 11.81"



6 mm - 0.24"



17 cm - 6.69"



**PARUS  
FX-9CM06  
FIXED BLADE**

340 g - 11.99 oz



30 cm - 11.81"



6 mm - 0.24"



17,5 cm - 6.88"



**TRACKER  
FX-9CM01 B  
FIXED BLADE**

310 g - 10.93 oz



28,5 cm - 11.22"



6 mm - 0.24"



15 cm - 5.90"



**GOLOK HITAM  
FX-9CM02B  
FIXED BLADE**

385 g - 13.58 oz



36 cm - 14.17"



6 mm - 0.24"



22,5 cm - 8.85"



N690Co stone washed  
Stone washed N690Co  
HRC 58-60

Forprene® nero  
Black Forprene®

AISI 303 rivestito al Nichel  
Nickel plated AISI 303

N690Co black idrogliker  
Black idrogliker N690Co  
HRC 58-60

Forprene® verde OD  
OD green Forprene®

AISI 303 rivestito al Nichel  
Nickel plated AISI 303

N690Co Top Shield®  
Top Shield® N690Co  
HRC 58-60

Forprene® coyote tan  
Coyote tan Forprene®

AISI 303 rivestito al Nichel  
Nickel plated AISI 303

N690Co black idrogliker  
Black idrogliker N690Co  
HRC 58-60

Forprene® nero  
Black Forprene®

AISI 303 rivestito al Nichel  
Nickel plated AISI 303

N690Co PVD nero  
Black PVD N690Co  
HRC 58-60

Forprene® verde OD  
OD green Forprene®

AISI 303 rivestito al Nichel  
Nickel plated AISI 303

N690Co PVD grigio  
Grey PVD N690Co  
HRC 58-60

Forprene® nero  
Black Forprene®

AISI 303 rivestito al Nichel  
Nickel plated AISI 303



Kydex®

**VENGEANCE**

designed by Jerry Hossom

**FX-601**  
FIXED BLADE

**LAMA | BLADE**  
N690Co sabbaiato  
Sandblasted N690Co  
HRC 58-60

**MANICO | HANDLE**  
Micarta verde  
Green Micarta

**VITI | SCREWS**  
AISI 304 lucido  
Polished AISI 304

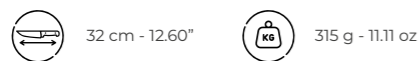
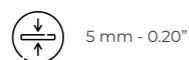

Nylon®

**O.M.G. KAIMANO**

**OMG-1**  
FIXED BLADE

**LAMA | BLADE**  
N690Co PVD nero  
Black PVD N690Co  
HRC 58-60

**MANICO | HANDLE**  
Forprene® nero + elsa AISI 420  
black idrogliider  
Black Forprene® + black idrogliider  
AISI 420 pommel

**VITI | SCREWS**  
AISI 304 rivestito al Nichel  
Nickel plated AISI 304

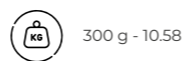
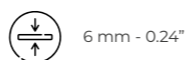

Nylon®

**PREDATOR I**

**FX-P1M**  
FIXED BLADE

**LAMA | BLADE**  
N690Co MilSpec  
MilSpec N690Co  
HRC 58-60

**MANICO | HANDLE**  
Forprene® verde  
Green Forprene®

**VITI | SCREWS**  
AISI 304 rivestito al Nichel  
Nickel plated AISI 304

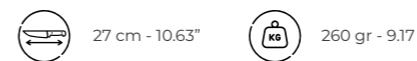

Nylon®

**PREDATOR I**

**FX-P1DC**  
FIXED BLADE

**LAMA | BLADE**  
N690Co desert camo idrogliider  
Desert camo Idrogliider N690Co  
HRC 58-60

**MANICO | HANDLE**  
Forprene® verde  
Green Forprene®

**VITI | SCREWS**  
AISI 304 rivestito al Nichel  
Nickel plated AISI 304

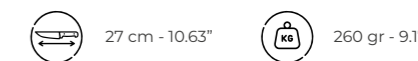

Nylon®

**PREDATOR**

**FX-G2B**  
FIXED BLADE

**LAMA | BLADE**  
N690Co black idrogliider  
Black idrogliider N690Co  
HRC 58-60

**MANICO | HANDLE**  
Forprene® nero  
Black Forprene®

**VITI | SCREWS**  
AISI 304 rivestito al Nichel  
Nickel plated AISI 304

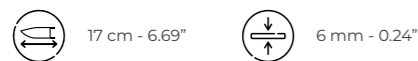

Nylon®

**PREDATOR**

**FX-P3B**  
FIXED BLADE

**LAMA | BLADE**  
N690Co black idrogliider  
Black idrogliider N690Co  
HRC 58-60

**MANICO | HANDLE**  
Forprene® nero  
Black Forprene®

**VITI | SCREWS**  
AISI 304 rivestito al Nichel  
Nickel plated AISI 304

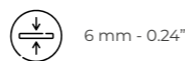

Nylon®

**N.E.R.O.**

**FX-NR01 TT**  
FIXED BLADE

**LAMA | BLADE**  
N690Co black idrogliider  
Black idrogliider N690Co  
HRC 58-60

**MANICO | HANDLE**  
G10 nero  
Black G10

**VITI | SCREWS**  
AISI 304 rivestito al Nichel  
Nickel plated AISI 304

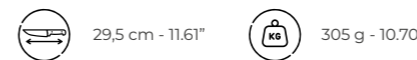
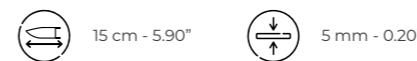

Nylon®

**N.E.R.O.**

**FX-NR03 CUC**  
FIXED BLADE

**LAMA | BLADE**  
N690Co urban winter camo  
Urban winter camo N690Co  
HRC 58-60

**MANICO | HANDLE**  
G10 urban winter camo  
Urban winter camo G10

**VITI | SCREWS**  
AISI 304 rivestito al Nichel  
Nickel plated AISI 304





Kydex® e Nylon® MOLLE +  
MOLLE-lock clip  
Kydex® and Nylon® MOLLE  
system and MOLLE-lock clip

### SPEAR TECH FX-0171112 FIXED BLADE

**LAMA | BLADE**  
N690Co black idroglied  
Black idroglied N690Co  
HRC 58-60

**MANICO | HANDLE**  
G10 nero  
Black G10

**VITI | SCREWS**  
AISI 303 rivestito al Nichel  
Nickel plated AISI 303

15 cm - 5.90"

6 mm - 0.24"

28 cm - 11.02"

305 g - 10.75 oz



Nylon® 1000D MOLLE +  
FRN®  
1000D Nylon® MOLLE system  
+ FRN®

### SPARTAN SF-DB03 FIXED BLADE

**LAMA | BLADE**  
N690Co black idroglied  
Black idroglied N690Co  
HRC 58-60

**MANICO | HANDLE**  
Forprene® verde OD + elsa  
AISI 420 black idroglied  
OD green Forprene® + black  
idroglied AISI 420 pommel

18,5 cm - 7.28"

6 mm - 0.24"

32,5 cm - 12.79

390 g - 13.75 oz



Nylon® 1000D MOLLE +  
FRN®  
1000D Nylon® MOLLE system  
+ FRN®

### SPARTAN FX-3005 FIXED BLADE

**LAMA | BLADE**  
N690Co Mil Spec nero  
Black Mil Spec N690Co  
HRC 58-60

**MANICO | HANDLE**  
Forprene® nero + elsa  
AISI 420 black idroglied  
Black Forprene® + black  
idroglied AISI 420 pommel

18,5 cm - 7.28"

6 mm - 0.24"

32,5 cm - 12.79

390 g - 13.75 oz



Nylon® 1000D con sistema MOLLE  
Nylon® 1000D with MOLLE system

### TARANIS FX-0171115 FIXED BLADE

304 g - 10.72 oz



32 cm - 12.60"



5 mm - 0.20"



18,5 cm - 7.28"



N690Co cotole tan idroglied  
Coyote tan idroglied N690Co  
HRC 58-60

Forprene® coyote tan  
Coyote tan Forprene®



Nylon® 1000D con sistema MOLLE  
Nylon® 1000D with MOLLE system

### TARANIS FX-0171114 FIXED BLADE

304 g - 10.72 oz



32 cm - 12.60"



5 mm - 0.20"



18,5 cm - 7.28"



N690Co black idroglied  
Black idroglied N690Co  
HRC 58-60

Forprene® nero  
Black Forprene®



Kydex® con MOLLE - Lock clip  
Kydex® with MOLLE - Lock clip

### FIRE BRIGADE FX-0171102 FIXED BLADE

225 g - 7.93 oz



27,5 cm - 10.82"



5 mm - 0.20"



13,5 cm - 5.31"



N690Co black idroglied  
Black idroglied N690Co  
HRC 58-60

Forprene® verde OD  
OD green Forprene®



Nylon® 1000D MOLLE +  
FRN®  
1000D Nylon® MOLLE system  
+ FRN®

### AREX SPARTAN SF-F2000 FIXED BLADE

**LAMA | BLADE**  
AISI 440 black idroglied  
Black idroglied AISI 440  
HRC 55-57

**MANICO | HANDLE**  
Forprene® nero + elsa  
AISI 420 black idroglied  
Black Forprene® + black  
idroglied AISI 420 pommel

Incluso / Included:  
Piastra taglia fili e pietra per riaffilare la  
lama / Wire cutting plate and diamond  
stone for sharpening

18,5 cm - 7.28"

5 mm - 0.19"

32,5 cm - 12.79

345 g - 12.16 oz



Nylon® 1000D MOLLE +  
FRN®  
1000D Nylon® MOLLE system  
+ FRN®

### AREX SPARTAN SF-F2000 FN FIXED BLADE

**LAMA | BLADE**  
AISI 440 black idroglied  
Black idroglied AISI 440  
HRC 55-57

**MANICO | HANDLE**  
Forprene® nero + elsa AISI 420  
black idroglied  
Black Forprene® + black  
idroglied AISI 420 pommel

Incluso / Included:  
Piastra taglia fili e pietra per riaffilare la  
lama / Wire cutting plate and diamond  
stone for sharpening

18,5 cm - 7.28"

5 mm - 0.19"

32,5 cm - 12.79

345 g - 12.16 oz



Nylon® con sistema MOLLE  
Nylon® with MOLLE system

### TECNO MILITARY 3 641/11FNK FIXED BLADE

**LAMA | BLADE**  
N690Co black idroglied  
Black idroglied N690Co  
HRC 58-60

**MANICO | HANDLE**  
PP + gomma sovrastampata +  
elsa AISI 420 black idroglied  
PP + over molding rubber  
+ black idroglied AISI 420  
pommel

**NATO**  
NSN 1095-14-555-6848

11 cm - 4.33"

4 mm - 0.16"

24 cm - 9.44"

165 g - 5.82 oz



N690Co cotole tan idroglied  
Coyote tan idroglied N690Co  
HRC 58-60

Forprene® coyote tan  
Coyote tan Forprene®



N690Co black idroglied  
Black idroglied N690Co  
HRC 58-60

Forprene® nero  
Black Forprene®



N690Co black idroglied  
Black idroglied N690Co  
HRC 58-60

Forprene® verde OD  
OD green Forprene®



Kydex® con MOLLE - Lock clip  
Kydex® with MOLLE - Lock clip

### SERVATOR FX-0171101 B FIXED BLADE

**LAMA | BLADE**  
N690Co black idrogliker  
Black idrogliker N690Co  
HRC 58-60

**MANICO | HANDLE**  
Forprene® nero  
Black Forprene®

 13,5 cm - 5.31"

 5 mm - 0.20"

 27,5 cm - 10.83"

 245 g - 8.64 oz



Nylon® 1000D con sistema  
MOLLE e sede in FRN® 1000D Nylon® with  
MOLLE system and FRN® sleeve

### LEONIDA FX-0171106 FIXED BLADE

**LAMA | BLADE**  
N690Co black idrogliker  
Black idrogliker N690Co  
HRC 58-60

**MANICO | HANDLE**  
Forprene® verde OD  
OD green Forprene®

Incluso / Included:  
Piastra taglia fili e pietra per riaffilare  
la lama / Wire cutting plate and  
diamond stone for sharpening

 18,5 cm - 7.28"

 5 mm - 0.20"

 31 cm - 12.20"

 285 g - 10.05 oz



Nylon® 1000D con sistema  
MOLLE e sede in FRN® 1000D Nylon® with  
MOLLE system and FRN® sleeve

### LEONIDA FX-0171107 FIXED BLADE

**LAMA | BLADE**  
N690Co black idrogliker  
Black idrogliker N690Co  
HRC 58-60

**MANICO | HANDLE**  
Forprene® nero  
Black Forprene®

Incluso / Included:  
Piastra taglia fili e pietra per riaffilare  
la lama / Wire cutting plate and  
diamond stone for sharpening

 18,5 cm - 7.28"

 5 mm - 0.20"

 31 cm - 12.20"

 285 g - 10.05 oz



Nylon® 1000D con sistema  
MOLLE e sede in FRN®  
1000D Nylon® with MOLLE  
system and FRN® sleeve

### OPLITA FX-0171116 FIXED BLADE

**LAMA | BLADE**  
N690Co coyote tan idrogliker  
Coyote tan idrogliker N690Co  
HRC 58-60

**MANICO | HANDLE**  
Karton G® coyote tan  
Coyote tan Karton G

Incluso / Included:  
Piastra taglia fili e pietra per riaffilare la lama / Wire cutting plate  
and diamond stone for sharpening

 18,5 cm - 7.28"  5 mm - 0.20"

 31 cm - 12.20"  360 g - 12.69 oz



Nylon® 1000D con sistema  
MOLLE e sede in FRN®  
1000D Nylon® with MOLLE  
system and FRN® sleeve

### OPLITA FX-0171117 FIXED BLADE

**LAMA | BLADE**  
N690Co black idrogliker  
Black idrogliker N690Co  
HRC 58-60

**MANICO | HANDLE**  
Karton G® nero  
Black Karton G®

Incluso / Included:  
Piastra taglia fili e pietra per riaffilare la lama / Wire cutting plate  
and diamond stone for sharpening

 18,5 cm - 7.28"  5 mm - 0.20"

 31 cm - 12.20"  360 g - 12.69 oz



Nylon® 1000D con sistema  
MOLLE e sede in FRN®  
1000D Nylon® with MOLLE  
system and FRN® sleeve

### LEONIDA FX-0193000 FIXED BLADE

**LAMA | BLADE**  
N690Co black idrogliker  
Black idrogliker N690Co  
HRC 58-60

**MANICO | HANDLE**  
Forprene® verde OD + elsa AISI 420 black idrogliker  
OD green Forprene® + black idrogliker AISI 420  
pommel

Incluso / Included:  
Piastra taglia fili e pietra per riaffilare la lama / Wire cutting  
plate and diamond stone for sharpening

 18,5 cm - 7.28"  5 mm - 0.20"

 31 cm - 12.20"  285 g - 10.05 oz



Nylon® 1000D con sistema  
MOLLE e sede in FRN®  
1000D Nylon® with MOLLE  
system and FRN® sleeve



### LEONIDA FX-0193001 FIXED BLADE

**LAMA | BLADE**  
N690Co black idrogliker  
Black idrogliker N690Co  
HRC 58-60

**MANICO | HANDLE**  
Forprene® nero + elsa AISI 420 black idrogliker  
Black Forprene® + black idrogliker AISI 420  
pommel

Incluso / Included:  
Piastra taglia fili e pietra per riaffilare la lama / Wire cutting  
plate and diamond stone for sharpening

 18,5 cm - 7.28"  5 mm - 0.20"

 31 cm - 12.20"  285 g - 10.05 oz



Nylon® 1000D con sistema  
MOLLE e sede in FRN®  
1000D Nylon® with MOLLE  
system and FRN® sleeve

### OPLITA FX-3003 FIXED BLADE

**LAMA | BLADE**  
N690Co coyote tan idrogliker  
Coyote tan idrogliker N690Co  
HRC 58-60

**MANICO | HANDLE**  
Karton G® coyote tan  
Coyote tan Karton G

Incluso / Included:  
Piastra taglia fili e pietra per riaffilare la lama / Wire cutting plate  
and diamond stone for sharpening

 18,5 cm - 7.28"  5 mm - 0.20"

 31 cm - 12.20"  360 g - 12.69 oz



Nylon® 1000D con sistema  
MOLLE e sede in FRN®  
1000D Nylon® with MOLLE  
system and FRN® sleeve

### OPLITA FX-3002 FIXED BLADE

**LAMA | BLADE**  
N690Co black idrogliker  
Black idrogliker N690Co  
HRC 58-60

**MANICO | HANDLE**  
Karton G® nero  
Black Karton G®

Incluso / Included:  
Piastra taglia fili e pietra per riaffilare la lama / Wire cutting plate  
and diamond stone for sharpening

 18,5 cm - 7.28"  5 mm - 0.20"

 31 cm - 12.20"  360 g - 12.69 oz



Nylon® 1000D con sistema MOLLE  
Nylon® 1000D with MOLLE system



Nylon® 1000D con sistema MOLLE  
Nylon® 1000D with MOLLE system



Nylon® 1000D con sistema MOLLE  
Nylon® 1000D with MOLLE system

**EXTREME TACTICAL**

designed by Boris Sterm

**FX-9CM04 T**  
FIXED BLADE

450 g - 15.87



36,5 cm - 14.37"



6 mm - 0.24"



23,5 cm - 9.25"



N690Co black idrogliker  
Black idrogliker N690Co  
HRC 58-60

Forprene® nero  
Black Forprene®

AISI 303 rivestito al Nichel  
Nickel plated AISI 303

**EXTREME TACTICAL**

designed by Boris Sterm

**FX-9CM04 BT**  
FIXED BLADE

450 g - 15.87



36,5 cm - 14.37"



6 mm - 0.24"



23,5 cm - 9.25"



N690Co coyote tan idrogliker  
Coyote tan idrogliker N690Co  
HRC 58-60

Forprene® verde OD  
OD green Forprene®

AISI 303 rivestito al Nichel  
Nickel plated AISI 303

**EXTREME TACTICAL**

designed by Boris Sterm

**FX-9CM05 T**  
FIXED BLADE

450 g - 15.87



36,5 cm - 14.37"



6 mm - 0.24"



23,5 cm - 9.25"



N690Co black idrogliker  
Black idrogliker N690Co  
HRC 58-60

Forprene® nero  
Black Forprene®

AISI 303 rivestito al Nichel  
Nickel plated AISI 303

**FX-MIR115/2 VVF**  
OFFICIAL ISSUE ITALIAN FIRE BRIGADE AXE

930 g - 35.27 oz



41 cm - 16.14"



20 - 3 mm | 0.78 - 0.12"



72 cm - 2.83"



Cuoio nero  
Black leather

Acciaio al carbonio C70 satinato  
Satin C70 carbon steel  
HRC 50-52

Frassino verniciato  
Painted Ash wood

L'Official Issue Italian Fire Brigade Axe è una piccozza specificamente progettata per l'uso da parte dei vigili del fuoco italiani. Questo strumento rappresenta uno degli strumenti essenziali nel kit di attrezzature di un vigile del fuoco e svolge un ruolo cruciale durante le operazioni di emergenza e di soccorso.

Presenta un'estremità affilata che può essere utilizzata per penetrare attraverso materiali come legno, plastica o metallo. Questo è utile per aprire porte bloccate, rompere finestre o scavare attraverso detriti durante le operazioni di ricerca e soccorso.

L'altra estremità della piccozza può avere una lama affilata per tagliare materiali più morbidi o un'estremità appuntita per penetrare attraverso materiali più duri.

The Official Issue Italian Fire Brigade Axe is a axe specifically designed for use by Italian firefighters. This tool represents one of the essential tools in a firefighter's equipment kit and plays a crucial role during emergency and rescue operations.

It features a sharp end that can be used to penetrate materials such as wood, plastic, or metal. This is useful for opening blocked doors, breaking windows, or digging through debris during search and rescue operations. The other end of the axe may have a sharp blade for cutting softer materials or a pointed end for penetrating harder materials.

# FX-0171111 PALA DA CAMPO | FOLDING SPADE



1,245 g - 43,91 oz

60 cm - 23,62"

tot

FX-0171111



FX-0171111 B

 AISI 420 black idrogliker  
Black idrogliker AISI 420  
HRC 54-56

 Chiudibile brevettato in FRN® + alluminio  
Folding handle patent system FRN® +  
aluminium

NATO  
NSN 5120-15-205-0607

**Caratteristiche principali - Key features:**

- Manico pieghevole / Folding handle
- Minimo ingombro / Minimum dimensions
- Tre diversi angoli di lavoro della pala: 90°, 135° e 180° rispetto al manico / Three different working angles of the shovel: 90°, 135° and 180° to the handle

- Robusta e leggera la pala pieghevole FKMD può essere facilmente trasportata in uno zaino, sotto il sedile dell'auto, in una barca, ovunque lo spazio sia limitato / FKMD folding spade is strong and light, it stores in tight spaces for easy transport in a backpack, in a boat, anywhere space is limited

# FX-MP01 TI KIT KIT SONDA MINE | MINE PROBE KIT

Attrezzo multiuso NON incluso nel kit  
E.O.D. tool NOT included



**Caratteristiche principali - Key features:**

- Manico pieghevole / Folding handle
- Minimo ingombro / Minimum dimensions
- Tre diversi angoli di lavoro della pala: 90°, 135° e 180° rispetto al manico / Three different working angles of the shovel: 90°, 135° and 180° to the handle
- Robusta e leggera la pala pieghevole FKMD può essere facilmente trasportata in uno zaino, sotto il sedile dell'auto, in una barca, ovunque lo spazio sia limitato / FKMD folding spade is strong and light, it stores in tight spaces for easy transport in a backpack, in a boat, anywhere space is limited

NATO  
NSN 5120-15-205-0607

**FX-MP01 TI KIT EOD**

Attrezzo multiuso incluso nel kit  
E.O.D. tool included

tot 76 cm - 29,92" 590 g - 20,81oz



676

AISI 420  
HRC 55-57

Polipropilene PP-EP nero  
Black Polypropylene PP-PE

140 g - 4,93 oz



FX-0107153/1SK

14 x 9 x 3 cm - 5,51" x 3,54" x 1,18"



FIRE STARTER  
EX-001620-BLK

# SOG MULTIUSO - MULTIPURPOSE



## POWER ACCESS SOG PA1001-CP

### STRUMENTI | TOOLS

- Pinze / Pliers
- Pinze a serraggio / Grip pliers
- Coltello / Knife
- Tagliafili morbido / Wire cutters soft
- Tagliafili duro / Wire cutters hard
- Apriscatole / Can opener
- Apribottiglie / Bottle opener
- Piccolo cacciavite piatto / Small flat screwdriver
- Cacciavite medio a lama piatta / Medium flat screwdriver
- Cacciavite a punta grande piatta / Large flat screwdriver
- Cacciavite a croce / Phillips screwdriver
- Lima / File
- Punteruolo / Awl
- Righello / Ruler
- Goniometro / Protractor
- Portainseri magnetico / Magnetic bit holder

21,0 cm - 8.26"

167 g - 5.90 oz



## POWER ACCESS DELUXE SOG PA2001-CP

### STRUMENTI | TOOLS

- Pinze / Pliers
- Tranciafili / Wire cutters
- Coltello / Knife
- Coltello seghettato / Serrated knife
- Righello / Ruler
- Apriscatole / Can opener
- Cacciavite piccolo / Small screwdriver
- 2 cacciaviti a croce / 2 Phillips screwdriver
- Apribottiglie / Bottle opener
- Cacciavite medio / Medium screwdriver
- Sega / Saw
- Scalpello / Chisel
- Punteruolo / Awl
- Righello / Ruler
- Lima / File
- Pinze per cavi / Wire pliers
- Pinze a serraggio / Grip pliers
- Bussola / Compass
- Portainseri magnetico / Magnetic bit holder

17,2 cm - 6.80"

345 g - 12.16 oz



## POWER LITRE SOG PL1001-CP

### STRUMENTI | TOOLS

- Pinze / Pliers
- Punteruolo / Awl
- Coltello / Knife
- Apribottiglie / Bottle opener
- Apriscatole / Can opener
- Cavatappi / Corkscrew
- Piccolo cacciavite piatto / Small flat screwdriver
- Cacciavite a croce / Phillips screwdriver
- Taglia fili grosso / Hard wire cutter
- Goniometro / Protractor
- Righello / Ruler
- Forbici / Scissors
- Taglierina a filo duro / Hard wire cutter
- Taglierina morbida / Wire cutter soft



12,7 cm - 5.00"

130 g - 4.60 oz



## POWER ASSIST SOG 182/B66

### STRUMENTI | TOOLS

- Pinze / Pliers
- Crimpatore / Crimper
- Tranciafili / Wire cutter
- Placca di protezione utensili removibile / Removable handle cover
- Cacciavite a croce / Phillips screwdriver
- Apribottiglie / Bottle opener
- Piccolo cacciavite piatto / Small flat screwdriver
- Crimpatore / Crimper
- Seghetto / Saw
- Apriscatole / Can opener
- Lama V cut / V cut blade
- Coltello a croce / Phillips screwdriver
- Coltello seghettato / Serrated knife



17,8 cm - 7.00"

265 g - 9.34oz

## POWER PINT SOG PP1001-CP

### STRUMENTI | TOOLS

- Pinze / Pliers
- Taglia fili grosso / Hard wire cutter
- Taglia fili sottile / Soft wire cutter
- Coltello / Knife
- Forbice / Scissor
- Seghetto / Saw
- Lima / File
- Cacciavite a croce / Phillips screwdriver
- Punteruolo / Awl
- Apri scatole / Can opener
- Apri bottiglie / Bottle opener
- Cacciavite a lama piatta / Flat screwdriver
- Scalpello / Chisel
- Righello / Ruler
- Goniometro / Protractor
- Porta punta esagonale magnetico / Magnetic hex bit holder



17,0 cm - 6.69"

119 g - 4.20 oz



## POWER ASSIST EOD SOG 182/B66 EOD

### STRUMENTI | TOOLS

- Pinze / Pliers
- Crimpatore / Crimper
- Tranciafili / Wire cutter
- Placca di protezione utensili removibile / Removable handle cover
- Cacciavite a croce / Phillips screwdriver
- Apri bottiglie / Bottle opener
- Piccolo cacciavite piatto / Small flat screwdriver
- Crimpatore / Crimper
- Seghetto / Saw
- Apriscatole / Can opener
- Lama V cut / V cut blade
- Coltello / Knife
- Coltello seghettato / Serrated knife



17,8 cm - 7.00"

265 g - 9.34oz



## **COLTELLI CHIUDIBILI FOLDING KNIVES**

I coltelli chiudibili di Viper combinano eleganza, innovazione e funzionalità. Le lame, realizzate in acciai di alta qualità, garantiscono eccellente resistenza all'usura e un'affilatura duratura. I meccanismi di apertura fluidi e sicuri, uniti a sistemi di blocco affidabili, assicurano praticità e stabilità nell'uso. Le impugnature, in materiali pregiati come titanio, fibra di carbonio, micarta e legno, offrono ergonomia e ottima presa. Ideali per l'uso quotidiano e le attività outdoor, ma anche da collezione, i coltelli chiudibili Viper rappresentano il perfetto equilibrio tra design raffinato, prestazioni e robustezza.

Viper folding knives combine elegance, innovation, and functionality. The blades, made from high-quality steels, offer excellent wear resistance and long-lasting sharpness. Smooth and secure opening mechanisms, along with reliable locking systems, ensure practicality and stability in use. Handles crafted from premium materials such as titanium, carbon fiber, micarta and wood provide excellent ergonomics and a firm grip. Ideal for everyday carry and outdoor activities but also for collection, Viper folding knives strike the perfect balance between refined design, performance, and durability.

# ALFA



designed by Simone Tonolli



## COLTELLO CHIUDIBILE FOLDING KNIFE

### ADVANCED BACK LOCK





-  Magnacut
-  HRC 62-64
-  AISI 420 stone washed  
Stone washed AISI 420
-  AISI 420 sabbiato  
Sandblasted AISI 420
-  AISI 303 sabbiato  
Sandblasted AISI 303
-  A filo in AISI 420 sabbiato  
Sandblasted wire clip AISI 420

-  7 cm - 2.75"
-  17 cm - 6.69"
-  3 mm - 0.12"
-  100 g - 3.52 oz

## COLTELLO CHIUDIBILE FOLDING KNIFE

### A.S.L.S.

-  M390
-  HRC 59-61
-  AISI 420 sabbiato  
Sandblasted AISI 420
-  Titanio sabbiato  
Sandblasted titanium
-  AISI 303 sabbiato  
Sandblasted AISI 303
-  Sagomata in titanio sabbiato  
Sandblasted shaped titanium

-  9,5 cm - 3 3/4"
-  22,3 cm - 8 3/4"
-  4 mm - 0.16"
-  158 g - 5.57 oz



# Safe

designed by Fabrizio Silvestrelli



## SATINATA | SATIN

**V6020TI3DBL** Manico in titanio con texture anodizzata blu  
Titanium handle with blue anodized texture



**V6020FC** Manico in fibra di carbonio  
Carbon fiber handle



**V6020GB** Manico in C10 nero  
Black C10 handle



## STONE WASHED

**V6022CG** Manico in Micarta verde  
Green Micarta handle



## SATINATA | SATIN

**V6018FC3D** Manico in fibra di carbonio con lavorazione 3D  
Carbon fiber handle with 3D machining



**V6018BC3D** Manico in bocote con lavorazione 3D  
Bocote handle with 3D machining



## STONE WASHED

**V6016IM3D** Manico in iuta Micarta marrone con lavorazione 3D  
Brown burlap Micarta handle with 3D machining



**V6016CG3D** Manico in Micarta verde con lavorazione 3D  
Green Micarta handle with 3D machining







# ONIRO





designed by Denis Simonutti



## COLTELLO CHIUDIBILE FOLDING KNIFE

### CROSS-BAR



-  Magnacut
-  62-64
-  AISI 420 sabbato  
Sandblasted AISI 420
-  AISI 303 sabbato  
Sandblasted AISI 303
-  Sagomata in titanio sabbato  
Sandblasted shaped titanium

-  8,1 cm - 3 1/16"
-  10,2 cm - 4"
-  4 mm - 0.16"
-  106 g - 3.74 oz

## COLTELLO CHIUDIBILE FOLDING KNIFE

### BUTTON LOCK

-  Magnacut
-  62-64
-  AISI 420 temperato  
Tempered AISI 420
-  Titanio sabbato  
Sandblasted titanium
-  AISI 303 sabbato  
Sandblasted AISI 303
-  Sagomata in titanio sabbato  
Sandblasted shaped titanium

-  7,5 cm - 2 15/16"
-  20 cm - 8"
-  4 mm - 0.16"
-  140 g - 4.94 oz

# MOON

designed by Fabrizio Silvestrelli



## SATINATA | SATIN

### V6014FCG

Manico in fibra di carbonio Dark Matter oro by Fatcarbon®  
Gold Dark Matter by Fatcarbon® carbon fiber handle



## STONE WASHED

### V6012IM

Manico in luta Micarta marrone  
Brown burlap Micarta handle



### V6012CG

Manico in Micarta verde  
Green Micarta handle



### V6012UT

Manico in ULTEM™  
ULTEM™ handle



## SATINATA | SATIN

### V6008FCV

Manico in fibra di carbonio Dark Matter verde by Fatcarbon®  
Green Dark Matter by Fatcarbon® carbon fiber handle



### V6008FCM

Manico in fibra di carbonio Dark Matter nero by Fatcarbon®  
Black Dark Matter by Fatcarbon® carbon fiber handle

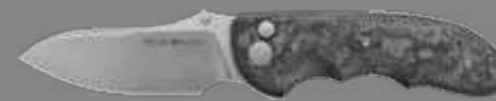

## STONE WASHED

### V6010GG

Manico in Suretouch™ nero  
Black Suretouch™ handle



### V6010TE

Manico in Micarta verde acqua  
Teal Micarta handle



### V6010GR

Manico in G10 borgogna  
Burgundy G10 handle













# vale

designed by Jesper Voxnæs



COLTELLO CHIUDIBILE  
FOLDING KNIFE

LINER LOCK

-  Magnacut
-  62-64
-  AISI 420 sabbato  
Sandblasted AISI 420
-  Titanio sabbato o titanio anodizzato  
bronzo o blu o viola  
Sandblasted titanium or anodized  
bronze or blue or purple titanium
-  AISI 303 sabbato  
Sandblasted AISI 303
-  Sagomata in titanio sabbato o  
sagomata in titanio anodizzato  
bronzo o blu o viola  
Sandblasted shaped titanium or  
anodized bronze or blue or purple  
shaped titanium
-  6,8 cm - 2 2/8"
-  18,4 cm - 7 1/4"
-  4 mm - 0.16"
-  108-147 g - 3.8-5.19 oz



## DARK STONE WASHED

**V6007DTBL**

Manico in titanio dark stone washed  
Dark stone washed titanium handle



## SATINATA | SATIN

**V6004NO**

Manico in noce  
Walnut wood handle



**V6004BC**

Manico in bocote  
Bocote wood handle



## STONE WASHED

**V6006FCP**

Manico in fibra di carbonio Dark Matter  
viola by Fatcarbon®  
Purple Dark Matter by Fatcarbon®  
carbon fiber handle



**V6006GG**

Manico in Suretouch™ nero  
Black Suretouch™ handle



**V6006CV**

Manico in Micarta verde  
Green Micarta handle



# Katla

designed by Jesper Voxnæs



## COLTELLO CHIUDIBILE FOLDING KNIFE

### LINER LOCK







-  Damasco SSCT  
SSCT damascus
-  HRC 58-60
-  AISI 420 sabbiato  
Sandblasted AISI 420
-  Damasco SSCT  
SSCT damascus
-  AISI 303 sabbiato  
Sandblasted AISI 303
-  Sagomata in titanio sabbiato  
Sandblasted shaped titanium

-  8,2 cm - 3 1/8"
-  19,8 cm - 7 3/4"
-  4 mm - 0.16"
-  107 g - 3.77 oz

## COLTELLO CHIUDIBILE FOLDING KNIFE

### LINER LOCK

-  M390
-  HRC 59-61
-  AISI 420 sabbiato  
Sandblasted AISI 420
-  Bronzo sabbiato  
Sandblasted bronze
-  AISI 303 sabbiato  
Sandblasted AISI 303
-  Sagomata in titanio sabbiato  
Sandblasted shaped titanium

-  8,2 cm - 3 1/8"
-  19,8 cm - 7 3/4"
-  4 mm - 0.16"
-  107 g - 3.77 oz (CB-CG)
-  105 g - 3.70 oz (FC- FCM)
-  137 g - 4.83 oz (TI)



## DAMASCO | DAMASCUS

### VA5980FCM

Manico in fibra di carbonio Dark Matter nero by Fatcarbon® 3D Black Dark Matter by Fatcarbon® carbon fiber handle



## STONE WASHED

### V5982CB

Manico in Micarta nera  
Black Micarta handle



### V5982CG

Manico in Micarta verde  
Green Micarta handle



### V5982GB3D

Manico in G10 nero 3D  
3D black Micarta handle



## DARK STONE WASHED

### V5984TI

Manico in titanio dark stone washed  
Dark stone washed titanium handle



### V5984TI3D

Manico in titanio dark stone washed 3D  
3D dark stone washed titanium handle



## SATINATA | SATIN

### V5980FCM

Manico in fibra di carbonio Dark Matter nero by Fatcarbon®  
Black Dark Matter by Fatcarbon® carbon fiber handle



### V5985ZI

Manico in ziricote  
Ziricote wood handle



### V5985BC

Manico in bocote  
Bocote wood handle



# TWIN

designed by Fabrizio Silvestrelli



## COLTELLO CHIUDIBILE FOLDING KNIFE

### SLIP JOINT

-  M390
-  59-61
-  AISI 420 sabbaiato  
Sandblasted AISI 420
-  AISI 420 sabbaiato  
Sandblasted AISI 420
-  AISI 303 sabbaiato  
Sandblasted AISI 303



-  7,7 cm - 3 1/32"
-  17,6 cm - 7"
-  3 mm - 0.12"
-  88 g - 3.10 oz



Fodero in cuoio marrone  
Brown leather sheath

## COLTELLO CHIUDIBILE FOLDING KNIFE

### ACTION-STOPPER-SYSTEM

-  N690Co
-  57-59
-  AISI 420 sabbaiato  
Sandblasted AISI 420
-  Titanio sabbaiato  
Sandblasted titanium
-  AISI 303 sabbaiato  
Sandblasted AISI 303
-  AISI 420 sabbaiato  
Sandblasted AISI 420

-  7,3 cm - 2 7/8"
-  18,2 cm - 7 3/16"
-  3 mm - 0.12"
-  57 g - 3.06 oz



# Dan1

designed by Tommaso Rumici

## SATINATA | SATIN

### V6002FCG

Manico in titanio sabbaiato con guancetta in fibra di carbonio Dark Matter oro by Fatcarbon®  
Sandblasted titanium handle with gold Dark Matter by Fatcarbon® carbon fiber scale



### V6002GR

Manico in titanio sabbaiato con guancetta in G10 borgogna  
Sandblasted titanium handle with burgundy G10 scale



### V6002GI

Manico in titanio sabbaiato con guancetta in G10 avorio  
Sandblasted titanium handle with ivory G10 scale



### V6002CN

Manico in titanio sabbaiato con guancetta in Micarta naturale  
Sandblasted titanium handle with natural Micarta scale



## SATINATA | SATIN

### V5928ZI

Manico in ziricote  
Ziricote wood handle



### V5928UL

Manico in ulivo  
Olive wood handle



# OR502

designed by Jens Anso



## COLTELLO CHIUDIBILE FOLDING KNIFE

### LINER LOCK

- LO-QPM 20-4
- HRC 57-59
- AISI 420 sabbiato  
Sandblasted AISI 420
- Titanio sabbiato o titanio anodizzato blu  
Sandblasted titanium or blue anodized titanium
- AISI 303 sabbiato  
Sandblasted AISI 303
- Sagomata in titanio sabbiato o sagomata in titanio anodizzato blu  
Sandblasted shaped titanium or blue anodized shaped titanium

8,7 cm - 3 3/8"

20,8 cm - 8 1/8"

4 mm - 0.16"

125 g - 4.40 oz (TI)

92 g - 3.20 oz (GB-GO-GG)

85 g - 2.99 oz (FC)



CLIP  
Sagomata in titanio anodizzato blu  
Blue anodized shaped titanium

CLIP  
Sagomata in titanio sabbiato  
Sandblasted shaped titanium

V5996TI  
V5996TI3D



V5998FC  
V5998CG  
V5997TI  
V5997TI3D



## SATINATA | SATIN

V5996TI

Manico in titanio stone washed  
Stone washed titanium handle



V5996TI3D

Manico in titanio sabbiato con lavorazione 3D  
With sandblasted titanium handle with 3D machining



## STONE WASHED

V5998FC

Manico in fibra di carbonio  
Carbon fiber handle



## STONE WASHED

V5998CG

Manico in Mivarda verde  
Green Micarta handle



## DARK STONE WASHED

V5997TI

Manico in titanio dark stone washed  
Dark stone washed titanium handle



V5997TI3D

Manico in titanio dark stone washed lavorazione 3D  
Dark stone washed titanium handle with 3D machining



# Hug

designed by Sacha Thiel



## COLTELLO CHIUDIBILE FOLDING KNIFE

### SLIP JOINT

- M390
- 59-61
- Titanio satinato  
Satin titanium
- AISI 420 satinato  
Satin AISI 420
- AISI 303 sabbaiato  
Sandblasted AISI 303

- 7,1 cm - 3"
- 18,4 cm - 7 1/4"
- 3 mm - 0.12"
- 75 g - 2.64 oz



Fodero in cuoio marrone  
Brown leather sheath

## COLTELLO CHIUDIBILE FOLDING KNIFE

### SLIP JOINT

- M390
- 59-61
- Titanio sabbaiato  
Sandblasted titanium
- AISI 420 lucido  
Polished AISI 420
- AISI 303 sabbaiato  
Sandblasted AISI 303

- 7,6 cm - 3"
- 18,5 cm - 7 1/4"
- 3 mm - 0.12"
- 70-75 g - 2.47-2.65 oz



Fodero in cuoio marrone  
Brown leather sheath

# key

designed by Jesper Voxnæs



## SATINATA | SATIN

### V5990DBRS

Manico in bronzo dark stone washed con disegno stelle  
Stars texture dark stone washed bronze handle



### V5990BRS

Manico in bronzo sabbaiato con disegno stelle  
Stars texture sandblasted bronzehandle



### V5992FCR

Manico in titanio sabbaiato con guancetta in fibra di carbonio Dark Matter rosso by Fatcarbon®  
Sandblasted titanium handle with red Dark Matter by Fatcarbon® carbon fiber scale



### V5992CG

Manico in titanio sabbaiato con guancetta in Micarta verde  
Sandblasted titanium handle with green Micarta scale



## SATINATA | SATIN

### V5976FC

Manico in fibra di carbonio  
Carbon fiber handle



### V5976CN

Manico in Micarta naturale  
Natural Micarta handle



### V5978FCB

Manico in titanio sabbaiato con guancetta in fibra di carbonio bronzo  
Sandblasted titanium handle with bronze carbon fiber scale



### V5978CV

Manico in titanio sabbaiato con guancetta in Micarta verde  
Sandblasted titanium handle with green Micarta scale















# ODINO

designed by Jesper Voxnæs



## COLTELLO CHIUDIBILE FOLDING KNIFE

### FRAME LOCK

-  Damasco Rose by Damasteel®  
Rose damascus by Damasteel®  
N690
  -  58-60
  -  N690Co
  -  57-59
  -  Titanio dark stone washed  
Dark stone washed titanium
  -  Titanio dark stone washed o titanio  
anodizzato blu  
Dark stone washed titanium or blue  
anodized titanium
  -  AISI 303 sabbiato  
Sanblasted AISI 303
  -  Sagomata in titanio stone washed  
Stone washed shaped titanium
  -  Sagomata in AISI 420 sabbiato  
Sanblasted shaped AISI 420
- 
-  7,5 cm - 3"
  -  18,5 cm - 7 1/4"
  -  4 mm - 0.16"
  -  160 g - 5.6 oz

## COLTELLO CHIUDIBILE FOLDING KNIFE

### LINER LOCK

-  M390
  -  59-61
  -  Titanio sabbiato  
Sandblasted titanium
  -  Titanio sabbiato  
Sanblasted titanium
  -  Titanio cesellato  
Chiseled finish titanium
  -  AISI 303 sabbiato  
Sandblasted AISI 303
- V5972FC  
V5972CV

V5974BC
- 
-  7,6 cm - 3"
  -  17,8 cm - 7"
  -  4 mm - 0.16"
  -  115 g - 4.05 oz

# novis

designed by Fabrizio Silvestrelli



## DAMASCO | DAMASCUS

### VA5918BSW

Manico in titanio dark stone washed con  
texture anodizzata blu  
Dark stone washed titanium handle with  
blue anodized texture



## STONE WASHED

### V5918GB

Manico in G10 nero  
Black G10 handle



### V5918GG

Manico in G10 verde  
Green G10 handle



## PVD NERO | BLACK PVD

### V5920GB

Manico in G10 nero  
Black G10 handle



## SATINATA | SATIN

### V5974BC

Manico in titanio sabbiato e cesellato con  
guancetta in bocote  
Sandblasted and chiseled finish titanium  
handle with bocote wood scale



### V5972FC

Manico in fibra di carbonio  
Carbon fiber handle



### V5972CV

Manico in Micarta verde  
Green Micarta handle



Espositore in legno e plexiglass  
Wooden and plexiglass display

# Lille

designed by Jesper Voxnæs



## COLTELLO CHIUDIBILE FOLDING KNIFE

### FRAME LOCK

Damasco Damasteel® Bjorkmans Twist  
Damasteel® Bjorkmans Twist damascus

58-60

Titanio sabbaiato o titanio anodizzato  
blu o bronzo  
Sandblasted titanium or blue or  
bronze anodized titanium

Titanio sabbaiato o titanio anodizzato  
blu o bronzo  
Sandblasted titanium or blue or  
bronze anodized titanium

AISI 303 sabbaiato  
Sandblasted AISI 303

Sagomata in titanio sabbaiato o  
titanio anodizzato blu o bronzo  
Sandblasted shaped titanium or  
blue or bronze anodized shaped

6,3 cm - 2 1/2"

15,7 cm - 6 1/4"

3 mm - 0.12"

83-90 g - 2.92-3.17 oz

## COLTELLO CHIUDIBILE FOLDING KNIFE

### FRAME LOCK

M390

59-61

Titanio sabbaiato o titanio anodizzato  
blu o bronzo o titanio dark stone  
washed  
Sandblasted titanium or blue or  
bronze anodized titanium or dark  
stone washed titanium

Titanio sabbaiato o titanio anodizzato  
blu o bronzo o titanio dark stone  
washed  
Sandblasted titanium or blue or  
bronze anodized titanium or dark  
stone washed titanium

AISI 303 sabbaiato  
Sandblasted AISI 303

Sagomata in titanio sabbaiato o  
sagomata in titanio anodizzato blu  
o bronzo o sagomata in titanio dark  
stone washed  
Sandblasted shaped titanium or  
blue or bronze anodized shaped  
titanium or dark stone washed  
shaped titanium

6,3 cm - 2 1/2"

15,7 cm - 6 1/4"

3 mm - 0.12"

CLIP  
Sagomata in titanio sabbaiato  
Sanblasted shaped titanium

VA5964BL

V5962TITI



CLIP  
Sagomata in titanio anodizzato blu  
Blue anodized shaped titanium

V5962TIBL



CLIP  
Sagomata in titanio anodizzato bronzo  
Bronze anodized shaped titanium

VA5964TIBR

V5962TIBR



CLIP  
Sagomata in titanio dark stone washed  
Dark stone washed shaped titanium

V5963TITI



## DAMASCO | DAMASCUS

### VA5964BL

Manico in titanio anodizzato blu con guancetta  
in damasco Damasteel® Bjorkmans Twist  
Blue anodized titanium handle with Damasteel®  
Bjorkmans Twist damascus scale



### VA5964TIBR

Manico in titanio sabbaiato con guancetta in  
titanio anodizzato bronzo  
Sandblasted titanium handle with bronze  
anodized titanium scale



Scatola premium in legno  
(La versione VA5964BL viene  
accompagnata anche da un  
bijoux in damasco)

Premium wooden box  
(VA5964BL version also comes  
with a damask bijoux)



## SATINATA | SATIN

### V5962TITI

Manico in titanio sabbaiato con guancetta in  
titanio sabbaiato  
Sandblasted titanium handle with sandblasted  
titanium scale



### V5962TIBL

Manico in titanio sabbaiato con guancetta in  
titanio anodizzato blu  
Sandblasted titanium handle with blue anodized  
titanium scale



### V5962TIBR

Manico in titanio sabbaiato con guancetta in  
titanio anodizzato bronzo  
Sandblasted titanium handle with bronze  
anodized titanium scale



## DARK STONE WASHED

### V5963TITI

Manico in titanio dark stone washed con  
guancetta in titanio sabbaiato  
Dark stone washed titanium handle with  
sandblasted titanium scale



# magà





designed by Boris Manasherov



## COLTELLO CHIUDIBILE FOLDING KNIFE





### LINER LOCK





-  N690Co
-  HRC 58-60
-  AISI 420 sabbato  
Sandblasted AISI 420
-  AISI 303 sabbato  
Sandblasted AISI 303
-  AISI 303 sabbato  
Sandblasted ISI 303
-  AISI 420 sabbato  
Sandblasted AISI 420

-  9,5 cm - 3 3/4"
-  21 cm - 8 1/2"
-  3 mm - 0.12"
-  145-160 g - 5.11-5.64 oz

## COLTELLO CHIUDIBILE FOLDING KNIFE

### ADVANCED BACK LOCK

-  Elmax
-  HRC 59-61
-  AISI 420 sabbato  
Sandblasted AISI 420
-  AISI 420 sabbato  
Sandblasted AISI 420
-  AISI 303 sabbato  
Sandblasted AISI 303
-  AISI 420 sabbato  
Sandblasted AISI 420

-  10,8 cm - 4 1/2"
-  25,3 cm - 10"
-  4,2 mm - 0.16"
-  245-280 g - 6.64-9.88 oz

# RHINO 1

designed by Fabrizio Silvestrelli



## SATINATA | SATIN

### V5910FC

Manico in fibra di carbonio  
Carbon fiber handle



### V5910CB

Manico in santos  
Santos wood handle



## STONE WASHED

### V5912FC

Manico in fibra di carbonio  
Carbon fiber handle



### V5912CG

Manico in Micarta verde  
Green Micarta handle



### V5912GO

Manico in C10 arancione  
Orange C10 handle



## SATINATA | SATIN

### V5901CB

Manico in pau santo  
Pau santo wood handle



## STONE WASHED

### V5903FC

Manico in fibra di carbonio  
Carbon fiber handle



## DARK STONE WASHED

### V5905CV

Manico in Micarta verde  
Green Micarta handle







designed by Fabrizio Silvestrelli



#### COLTELLO CHIUDIBILE FOLDING KNIFE

##### EVOLUTION LOCK BACK

-  N690Co
-  58-60
-  AISI 303 sabbaiato  
Sandblasted AISI 303
-  AISI 420 satinato  
Satin AISI 420
-  AISI 303 sabbaiato  
Sandblasted AISI 303
-  AISI 420 sabbaiato  
Sandblasted AISI 420

-  75 cm - 3"
-  18,5 cm - 7 1/4"
-  3,7 mm - 0.15"
-  105-110 g - 3.7-3.88 oz







Fodero in cuoio nero  
Black leather sheath

#### COLTELLO CHIUDIBILE FOLDING KNIFE

##### LINER LOCK

-  N690Co
-  58-60
-  AISI 420 sabbaiato  
Sandblasted AISI 420
-  AISI 303 sabbaiato  
Sandblasted AISI 303
-  AISI 303 sabbaiato  
Sandblasted ISI 303
-  AISI 420 sabbaiato  
Sandblasted AISI 420

-  70 cm - 2 3/4"
-  16,7 cm - 6 5/8"
-  3 mm - 0.12"
-  78-80gr - 2.65-2.82 oz



Fodero in cuoio nero  
Black leather sheath



#### LUCIDA | POLISHED

##### V5510MO

Manico in titanio martellato e guancette in corno di montone / corno di bue  
Hammered titanium handle and ram's horn / ox horn bolster



##### V5510CB

Manico in titanio martellato e guancette in santos  
Hammered titanium handle and santos wood bolster



#### LUCIDA | POLISHED

##### V5510BC

Manico in titanio martellato e guancette in bocote  
Hammered titanium handle and bocote wood bolster



##### V5510UL

Manico in titanio martellato e guancette in ulivo  
Hammered titanium handle and olive wood bolster



##### V5500UL

Manico in ulivo  
Olive wood handle



#### SATINATA | SATIN

##### V5411CB

Manico in titanio martellato e guancette in santos  
Hammered titanium handle and santos wood bolster



##### V5411BC

Manico in titanio martellato e guancette in bocote  
Hammered titanium handle and bocote wood bolster



##### V5411UL

Manico in titanio martellato e guancette in ulivo  
Hammered titanium handle and olive wood bolster



#### SATINATA | SATIN

##### V5400CB

Manico in santos  
Santos wood handle



##### V5400BC

Manico in bocote  
Bocote wood handle



# Boletus





designed by Fabrizio Silvestrelli



## COLTELLO CHIUDIBILE FOLDING KNIFE

### ACTION-STOPPER-SYSTEM

-  NITRO B
-  55-57
-  AISI 420 lucido  
Polished AISI 420
-  AISI 303 lucido  
Polished AISI 303
-  AISI 303 sabbbiato  
Sandblasted AISI 303

-  7 cm - 2 3/4"
-  18 cm - 7 1/8"
-  3 mm - 0.12"
-  100-104 g - 3.53-3.67 oz

Fodero in cuoio nero  
Black leather sheath

## COLTELLO CHIUDIBILE FOLDING KNIFE

### LINER LOCK

-  N690
-  58-60
-  AISI 303 satinato  
Satin AISI 303
-  AISI 303 satinato  
Satin AISI 303
-  AISI 303 sabbbiato  
Sandblasted AISI 303

-  4,9 cm - 1 15/16"
-  12,3 cm - 4 7/8"
-  3 mm - 0.12"
-  60-62 g - 2.12-2.19 oz

Fodero in cuoio nero  
Black leather sheath

# Drop

designed by Fabrizio Silvestrelli



## SATINATA | SATIN

### V5600PC

Manico in corno di bue  
Ox horn handle



### V5600CB

Manico in santos  
Santos wood handle



Spazzola retraibile per la rimozione  
di residui di terra e fogliame

Retractable brush for removing soil  
and foliage debris



## SATINATA | SATIN

### V5700MO

Manico in corno di bue  
Ox horn handle



### V5700UL

Manico in ulivo  
Olive wood handle



## SERIE PIUMA



Fodero in cuoio nero  
Black leather sheath

COLTELLO CHIUDIBILE  
FOLDING KNIFE

DROP - TIMELESS: LINER LOCK  
QUALITY: EVOLUTION BACK LOCK

-  N690
-  HRC 58-60
-  AISI 420 satinato  
Satin AISI 420
-  AISI 420 lucido  
Polished AISI 420
-  AISI 303 sabbato  
Sandblasted AISI 303

## DROP

-  4,9 cm - 1 15/16"  3 mm - 0.12"
-  12,3 cm - 4 7/8"  60-62 g - 2.12-2.19 oz

## QUALITY

-  7,5 cm - 3"  3 mm - 0.12"
-  18,5 cm - 7 1/4"  105 g - 3.70 oz

## TIMELESS

-  7 cm - 2 3/4"  3 mm - 0.12"
-  16,7 cm - 6 5/8"  82 g - 2.89 oz



## DROP

## SATINATA | SATIN

## V5700IN-FO

Manico in resina con inserto piuma di fagiano  
Resin with pheasant feather insert handle



## V5700IN-BC

Manico in resina con inserto piuma di beccaccia  
Resin with woodcock feather insert handle



## V5700IN-GH

Manico in resina con inserto piuma di ghiandaia  
Resin with jay feather insert handle



## V5700IN-PN

Manico in resina con inserto piuma di pernice  
Resin with partridge feather insert handle



## V5700IN-AL

Manico in resina con inserto piuma di alzavola  
Resin with jay feather insert handle



## QUALITY

## SATINATA | SATIN

## V5500IN-BC

Manico in resina con inserto piuma di beccaccia  
Resin with woodcock feather insert handle



## V5500IN-GH

Manico in resina con inserto piuma di ghiandaia  
Resin with jay feather insert handle



## TIMELESS

## SATINATA | SATIN

## V5400IN-BC

Manico in resina con inserto piuma di beccaccia  
Resin with woodcock feather insert handle



## V5400IN-GH

Manico in resina con inserto piuma di ghiandaia  
Resin with jay feather insert handle







# REGIONALI



## COLTELLO CHIUDIBILE FOLDING KNIFE

### ACTION-STOPPER-SYSTEM

-  AISI 440 A
-  55-57
-  AISI 420 lucido  
Polished AISI 420
-  AISI 303 lucido  
Polished AISI 303
-  AISI 303 lucido  
Polished AISI 303

### VERNANTE

-  8,5 cm - 1 15/16"  3 mm - 0.12"
-  20,2 cm - 7 7/8"  98 g - 3.46 oz





### RASOLINO

-  8,5 cm - 3 3/4"  3 mm - 0.12"
-  20,2 cm - 7 7/8"  90 g - 3.17 oz

### SENESE

-  8,5 cm - 1 15/16"  3 mm - 0.12"
-  12,3 cm - 4 7/8"  60-62 g - 2.12-2.19 oz

### BERGAMASCO





-  8,5 cm - 3 3/4"  3 mm - 0.12"
-  9,8 cm - 3.46"  98 g - 3.46 oz

## COLTELLO CHIUDIBILE FOLDING KNIFE





### ACTION-STOPPER-SYSTEM

-  AISI 440 A
-  55-57
-  AISI 420 lucido  
Polished AISI 420
-  AISI 303 lucido  
Polished AISI 303
-  AISI 303 lucido  
Polished AISI 303

### MAREMMANO

-  8,5 cm - 3 3/4"  3 mm - 0.12"
-  20,2 cm - 7 7/8"  80 g - 2.82 oz

### GOBBO

-  8,5 cm - 3 3/4"  3 mm - 0.12"
-  20,2 cm - 7 7/8"  85 g - 3 oz



## VERNANTE

SATINATA | SATIN

V5748CO

Manico in punta di corno di bue  
Ox horn tip handle



## SENESE

SATINATA | SATIN

V5740PC

Manico in punta di corno di bue  
Ox horn tip handle



V5740UL

Manico in ulivo  
Olive wood handle



## MAREMMANO

SATINATA | SATIN

V5742PC

Manico in punta di corno di bue  
Ox horn tip handle



V5742NO

Manico in noce  
Walnut wood handle



V5742CI

Manico in ciliegio  
Cherry wood handle



## GOBBO

SATINATA | SATIN

V5746PC

Manico in punta di corno di bue  
Ox horn tip handle



V5746CB

Manico in santos  
Santos wood handle



## RASOLINO

SATINATA | SATIN

V5750PC

Manico in punta di corno di bue  
Ox horn tip handle



V5750UL

Manico in ulivo  
Olive wood handle



## BERGAMASCO

SATINATA | SATIN

V5744PC

Manico in punta di corno di bue  
Ox horn tip handle



V5744CB

Manico in santos  
Santos wood handle





## **LAMA FISSA FIXED BLADE**

I coltelli a lama fissa di Viper uniscono materiali d'eccellenza e prestazioni elevate.

Le lame, realizzate con acciai avanzati ad alta resistenza e durezza, garantiscono un'affilatura duratura e un taglio preciso. Le impugnature, in fibra di carbonio, G10 o legni stabilizzati, offrono ergonomia e presa sicura anche in condizioni difficili. Perfetti per l'outdoor e l'uso intensivo, questi coltelli rappresentano il connubio ideale tra innovazione, robustezza e qualità artigianale.

Viper fixed-blade knives combine premium materials with high performance. The blades, made from advanced high-strength steels, ensure long-lasting sharpness and precise cutting. Handles crafted from carbon fiber, G10, or stabilized woods provide excellent ergonomics and a secure grip, even in challenging conditions. Perfect for outdoor and heavy-duty use, these knives embody the ideal blend of innovation, durability, and fine craftsmanship.

# TRAIL

designed by Jens Anso



## COLTELLO FISSO FIXED KNIFE

-  N690
-  HRC 58-60
-  AISI 303 sabbiato  
Sandblasted AISI 303

 17,6 cm - 6.9"

 28,2 cm - 11.1"

 4 mm - 0.16"

 178 g - 6.27 oz



Fodero in cuoio marrone  
Brown leather sheath



## SATINATA | SATIN

### VT4068FC

Manico in carbon fiber  
Carbon fiber handle



### VT4068BC

Manico in bocote  
Bocote wood handle



### VT4068UL

Manico in ulivo  
Olive wood handle



## STONE WASHED

### VT4066GG

Manico in Suretouch™ nero  
Black Suretouch™ handle



### VT4066CG

Manico in Micarta verde  
Green Micarta handle



### VT4066CN



Manico in Micarta naturale  
Natural Micarta handle







# RANGER

designed by Jens Anso

## COLTELLO FISSO FIXED KNIFE

-  N690
-  58-60
-  AISI 303 sabbbiato  
Sandblasted AISI 303

-  11,7 cm - 4 5/8"
-  22,6 cm - 8 15/16"
-  4 mm - 0.16"
-  150 g - 5.29 oz



## COLTELLO FISSO FIXED KNIFE

-  N690
-  58-60
-  AISI 303 sabbbiato  
Sandblasted AISI 303

-  9,7 cm - 3 13/16"
-  20,7 cm - 8 1/2"
-  4 mm - 0.16"
-  146 g - 5.16 oz



# NORDLYS

designed by Jens Anso

## SATINATA | SATIN

**VT4056BC** Manico in bocote  
Bocote wood handle



## STONE WASHED

**VT4054GG** Manico in Suretouch™ nero  
Black Suretouch™ handle



**VT4054CG** Manico in Micarta verde  
Green Micarta handle



## SATINATA | SATIN

**VT4046BC** Manico in bocote  
Bocote wood handle



**VT4046UL** Manico in ulivo  
Olive wood handle



## STONE WASHED

**VT4044GG** Manico in Suretouch™ nero  
Black Suretouch™ handle



**VT4044CG** Manico in Micarta verde  
Green Micarta handle



# MIRROR 1

designed by Igor Bortolussi

## COLTELLO FISSO FIXED KNIFE

- M390
- HRC 59-61
- AISI 303 sabbiato  
Sandblasted AISI 303

- 7,9 cm - 3 1/8"
- 4 mm - 0.16"
- 17,6 cm - 7"
- 95 g - 3.35 oz



Fodero in cuoio nero  
Black leather sheath

## COLTELLO FISSO FIXED KNIFE

- M390
- HRC 59-61
- AISI 303 sabbiato  
Sandblasted AISI 303

- 6,8 cm - 2 3/8"
- 4 mm - 0.16"
- 17,6 cm - 7"
- 95 g - 3.35 oz



Fodero in cuoio nero  
Black leather sheath

# MIRROR 2

designed by Igor Bortolussi



## SATINATA | SATIN

### VT4058BC

Manico in bocote  
Bocote wood handle



## STONE WASHED

### VT4060CG

Manico in Micarta verde  
Green Micarta handle



### VT4060CD

Manico in Micarta blu denim  
Blue denim Micarta handle



## SATINATA | SATIN

### VT4062BC

Manico in bocote  
Bocote wood handle



## STONE WASHED

### VT4064CG

Manico in Micarta verde  
Green Micarta handle



### VT4064CD

Manico in Micarta blu denim  
Blue denim Micarta handle



Handy

designed by Fabrizio Silvestrelli

COLTELLO FISSO  
FIXED KNIFE
 Magnacut

 62-64

 AISI 303 sabbiato o AISI 303 PVD  
nero  
Sandblasted AISI 303 or black PVD  
AISI 303

 8,4 cm - 3 1/8"

 18 cm - 7"

 4 mm - 0.16"

 115 g - 4.05 oz

Fodero in cuoio marrone  
per le varianti in legno  
Brown leather sheath for  
wooden variants



Fodero in Kydex®  
Kydex® sheath



## SATINATA | SATIN

VT4038FCM

Manico in fibra di carbonio Dark Matter nero by  
Fatcarbon®  
Black Dark Matter by Fatcarbon® carbon fiber  
handle



VT4038BC

Manico in bocote  
Bocote wood handle



VT4038NO

Manico in noce  
Walnut wood handle



## STONE WASHED

VT4040CG

Manico in Micarta verde  
Green Micarta handle



VT4040GG

Manico in Suretouch™ nero  
Black Suretouch™ handle

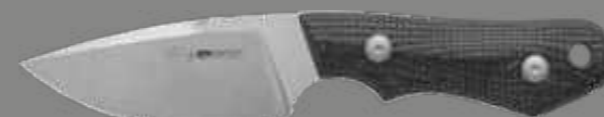

## DARK STONE WASHED

VT4042UT

Manico in ULTEM™  
ULTEM™ handle



VT4042CG

Manico in Micarta verde  
Green Micarta handle



VT4042GG

Manico in Suretouch™ nero  
Black Suretouch™ handle



# Handy 2

designed by Fabrizio Silvestrelli



## COLTELLO FISSO FIXED KNIFE

- M390
- 59-61
- AISI 303 sabbiato  
Sandblasted AISI 303

- 8,4 cm - 3 1/8"
- 18 cm - 7"
- 4 mm - 0.16"
- 115 g - 4.05 oz



Fodero in cuoio marrone  
per le varianti in legno  
Brown leather sheath for  
wooden variants



Fodero in Kydex®  
Kydex® sheath



## SATINATA | SATIN

**VT4048FCM** Manico in fibra di carbonio Dark Matter nero by Fatcarbon®  
Black Dark Matter by Fatcarbon® carbon fiber handle



**VT4048BC** Manico in bocote  
Bocote wood handle



**VT4048NO** Manico in noce  
Walnut wood handle



## STONE WASHED

**VT4050CN** Manico in Micarta naturale  
Natural Micarta handle



**VT4050CG** Manico in Micarta verde  
Green Micarta handle



**VT4050GG** Manico in Suretouch™ nero  
Black Suretouch™ handle



# BASIC

designed by Tommaso Rumici



Lama DROP POINT  
DROP POINT blade



Lama SPARE POINT  
SPARE POINT blade

## COLTELLO FISSO FIXED KNIFE

 Magnacut

 62-64

### BASIC 1

 9 cm - 3 1/2"

 20,3 cm - 8"

 4 mm - 0.16"

 210 g - 7.4 oz

### BASIC 3

 9,3 cm - 3 3/8"

 20,4 cm - 8 1/8"

 4 mm - 0.16"

 210 g - 7.4 oz



Fodero in Kydex®  
con TEK-LOK  
Kydex® with  
TEK-LOK sheath



## BASIC 1

SATINATA | SATIN

VT4026FCM

Manico in fibra di carbonio Dark Matter  
nero by Fatcarbon®  
Black Dark Matter by Fatcarbon® carbon  
fiber handle



VT4026CG

Manico in Micarta verde  
Green Micarta handle



## BASIC 3

SATINATA | SATIN

VT4034FCM

Manico in fibra di carbonio Dark Matter  
nero by Fatcarbon®  
Black Dark Matter by Fatcarbon® carbon  
fiber handle



VT4034CG

Manico in Micarta verde  
Green Micarta handle



# BERUS

designed by Tommaso Rumici

Lama DROP POINT  
DROP POINT blade

Lama SHEEPFOOT  
SHEEPFOOT blade



COLTELLO FISSO  
FIXED KNIFE

M390

HRC 60-61

BERUS 1

6,7 cm - 2 3/8" 4 mm - 0.16"

15,4 cm - 6 1/16" 95 g - 3.35 oz

BERUS 2

6,2 cm - 2 1/2" 4 mm - 0.16"

15,4 cm - 6 1/16" 95 g - 3.35 oz



Fodero in Kydex®  
con ULTICLIP  
Kydex® with  
ULTICLIP sheath



## BERUS 1

SATINATA | SATIN

VT4012FC

Manico in fibra di carbonio  
Carbon fiber handle



PVD NERO | BLACK PVD

VT4012DGJ

Manico in G10 giada  
Jade G10 handle



STONE WASHED

VT4012CB

Manico in Micarta nera  
Black Micarta handle



VT4012DGR

Manico in G10 rosso  
Red G10 handle



## BERUS 2

SATINATA | SATIN

VT4014FCM

Manico in fibra di carbonio marmorizzata  
Marbled carbon fiber handle



PVD NERO | BLACK PVD

VT4014DCG

Manico in Micarta verde  
Green Micarta handle



VT4014FC

Manico in fibra di carbonio  
Carbon fiber handle



STONE WASHED

VT4014CG

Manico in Micarta verde  
Green Micarta handle



# Gianghi

designed by Fabrizio Silvestrelli

## COLTELLO FISSO FIXED KNIFE

-  N690Co
-  HRC 58-60
-  AISI 303 sabbato  
Sandblasted AISI 303

-  11,5 cm - 4 1/2"
-  24,8 cm - 9 3/4"
-  5 mm - 0.20"
-  240 g - 8.46 oz

Fodero in cuoio marrone  
Brown leather sheath



## COLTELLO FISSO FIXED KNIFE

-  D2
-  HRC 59-60
-  AISI 303 sabbato  
Sandblasted AISI 303

### DAVID

-  10,5 cm - 4 1/8"
-  22,7 cm - 8"
-  5,8 mm - 0.23"
-  260 g - 9.17 oz

### GOLIA

-  12,5 cm - 5"
-  25,2 cm - 10"
-  5,8 mm - 0.23"
-  280 g - 9.88 oz

Fodero in Cordura® con  
anima in gomma balistica  
reversibile per ambidestri  
e sistema MOLLE  
Cordura® sheath with  
reversible ballistic rubber  
core for ambidextrous  
and MOLLE system



# DAVID GOLIA

designed by Igor Bortolussi



## SATINATA | SATIN

### V4880BC

Manico in bocote  
Bocote wood handle



### V4880UL

Manico in ulivo  
Olive wood handle



## DAVID

### DARK STONE WASHED

#### VT4002ECB

Manico in Micarta nero  
Black Micarta handle



## GOLIA

### DARK STONE WASHED

#### VT4003ECB

Manico in Micarta nero  
Black Micarta handle







# POINTER

designed by Tommaso Rumici



## COLTELLO FISSO FIXED KNIFE

-  N690Co
-  58-60
-  AISI 303 sabbiato  
Sandblasted AISI 303

 10,5 cm - 4 1/8"

 22,7 cm - 8"

 3,8 mm - 0.15"

 165 g - 5.82 oz



Fodero in cuoio marrone  
Brown leather sheath



## STONE WASHED

V4870UL

Manico in ulivo  
Olive wood handle





**BlackFOX<sup>®</sup>**

## **BLACK FOX**

Black Fox è una linea di prodotti delle Coltellerie FOX dedicata a coloro che desiderano un prodotto di qualità ad un prezzo accessibile. La linea dei coltelli Black Fox presenta un assortimento di coltelli chiudibili, con diversi meccanismi di apertura e di lama fissa studiati attentamente da noti designers assieme al Fox Knives team per soddisfare le esigenze di chi pratica attività all'aperto come il campeggio, la pesca, la caccia e per coloro che amano gli EDC dalle linee moderne. Il marchio Black Fox è garantito grazie all'esperienza delle Coltellerie FOX che produce coltelli dal 1977.

Black Fox is a product line from FOX Knives dedicated to those who want a quality product at an affordable price. The Black Fox line features an assortment of folding knives, with different opening mechanisms, and fixed blade knives carefully designed by well-known designers together with the Fox Knives team to meet the needs of those who enjoy outdoor activities such as camping, fishing, hunting, and for those who like EDCs with modern lines. The Black Fox brand is guaranteed thanks to the experience of FOX Knives, which has been manufacturing knives since 1977.

# BF-770 ATROS



## BF-770 BB BUTTON LOCK

NEW ITEM

 8,5 cm - 3.35"
  3 mm - 0.12"
  20 cm - 7.87"
  140 g - 4.93 oz

**LAMA | BLADE**  
VG10 PTFE nero  
Black PTFE VG10  
HRC 59-61

**MANICO | HANDLE**  
G10 nero  
Black G10

**BUTTON LOCK**  
Acciaio inox lucido  
Polished stainless steel

**DISTANZIALE | SPACER**  
Acciaio inox lucido  
Polished stainless steel

**CLIP**  
Sagomata in acciaio inox PTFE nero  
Black PTFE shaped stainless steel

**VITI | SCREWS**  
Acciaio inox lucido  
Polished stainless steel



## BF-770 BL BUTTON LOCK

NEW ITEM

**LAMA | BLADE**  
VG10 stone washed  
Stone washed VG10  
HRC 59-61



**MANICO | HANDLE**  
Alluminio anodizzato blu  
Blue anodized aluminium

**BUTTON LOCK**  
Acciaio inox lucido  
Polished stainless steel

**DISTANZIALE | SPACER**  
Acciaio inox lucido  
Polished stainless steel

**CLIP**  
Sagomata in acciaio  
inox lucido  
Polished shaped  
stainless steel

**VITI | SCREWS**  
Acciaio inox lucido  
Polished stainless steel

 8,5 cm - 3.35"
  3 mm - 0.12"

 20 cm - 7.87"
  152 g - 5.36"



## BF-770 WD BUTTON LOCK

NEW ITEM

**LAMA | BLADE**  
VG10 stone washed  
Stone washed VG10  
HRC 59-61

**MANICO | HANDLE**  
Santalò  
Sandal wood

**BUTTON LOCK**  
Acciaio inox lucido  
Polished stainless steel

**DISTANZIALE | SPACER**  
Acciaio inox lucido  
Polished stainless steel

**CLIP**  
Sagomata in acciaio  
inox lucido  
Polished shaped  
stainless steel

**VITI | SCREWS**  
Acciaio inox lucido  
Polished stainless steel

 8,5 cm - 3.35"
  3 mm - 0.12"

 20 cm - 7.87"
  122 g - 4.30"

# BF-771 DRIPPER



## BF-771 MB LINER LOCK

NEW ITEM



**LAMA | BLADE**  
VG10 stone washed  
Stone washed VG10  
HRC 59-61

**DISTANZIALE | SPACER**  
Acciaio inox lucido  
Polished stainless steel

**MANICO | HANDLE**  
Micarta nera  
Black Micarta

**CLIP**  
Sagomata in acciaio inox lucido  
Polished shaped stainless steel

**LINER LOCK**  
Acciaio inox lucido  
Polished stainless steel

**VITI | SCREWS**  
Acciaio inox lucido  
Polished stainless steel



## BF-771 MOD LINER LOCK

NEW ITEM



**LAMA | BLADE**  
VG10 stone washed  
Stone washed VG10  
HRC 59-61

**DISTANZIALE | SPACER**  
Acciaio inox lucido  
Polished stainless steel

**MANICO | HANDLE**  
Micarta verde OD  
OD green Micarta

**CLIP**  
Sagomata in acciaio inox lucido  
Polished shaped stainless steel

**LINER LOCK**  
Acciaio inox lucido  
Polished stainless steel

**VITI | SCREWS**  
Acciaio inox lucido  
Polished stainless steel



# BF-781 PARADIGMA



## BF-781 ZW LINER LOCK

NEW ITEM



**LAMA | BLADE**  
D2 satinato  
Satin D2  
HRC 59-61

**DISTANZIALE | SPACER**  
G10 nero  
Black G10

**MANICO | HANDLE**  
Zebrano  
Zebra wood

**CLIP**  
Sagomata in acciaio inox lucido  
Polished shaped stainless steel

**LINER LOCK**  
Acciaio inox lucido  
Polished stainless steel

**VITI | SCREWS**  
Acciaio inox lucido  
Polished stainless steel



## BF-781 G10 LINER LOCK

NEW ITEM



**LAMA | BLADE**  
D2 PTFE nero  
Black PTFE D2  
HRC 59-61

**DISTANZIALE | SPACER**  
G10 nero  
Black G10

**MANICO | HANDLE**  
G10 nero  
Black G10

**CLIP**  
Sagomata in acciaio inox PTFE nero  
Black PTFE shaped stainless steel

**LINER LOCK**  
Acciaio inox PTFE nero  
Black PTFE stainless steel

**VITI | SCREWS**  
Acciaio inox PTFE nero  
Black PTFE stainless steel





**SPECTRUM**  
**BF-782 OR**  
LINER LOCK

NEW ITEM

120 g - 4.23 oz



20 cm - 7.87"



3 mm - 0.12"



9 cm - 3.54"



- D2 satinato  
Satin D2  
HRC 59-61
- G10 nero  
Black G10
- Acciaio inox lucido  
Polished stainless steel
- G10 nero  
Black G10
- Sagomata in acciaio inox lucido  
Polished shaped stainless steel
- Acciaio inox lucido  
Polished stainless steel



**SPEAR**  
**BF-783 ZW**  
LINER LOCK

NEW ITEM

68 g - 2.39 oz



17,5 cm - 6.89"



3 mm - 0.12"



7 cm - 2.75"



- D2 satinato  
Satin D2  
HRC 59-61
- Zebrano  
Zebra wood
- Acciaio inox lucido  
Polished stainless steel
- Acciaio inox lucido  
Polished stainless steel
- Sagomata in acciaio inox lucido  
Polished shaped stainless steel
- Acciaio inox lucido  
Polished stainless steel



**SPEAR**  
**BF-783 G10**  
LINER LOCK

NEW ITEM

80 g - 2.82 oz



17,5 cm - 6.89"



3 mm - 0.12"



7 cm - 2.75"



- D2 satinato  
Satin D2  
HRC 59-61
- G10 nero  
Black G10
- Acciaio inox lucido  
Polished stainless steel
- G10 nero  
Black G10
- Sagomata in acciaio inox lucido  
Polished shaped stainless steel
- Acciaio inox lucido  
Polished stainless steel



**TEENY**  
**BF-785 MIBL**  
LINER LOCK

NEW ITEM

75 g - 2.64 oz



13,30 cm - 5.24"



3 mm - 0.12"



5,5 cm - 2.17"



- D2 satinato  
Satin D2  
HRC 59-61
- Micarta blu  
Blue Micarta
- Acciaio inox lucido  
Polished stainless steel
- Acciaio inox lucido  
Polished stainless steel
- A filo in acciaio inox lucido  
Polished wire clip stainless steel
- Acciaio inox lucido  
Polished stainless steel



**TEENY**  
**BF-785 G10**  
LINER LOCK

NEW ITEM

75 g - 2.64 oz



13,30 cm - 5.24"



3 mm - 0.12"



5,5 cm - 2.17"



- D2 satinato  
Satin D2  
HRC 59-61
- G10 nero  
Black G10
- Acciaio inox lucido  
Polished stainless steel
- Acciaio inox lucido  
Polished stainless steel
- A filo in acciaio inox lucido  
Polished wire clip stainless steel
- Acciaio inox lucido  
Polished stainless steel



**MOMENTUM**  
**BF-769**  
LINER LOCK

NEW ITEM

95 gr - 3.35 oz



20 cm - 7.87"



3 mm - 0.12"



9 cm - 3.54"



- D2 PTFE nero  
Black PTFE D2  
HRC 59-61
- G10 nero  
Black G10
- Acciaio inox PTFE nero  
Black PTFE stainless steel
- Alluminio anodizzato arancione  
Orange anodized aluminium
- Sagomata in acciaio inox PTFE nero  
Black PTFE shaped stainless steel
- Acciaio inox lucido  
Polished stainless steel



Nylon®

## DEMAND BF-784 OR LINER LOCK

NEW  
ITEM

185 g - 6.52 oz



20 cm - 7.87"



3 mm - 0.12"



8,5 cm - 3.34"



D2 stone washed  
Stone washed D2  
HRC 59-61

Alluminio anodizzato arancione  
Orange anodized aluminum

Acciaio inox lucido  
Polished stainless steel

Acciaio inox lucido  
Polished stainless steel

Sagomata in acciaio inox lucido  
Polished shaped stainless steel

Acciaio inox lucido  
Polished stainless steel

Frangivetro acciaio inox  
Stainless steel glass breaker



Nylon®

## BF-115 LINER LOCK

145 g - 5.11 oz



20,8 cm - 8.20"



3 mm - 0.12"



9 cm - 3.54"



AISI 440A PVD nero  
Black PVD AISI 440A  
HRC 55-57

G10 nero  
Black G10

Acciaio inox PTFE nero  
Black PTFE stainless steel

Acciaio inox PTFE nero  
Black PTFE stainless steel

Acciaio inox PTFE nero  
Black PTFE stainless steel

Frangivetro acciaio inox  
PTFE nero  
Black PTFE stainless steel  
glass breaker



Nylon®

## BF-117 LINER LOCK

155 g - 5.46 oz



20,8 cm - 8.20"



3 mm - 0.12"



9 cm - 3.54"



AISI 440A satinato  
Satin AISI 440A  
HRC 55-57

Alluminio anodizzato rosso  
Red anodized aluminum

Acciaio inox lucido  
Polished stainless steel

Acciaio inox lucido  
Polished stainless steel

Acciaio inox lucido  
Polished stainless steel

Frangivetro acciaio inox  
Stainless steel glass breaker



## ACUTUS

designed by Grigorii Matveev

### BF-764 BB LINER LOCK

**LAMA | BLADE**  
D2 PTFE nero  
Black PTFE D2  
HRC 59-61

**MANICO | HANDLE**  
G10 nero  
Black G10

**LINER LOCK**  
Acciaio inox PTFE nero  
Black PTFE stainless steel

**DISTANZIALE | SPACER**  
Acciaio inox PTFE nero  
Black PTFE stainless steel

**CLIP**  
Sagomata in acciaio inox  
PTFE nero  
Black PTFE shaped  
stainless steel

**VITI | SCREWS**  
Acciaio inox PTFE nero  
Black PTFE stainless steel

8,2 cm - 3.23"

3,4 mm - 0.13"

19,6 cm - 7.72"

115 g - 4.05 oz



## ARTIA

designed by Grigorii Matveev

### BF-765 LINER LOCK

**LAMA | BLADE**  
D2 PTFE nero  
Black PTFE D2  
HRC 59-61

**MANICO | HANDLE**  
G10 nero  
Black G10

**LINER LOCK**  
Acciaio inox PTFE nero  
Black PTFE stainless steel

**DISTANZIALE | SPACER**  
Acciaio inox PTFE nero  
Black PTFE stainless steel

**CLIP**  
Sagomata in acciaio inox  
PTFE nero  
Black PTFE shaped  
stainless steel

**VITI | SCREWS**  
Acciaio inox PTFE nero  
Black PTFE stainless steel

8,5 cm - 3.35"

3,4 mm - 0.13"

20,3 cm - 7.99"

100 g - 3.52 oz



## ACUTUS

designed by Grigorii Matveev

### BF-764 OD LINER LOCK

**LAMA | BLADE**  
D2 PTFE nero stone washed  
Black PTFE stone washed D2  
HRC 59-61

**MANICO | HANDLE**  
G10 verde OD  
OD green G10

**LINER LOCK**  
Acciaio inox lucido  
Polished stainless steel

**DISTANZIALE | SPACER**  
Acciaio inox PTFE nero  
Black PTFE stainless steel

**CLIP**  
Sagomata in acciaio  
inox lucido  
Polished shaped  
stainless steel

**VITI | SCREWS**  
Acciaio inox lucido  
Polished stainless steel

8,2 cm - 3.23"

3,4 mm - 0.13"

19,6 cm - 7.72"

115 g - 4.05 oz



## ARTIA

designed by Grigorii Matveev

### BF-765 OD LINER LOCK

**LAMA | BLADE**  
D2 stone washed  
Stone washed D2  
HRC 59-61

**MANICO | HANDLE**  
G10 verde OD  
OD green G10

**LINER LOCK**  
Acciaio inox lucido  
Polished stainless steel

**DISTANZIALE | SPACER**  
Acciaio inox PTFE nero  
Black PTFE stainless steel

**CLIP**  
Sagomata in acciaio  
inox lucido  
Polished shaped  
stainless steel

**VITI | SCREWS**  
Acciaio inox lucido  
Polished stainless steel

8,5 cm - 3.35"

3,4 mm - 0.13"

20,3 cm - 7.99"

100 g - 3.52 oz

**FERESA**

designed by Grigorii Matveev

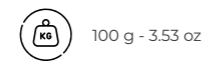
**BF-762 BB**  
LINER LOCK**LAMA | BLADE**D2 PTFE nero stone washed  
Black PTFE stone washed D2  
HRC 59-61**DISTANZIALE | SPACER**Alluminio anodizzato nero  
Black anodized aluminium**MANICO | HANDLE**Alluminio anodizzato nero  
Black anodized aluminium**CLIP**Sagomata in acciaio inox  
PTFE nero  
Black PTFE shaped  
stainless steel**LINER LOCK**Acciaio inox PTFE nero  
Black PTFE stainless steel**VITI | SCREWS**Acciaio inox PTFE nero  
Black PTFE stainless steel**ARGUS**

designed by Grigorii Matveev

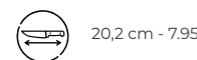
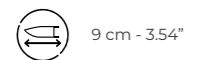
**BF-760**  
LINER LOCK**LAMA | BLADE**D2 PTFE nero stone washed  
Black PTFE stone washed D2  
HRC 59-61**DISTANZIALE | SPACER**Alluminio anodizzato blu  
Blue anodized aluminium**MANICO | HANDLE**G10 nero  
Black G10**CLIP**Sagomata in acciaio inox  
PTFE nero  
Black PTFE shaped  
stainless steel**LINER LOCK**Acciaio inox PTFE nero  
Black PTFE stainless steel**VITI | SCREWS**Acciaio inox PTFE nero  
Black PTFE stainless steel**FERESA**

designed by Grigorii Matveev

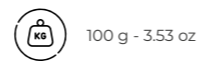
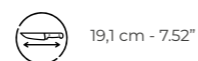
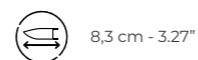
**BF-762 OD**  
LINER LOCK**LAMA | BLADE**D2 PTFE nero stone washed  
Black PTFE stone washed D2  
HRC 59-61**DISTANZIALE | SPACER**Alluminio anodizzato nero  
Black anodized aluminium**MANICO | HANDLE**Alluminio anodizzato  
verde menta  
Mint green anodized  
aluminium**CLIP**Sagomata in acciaio  
inox lucido  
Polished shaped  
stainless steel**LINER LOCK**Acciaio inox PTFE nero  
Black PTFE stainless steel**VITI | SCREWS**Acciaio inox PTFE nero  
Black PTFE stainless steel**ARGUS**

designed by Grigorii Matveev

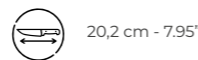
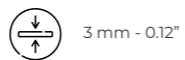
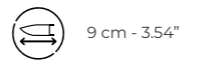
**BF-760 W**  
LINER LOCK**LAMA | BLADE**D2 satinato  
Satin D2  
HRC 59-61**DISTANZIALE | SPACER**Ottone  
Brass**MANICO | HANDLE**Zebrano  
Zebra wood**CLIP**Sagomata in acciaio  
inox lucido  
Polished shaped  
stainless steel**LINER LOCK**Acciaio inox lucido  
Polished stainless steel**VITI | SCREWS**Acciaio inox lucido  
Polished stainless steel**BF-748**  
CIOL

designed by Anarcnide

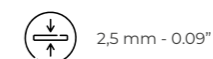
**BF-748 CR**  
SLIP JOINT**LAMA | BLADE**AISI 440C PTFE nero stone washed  
Black PTFE stone washed AISI 440C  
HRC 57-59**SLIP JOINT**AISI 420 lucido  
Polished AISI 420**MANICO | HANDLE**Rame stone washed  
Stone washed copper**VITI | SCREWS**Acciaio inox con PTFE nero  
Black PTFE stainless steelCuoio nero  
Black leather**BF-748 MI**  
SLIP JOINT**LAMA | BLADE**440C stone washed  
Stone washed 440C  
HRC 57-59**SLIP JOINT**AISI 420 lucido  
Polished AISI 420**MANICO | HANDLE**Micarta verde OD  
OD green Micarta**VITI | SCREWS**Acciaio inox lucido  
Polished stainless steelCuoio nero  
Black leather**BF-748 MIB**  
SLIP JOINT**LAMA | BLADE**440C stone washed  
Stone washed 440C  
HRC 57-59**SLIP JOINT**AISI 420 lucido  
Polished AISI 420**MANICO | HANDLE**Micarta marrone  
Brown Micarta**VITI | SCREWS**Acciaio inox lucido  
Polished stainless steel

# BF-758 NU-BOWIE

designed by Keanu Alfaro

BLACK FOX

## BF-758 BUTTON LOCK



90 g - 3.17 oz



15 cm - 5.9"



3 mm - 0.12"



6 cm - 2.36"



D2 PTFE nero  
Black PTFE D2  
HRC 59-61

G10 nero  
Black G10

Acciaio inox PTFE nero  
Black PTFE stainless steel

Acciaio inox PTFE nero  
Black PTFE stainless steel

Sagomata in acciaio inox PTFE nero  
Black PTFE shaped stainless steel

Acciaio inox PTFE nero  
Black PTFE stainless steel

## BF-758 MI BUTTON LOCK



80 g - 2.82 oz



15 cm - 5.9"



3 mm - 0.12"



6 cm - 2.36"



D2 stone washed  
Stone washed D2  
HRC 59-61

Micarta verde OD  
OD green Micarta

Acciaio inox lucido  
Polished stainless steel

Acciaio inox lucido  
Polished stainless steel

Sagomata in acciaio inox lucido  
Polished shaped stainless steel

Acciaio inox lucido  
Polished stainless steel

## BF-758 MIB BUTTON LOCK



80 g - 2.82 oz



15 cm - 5.9"



3 mm - 0.12"



6 cm - 2.36"



D2 stone washed  
Stone washed D2  
HRC 59-61

Micarta marrone  
Brown Micarta

Acciaio inox lucido  
Polished stainless steel

Acciaio inox lucido  
Polished stainless steel

Sagomata in acciaio inox lucido  
Polished shaped stainless steel

Acciaio inox lucido  
Polished stainless steel

# BF-763 NIX

designed by Grigorii Matveev

BLACK FOX

## BF-763 CF LINER LOCK



75 g - 2.64 oz



13,30 cm - 5.24"



3 mm - 0.12"



5,5 cm - 2.17"



D2 satinato  
Satin D2  
HRC 59-61

Fibra di carbonio  
Carbon fiber

Acciaio inox lucido  
Polished stainless steel

Alluminio anodizzato rosso  
Red anodized aluminium

Sagomata in acciaio inox lucido  
Polished shaped stainless steel

Acciaio inox lucido  
Polished stainless steel

## BF-763 OR LINER LOCK



75 g - 2.64 oz



13,30 cm - 5.24"



3 mm - 0.12"



5,5 cm - 2.17"



D2 PTFE nero stone washed  
Black PTFE stone washed D2  
HRC 59-61

G10 arancione  
Orange G10

Acciaio inox PTFE nero  
Black PTFE stainless steel

Acciaio inox PTFE nero  
Black PTFE stainless steel

Sagomata in acciaio inox PTFE nero  
Black PTFE shaped stainless steel

Acciaio inox PTFE nero  
Black PTFE stainless steel

## BF-763 LINER LOCK



90 g - 3.17 oz



13,30 cm - 5.24"



3 mm - 0.12"



5,5 cm - 2.17"



D2 acid stone washed  
Acid stone washed D2  
HRC 59-61

Micarta marrone  
Brown Micarta

Acciaio inox lucido  
Polished stainless steel

Acciaio inox lucido  
Polished stainless steel

Sagomata in acciaio inox lucido  
Polished shaped stainless steel

Acciaio inox PTFE marrone  
Brown PTFE stainless steel



**PUCK**  
designed by Grigorii Matveev  
**BF-761 R**  
LINER LOCK

**LAMA | BLADE**  
D2 PTFE nero stone washed  
Black PTFE stone washed D2  
HRC 59-61

**MANICO | HANDLE**  
G10 rosso  
Red G10

**FRAME LOCK**  
Acciaio inox PTFE nero  
Black PTFE stainless steel

**DISTANZIALE | SPACER**  
Alluminio anodizzato nero  
Black anodized aluminium

**CLIP**  
Sagomata in acciaio inox  
PTFE nero  
Black PTFE shaped stainless steel

**VITI | SCREWS**  
Acciaio inox PTFE nero  
Black PTFE stainless steel

5 cm - 1.96" 3 mm - 0.12"

10,7 cm - 4.21" 70 g - 2.46 oz



**PUCK**  
designed by Grigorii Matveev  
**BF-761 OR**  
LINER LOCK

**LAMA | BLADE**  
D2 PTFE nero stone washed  
Black PTFE stone washed D2  
HRC 59-61

**MANICO | HANDLE**  
G10 arancione  
Orange G10

**FRAME LOCK**  
Acciaio inox PTFE nero  
Black PTFE stainless steel

**DISTANZIALE | SPACER**  
Alluminio anodizzato nero  
Black anodized aluminium

**CLIP**  
Sagomata in acciaio inox  
PTFE nero  
Black PTFE shaped stainless steel

**VITI | SCREWS**  
Acciaio inox PTFE nero  
Black PTFE stainless steel

5 cm - 1.96" 3 mm - 0.12"

10,7 cm - 4.21" 70 g - 2.46 oz



**KIT**  
**BF-752**  
FRAME LOCK

**LAMA | BLADE**  
AISI 440C stone washed  
Stone washed AISI 440C  
HRC 55-57

**MANICO | HANDLE**  
G10 nero  
Black G10

**FRAME LOCK**  
AISI 420 lucido  
Polished AISI 420

5 cm - 1.96" 3 mm - 0.12"

11,5 cm - 5.31" 70 g - 2.46 oz



**KIT**  
**BF-752 OD**  
FRAME LOCK

**LAMA | BLADE**  
AISI 440C stone washed  
Stone washed AISI 440C  
HRC 55-57

**MANICO | HANDLE**  
G10 verde OD  
OD green G10

**FRAME LOCK**  
AISI 420 lucido  
Polished AISI 420

5 cm - 1.96" 3 mm - 0.12"

11,5 cm - 5.31" 70 g - 2.46 oz



**B.KEY**  
designed by Beric Design  
**BF-750**  
LINER LOCK

**LAMA | BLADE**  
AISI 440A stone washed  
Stone washed AISI 440A  
HRC 55-57

**MANICO | HANDLE**  
Alluminio anodizzato nero  
Black anodized aluminium

**LINER LOCK**  
AISI 420 lucido  
Polished AISI 420

**CLIP**  
Sagomata in AISI 303 lucido  
Polished shaped AISI 303

**VITI | SCREWS**  
Acciaio inox lucido  
Polished stainless steel

4,5 cm - 1.77"

4 mm - 0.15"

10,5 cm - 4.13"

70 g - 2.46 oz



**B.KEY**  
designed by Beric Design  
**BF-750 BL**  
LINER LOCK

**LAMA | BLADE**  
AISI 440A stone washed  
Stone washed AISI 440A  
HRC 55-57

**MANICO | HANDLE**  
Alluminio anodizzato blu  
Blue anodized aluminium

**LINER LOCK**  
AISI 420 lucido  
Polished AISI 420

**CLIP**  
Sagomata in AISI 303 lucido  
Polished shaped AISI 303

**VITI | SCREWS**  
Acciaio inox lucido  
Polished stainless steel

4,5 cm - 1.77"

4 mm - 0.15"

10,5 cm - 4.13"

70 g - 2.46 oz



**B.KEY**  
designed by Beric Design  
**BF-750 OD**  
LINER LOCK

**LAMA | BLADE**  
AISI 440A stone washed  
Stone washed AISI 440A  
HRC 55-57

**MANICO | HANDLE**  
Alluminio anodizzato verde OD  
OD green anodized aluminium

**LINER LOCK**  
AISI 420 lucido  
Polished AISI 420

**CLIP**  
Sagomata in AISI 303 lucido  
Polished shaped AISI 303

**VITI | SCREWS**  
Acciaio inox lucido  
Polished stainless steel

4,5 cm - 1.77"

4 mm - 0.15"

10,5 cm - 4.13"

70 g - 2.46 oz



**O.KEY**  
designed by Beric Design  
**BF-751**  
LINER LOCK

**LAMA | BLADE**  
AISI 440A stone washed  
Stone washed AISI 440A  
HRC 55-57

**MANICO | HANDLE**  
Alluminio anodizzato nero  
Black anodized aluminium

**LINER LOCK**  
AISI 420 lucido  
Polished AISI 420

**CLIP**  
Sagomata in AISI 303 lucido  
Polished shaped AISI 303

**VITI | SCREWS**  
Acciaio inox lucido  
Polished stainless steel

4,5 cm - 1.77"

4 mm - 0.15"

10,5 cm - 4.13"

70 g - 2.46 oz



**O.KEY**  
designed by Beric Design  
**BF-751 BL**  
LINER LOCK

**LAMA | BLADE**  
AISI 440A stone washed  
Stone washed AISI 440A  
HRC 55-57

**MANICO | HANDLE**  
Alluminio anodizzato blu  
Blue anodized aluminium

**LINER LOCK**  
AISI 420 lucido  
Polished AISI 420

**CLIP**  
Sagomata in AISI 303 lucido  
Polished shaped AISI 303

**VITI | SCREWS**  
Acciaio inox lucido  
Polished stainless steel

4,5 cm - 1.77"

4 mm - 0.15"

10,5 cm - 4.13"

70 g - 2.46 oz



**O.KEY**  
designed by Beric Design  
**BF-751 O**  
LINER LOCK

**LAMA | BLADE**  
AISI 440A stone washed  
Stone washed AISI 440A  
HRC 55-57

**MANICO | HANDLE**  
Alluminio anodizzato arancione  
Orange anodized aluminium

**LINER LOCK**  
AISI 420 lucido  
Polished AISI 420

**CLIP**  
Sagomata in AISI 303 lucido  
Polished shaped AISI 303

**VITI | SCREWS**  
Acciaio inox lucido  
Polished stainless steel

4,5 cm - 1.77"

4 mm - 0.15"

10,5 cm - 4.13"

70 g - 2.46 oz



**BEAN GEN 2**

designed by Serge Panchenko

**BF-719 G10**

SLIP JOINT

**LAMA | BLADE**

AISI 440C PTFE nero  
stone washed  
Black PTFE stone washed  
AISI 440C  
HRC 57-59

**CLIP**

Sagomata in AISI 420 PTFE  
nero stone washed  
Black PTFE stone washed  
shaped AISI 420

**MANICO | HANDLE**

G10 nero  
Black G10

**VITI | SCREWS**

Acciaio inox PTFE nero  
Black PTFE stainless steel

**SLIP JOINT**

AISI 420 PTFE nero stone  
washed Black PTFE stone  
washed AISI 420

**BEAN GEN 2**

designed by Serge Panchenko

**BF-719 MI**

SLIP JOINT

**LAMA | BLADE**

AISI 440C satinato  
Satin AISI 440C  
HRC 57-59

**CLIP**

Sagomata in AISI 420  
lucido  
Polished shaped AISI 420

**MANICO | HANDLE**

Micarta verde OD  
OD green Micarta

**VITI | SCREWS**

Acciaio inox lucido  
Polished stainless steel

**SLIP JOINT**

AISI 420 lucido  
Polished AISI 420

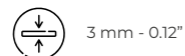
**BEAN GEN 2**

designed by Serge Panchenko

**BF-719 MIN**

SLIP JOINT

**LAMA | BLADE**

AISI 440C satinato  
Satin AISI 440C  
HRC 57-59

**CLIP**

Sagomata in AISI 420  
lucido  
Polished shaped AISI 420

**MANICO | HANDLE**

Micarta naturale  
Natural Micarta

**VITI | SCREWS**

Acciaio inox lucido  
Polished stainless steel

**SLIP JOINT**

AISI 420 lucido  
Polished AISI 420

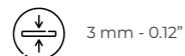
**BEAN GEN 2**

designed by Serge Panchenko

**BF-719 ZW**

SLIP JOINT

**LAMA | BLADE**

AISI 440C satinato  
Satin AISI 440C  
HRC 57-59

**CLIP**

Sagomata in AISI 420  
lucido  
Polished shaped AISI 420

**MANICO | HANDLE**

Zebrano  
Zebra wood

**VITI | SCREWS**

Acciaio inox lucido  
Polished stainless steel

**SLIP JOINT**

AISI 420 lucido  
Polished AISI 420

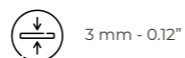
**KRAVI SHAI**

designed by Avi Nardia

**BF-729**

LINER LOCK

**LAMA | BLADE**

AISI 440C PVD nero stone washed  
Black PVD stone washed AISI 440C  
HRC 57-59

**MANICO | HANDLE**

G10 nero  
Black G10

**LINER LOCK**

AISI 420 PTFE nero  
Black PTFE AISI 420

**CLIP**

Sagomata in AISI 420  
PTFE nero  
Black PTFE shaped AISI 420

**VITI | SCREWS**

Acciaio inox lucido  
Polished stainless steel

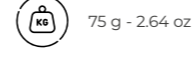
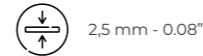
**STEELIX****BF-717**

FRAME LOCK

**LAMA | BLADE**

AISI 440C stone washed  
Stone washed AISI 440C  
HRC 57-59

**MANICO | HANDLE**

AISI 420 stone washed  
Stone washed AISI 420

**FRAME LOCK**

AISI 420 stone washed  
Stone washed AISI 420

**CLIP**

Sagomata AISI 420 stone  
washed  
Stone washed shaped AISI 420

**VITI | SCREWS**

Acciaio inox lucido  
Polished stainless steel

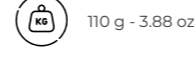
**KRAVI SHAI**

designed by Avi Nardia

**BF-729 SW**

LINER LOCK

**LAMA | BLADE**

AISI 440C stone washed  
Stone washed AISI 440C  
HRC 57-59

**MANICO | HANDLE**

G10 nero  
Black G10

**LINER LOCK**

AISI 420 stone washed  
Stone washed AISI 420

**CLIP**

Sagomata AISI 420 stone  
washed  
Stone washed shaped AISI 420

**VITI | SCREWS**

Acciaio inox lucido  
Polished stainless steel

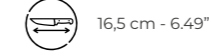
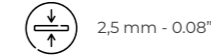
**NIDHUG**

designed by Mikkel Wilumsen

**BF-714 OR**

SLIP JOINT

**LAMA | BLADE**

AISI 440A satinato  
Satin AISI 440A  
HRC 55-57

**MANICO | HANDLE**

G10 arancione  
Orange G10

**SLIP JOINT**

AISI 420 lucido  
Polished AISI 420

**CLIP**

Sagomata in AISI  
420 lucido  
Polished shaped AISI 420

**VITI | SCREWS**

Acciaio inox lucido  
Polished stainless steel

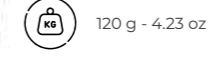
**BF-237**

SLIP JOINT

**LAMA | BLADE**

AISI 420 satinato  
Satin AISI 420  
HRC 54-55

**MANICO | HANDLE**

AISI 420 satinato  
Satin AISI 420

**RIVETTI | RIVETS**

Ottone lucido  
Polished brass

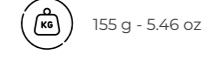



designed by Moris Baroni

### BF-80 LINER LOCK

#### LAMA | BLADE

AISI 440A PVD nero  
Black PVD AISI 440A  
HRC 55-57

#### LINER LOCK

AISI 420 PVD nero  
Black PVD AISI 420

#### VITI | SCREWS

Acciaio inox PTFE nero  
Black PTFE stainless steel

#### MANICO | HANDLE

Zytel nero  
Black Zytel

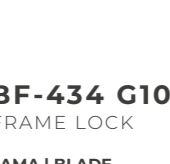
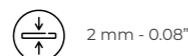

### BF-434 G10 FRAME LOCK

#### LAMA | BLADE

AISI 440A PVD nero  
Black PVD AISI 440A  
HRC 55-57

#### MANICO | HANDLE

G10 nero  
Black G10

#### FRAME LOCK

AISI 420 PVD nero  
Black PVD AISI 420

#### CLIP

Sagomata in AISI 420 PVD nero  
Black PVD shaped AISI 420

#### VITI | SCREWS

Acciaio inox PVD nero  
Black PVD stainless steel

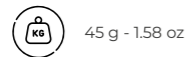
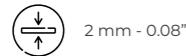

### BF-434 ZW FRAME LOCK

#### LAMA | BLADE

AISI 440A satinato  
Satin AISI 440A  
HRC 55-57

#### MANICO | HANDLE

Zebrano  
Zebra wood

#### FRAME LOCK

AISI 420 satinato  
Satin AISI 420

#### CLIP

Sagomata in AISI 420 lucido  
Polished shaped AISI 420

#### VITI | SCREWS

Acciaio inox lucido  
Polished stainless steel

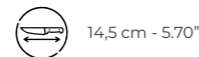

designed by Moris Baroni

### BF-81 LINER LOCK

#### LAMA | BLADE

AISI 440A PVD nero  
Black PVD AISI 440A  
HRC 55-57

#### LINER LOCK

AISI 420 PVD nero  
Black PVD AISI 420

#### VITI | SCREWS

Acciaio inox PTFE nero  
Black PTFE stainless steel

#### MANICO | HANDLE

Zytel nero  
Black Zytel

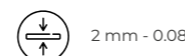

### BF-105T BACK LOCK

#### LAMA | BLADE

AISI 440A PVD nero  
Black PVD AISI 440A  
HRC 55-57

#### MANICO | HANDLE

G10 nero  
Black G10

#### BACK LOCK

AISI 420 PVD nero  
Black PVD shaped AISI 420

#### CLIP

Sagomata in AISI 420 PVD nero  
Black PVD shaped AISI 420

#### VITI | SCREWS

Acciaio inox PVD nero  
Black PVD stainless steel

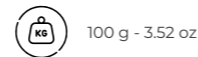
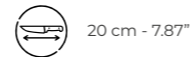
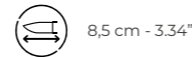

Kydex®

### VESUVIUS

designed by Alfredo Doricchi

### BF-710 D2 FIXED BLADE

#### LAMA | BLADE

D2 stone washed  
Stone washed D2  
HRC 59-61

#### MANICO | HANDLE

G10 nero  
Black G10

#### BOCCOLE | BUSHINGS

Acciaio inox lucido  
Polished stainless steel

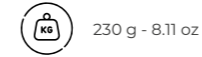
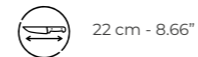

Kydex®

### VIATOR

designed by Alfredo Doricchi

### BF-731 D2 MG FIXED BLADE

#### LAMA | BLADE

D2 satinato  
Satin D2  
HRC 59-61

#### MANICO | HANDLE

Micarta grigia  
Grey Micarta

#### BOCCOLE | BUSHINGS

Acciaio inox lucido  
Polished stainless steel

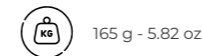
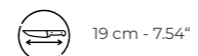
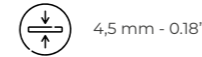
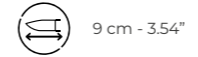

Kydex®

### VESUVIUS

designed by Alfredo Doricchi

### BF-710 D2 OD FIXED BLADE

#### LAMA | BLADE

D2 stone washed  
Stone washed D2  
HRC 59-61

#### MANICO | HANDLE

G10 verde OD  
OD green G10

#### BOCCOLE | BUSHINGS

Acciaio inox lucido  
Polished stainless steel



Kydex®

### EXPLORATOR

designed by Alfredo Doricchi

### BF-749 FIXED BLADE

#### LAMA | BLADE

AISI 440C stone washed  
Stone washed AISI 440C  
HRC 57-59

#### MANICO | HANDLE

Micarta marrone  
Brown Micarta

#### VITI | SCREWS

Acciaio inox lucido  
Polished stainless steel





Kydex®

**GOLEM**

designed by Anarcnide

**BF-757 OD**  
FIXED BLADE**LAMA | BLADE**  
D2 stone washed  
Stone washed D2  
HRC 59-61**MANICO | HANDLE**  
G10 verde OD  
OD green G10**VITI | SCREWS**  
Acciaio inox lucido  
Polished stainless steel

14.5 cm - 5.71"
 5 mm - 0.20"

27 cm - 10.63"
 290 g - 0.64 oz

Cuio marrone  
Brown leather**COMPANION****BF-741**  
FIXED BLADE**LAMA | BLADE**  
D2 satinato  
Satin D2  
HRC 57-59**MANICO | HANDLE**  
Pakkawood**VITI | SCREWS**  
Acciaio inox lucido  
Polished stainless steel

11 cm - 4.33"
 4 mm - 0.16"

23 cm - 9.05"
 165 g - 5.82 oz



Kydex®

**SPIKE**

designed by Serge Panchenko

**BF-728**  
FIXED BLADE**LAMA | BLADE**  
AISI 440C PVD nero  
Black PVD AISI 440C  
HRC 57-59**MANICO | HANDLE**  
G10 nero  
Black G10**VITI | SCREWS**  
Acciaio inox PTFE nero  
Black PTFE stainless steel

4 cm - 1.57"
 4,5 mm - 0.18"

10,5 cm - 4.13"
 50 g - 1.76 oz



Kydex®

**MICRO**

designed by Alfredo Doricchi

**BF-712**  
FIXED BLADE**LAMA | BLADE**  
AISI 440C satinato  
Satin AISI 440C  
HRC 57-59**MANICO | HANDLE**  
Corda di Nylon®  
Nylon® cord

4 cm - 1.57"
 3,5 mm - 0.14"

10,5 cm - 4.13"
 50 g - 1.76 oz



Kydex®

**BF-753**  
FIXED BLADE**LAMA | BLADE**  
AISI 440C PTFE nero stone washed  
Black PTFE stone washed AISI 440C  
HRC 57-59**MANICO | HANDLE**  
G10 nero  
Black G10**BOCCOLE | BUSHINGS**  
Acciaio inox lucido  
Polished stainless steel

5,5 cm - 2.16"

3,5 mm - 4.06 oz

11,5 cm - 4.52"

71 g - 4.06 oz



Kydex®

**BF-754**  
FIXED BLADE**LAMA | BLADE**  
AISI 440C PTFE nero stone washed  
Black PTFE stone washed AISI 440C  
HRC 57-59**MANICO | HANDLE**  
G10 nero  
Black G10**BOCCOLE | BUSHINGS**  
Acciaio inox lucido  
Polished stainless steel

5,5 cm - 2.16"

3,5 mm - 4.06 oz

11,5 cm - 4.52"

80 g - 8.46 oz



Kydex®

**BF-755**  
FIXED BLADE**LAMA | BLADE**  
AISI 440C PTFE nero stone washed  
Black PTFE stone washed AISI 440C  
HRC 57-59**MANICO | HANDLE**  
G10 nero  
Black G10**BOCCOLE | BUSHINGS**  
Acciaio inox lucido  
Polished stainless steel

5,5 cm - 2.16"

3,5 mm - 4.06 oz

11,5 cm - 4.52"

71 g - 4.06 oz

Fodero in Kydex® TEK-LOK clip  
Kydex® sheath TEK-LOK clip**EVOLUTION TOMAHAWK****BF-735**  
FIXED BLADE**LAMA | BLADE**  
AISI 440C PTFE nero stone washed  
Black PTFE stone washed AISI 440C  
HRC 57-59**MANICO | HANDLE**  
G10 nero  
Black G10**VITI | SCREWS**  
Acciaio inox PTFE nero  
Black PTFE stainless steel

7,5 cm - 2.95"
 7 mm - 0.28"

27 cm - 10.62"
 515 g - 18.16 oz



### ENDURANCE BF-203



Nylon®

#### STRUMENTI | TOOLS

- Pinza / Pliers
- Tagliafili / Wire cutter
- Lama / Blade 8 cm - 3.14"
- Forbici / Scissors
- Taglierino / Cutter
- Apribottiglie con cacciavite a testa piatta / Bottle opener with flat screwdriver
- Apriscatole con cacciavite a testa piatta / Can opener with flat screwdriver
- Cacciavite a croce con chiusura di sicurezza / Phillips screwdriver with locking system
- Punteruolo / Awl
- Lima per unghie / Nail file
- Sega / Saw



17,5 cm - 6.88"



265 g - 9.34 oz



### RESILIENCE BF-204



Nylon®

#### STRUMENTI | TOOLS

- Pinze / Pliers
- Tagliafili / Wire cutter
- Lama / Blade 8 cm - 3.14"
- Forbici / Scissors
- Taglierino / Multipurpose cutter
- Apribottiglie con cacciavite a testa piatta / Bottle opener with flat screwdriver
- Apriscatole con cacciavite a testa piatta / Can opener with flat screwdriver
- Cacciavite a croce / Phillips screwdriver
- Punteruolo / Awl
- Clip



17,5 cm - 6.88"



269 g - 9.48 oz

### BF-206 FORTITUDE

NEW  
ITEM

17,5 cm - 6.88"



272 g - 9.59 oz



#### STRUMENTI | TOOLS

- Pinze / Pliers
- Tagliafili / Wire cutter
- Punzone per cuoio / Leather punch
- Cacciavite a croce / Phillips screwdriver
- Apribottiglie / Bottle opener
- Apriscatole / Can opener
- Taglierina / Cutter
- Lima / Metal file
- Cacciavite piatto piccolo / Small flat screwdriver
- Attacco portachiavi / Keychain attachment
- Sega / Saw
- Lama seghettata / Serrated blade
- Lama / Blade 8 cm - 3.14"
- Forbici / Scissors
- Pietra focaia / Flint stone
- Clip



Nylon®



### BF-207 SOLVER

NEW  
ITEM

17,5 cm - 6.88"



137 g - 4.68 oz



#### STRUMENTI | TOOLS

- Lama / Blade 5,5 cm - 2.16"
- Lama dentata / Serrated blade
- Forbici / Scissors
- Seghetto / Saw
- Apribottiglie / Bottle opener
- Apriscatole / Can opener
- Spelafili / Wire stripper
- Punzone per cuoio / Leather punch
- Lima / Metal file
- Righello / Ruler
- Cacciavite piatto / Flat screwdriver
- Cacciavite a croce / Phillips screwdriver
- Clip

Forbici removibili  
Removable scissors

# BF-205 POCKET BOSS



## MULTIUSO - MULTIPURPOSE BF-205

### STRUMENTI | TOOLS

- Lama / Blade 5 cm - 1.96"
- Forbici / Scissors
- Sega / Saw
- Apri scatole / Can opener
- Lima per unghie / Nail file
- Cacciavite a croce / Philips screw driver
- Attacco portachiavi / Keychain attachment

### LAMA | BLADE

AISI 420 sabbato  
Sandblasted AISI 420

### MANICO | HANDLE

Alluminio nero e ABS nero  
Black aluminium and black ABS



13 cm - 5.11"



83 g - 2.92 oz



## MULTIUSO - MULTIPURPOSE BF-205 OR

### STRUMENTI | TOOLS

- Lama / Blade 5 cm - 1.96"
- Forbici / Scissors
- Sega / Saw
- Apri scatole / Can opener
- Lima per unghie / Nail file
- Cacciavite a croce / Philips screw driver
- Attacco portachiavi / Keychain attachment

### LAMA | BLADE

AISI 420 sabbato  
Sandblasted AISI 420

### MANICO | HANDLE

Alluminio nero e ABS arancione  
Black aluminium and orange ABS



13 cm - 5.11"



83 g - 2.92 oz

# BUSSOLE | COMPASSES

## TS 825

Bussola tascabile / Pocket compass



## TS 815

Bussola / Compass



## TS 819

Bussola militare / Military compass



## TS 816

Bussola / Compass



## TS 828

Bussola con mappa / Map compass



## TS 820

Bussola militare / Military compass





## **FOX EDGE**

Questa linea nasce per soddisfare qualsiasi utente, un assortimento di coltelli chiudibili e a lama fissa dal design accattivante e dalle linee slanciate, ad un prezzo accessibile. Questi coltelli sono pensati per essere dei pratici EDC sempre pronti all'uso: leggeri, versatili, sono utili per supportare tutte le attività quotidiane. Il marchio Fox Edge è garantito grazie all'esperienza delle Coltellerie FOX che produce coltelli dal 1977.

This line was created to satisfy any user, an assortment of folding and fixed blade knives with attractive designs and sleek lines at an affordable price. These knives are designed to be practical EDCs that are always ready to use, lightweight, versatile are useful to support all daily activities. The Fox Edge brand is guaranteed thanks to the experience of FOX Cutlery, which has been manufacturing knives since 1977.



## SPARROW

designed by Anarcnide

**FE-030**  
LINER LOCK

**LAMA | BLADE**  
9Cr13 sabbiato  
Sandblasted 9Cr13  
HRC 57-59

**MANICO | HANDLE**  
Alluminio anodizzato  
azzurro  
Light blue anodized  
aluminium

**LINER LOCK**  
Acciaio inox sabbiato  
Sandblasted stainless steel

**DISTANZIALE | SPACER**  
Acciaio inox sabbiato  
Sandblasted stainless steel

**CLIP**  
Sagomata in acciaio inox  
sabbiato  
Sandblasted shaped  
stainless steel

**VITI | SCREWS**  
Acciaio inox cromato oro  
Gold plated stainless steel

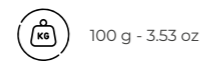
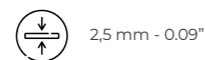
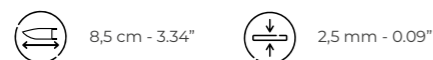

## SPARROW

designed by Anarcnide

**FE-033**  
LINER LOCK

**LAMA | BLADE**  
9Cr13 PTFE nero stone  
washed  
Black PTFE stone washed  
9Cr13  
HRC 57-59

**MANICO | HANDLE**  
G10 verde OD  
G10 OD green

**LINER LOCK**  
Acciaio inox PTFE nero  
stone washed  
Black PTFE stone washed  
stainless steel

**DISTANZIALE | SPACER**  
Acciaio inox PTFE nero  
stone washed  
Black PTFE stone washed  
stainless steel

**CLIP**  
Sagomata in acciaio inox  
PTFE nero stone washed  
Black PTFE stone washed  
shaped stainless steel

**VITI | SCREWS**  
Acciaio inox PTFE nero  
Black PTFE stainless steel

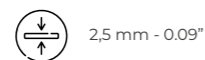
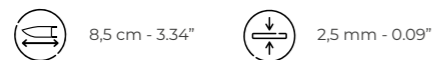

## SPARROW

designed by Anarcnide

**FE-031**  
LINER LOCK

**LAMA | BLADE**  
9Cr13 sabbiato  
Sandblasted 9Cr13  
HRC 57-59

**MANICO | HANDLE**  
Alluminio anodizzato  
bronzo  
Bronze anodized  
aluminium

**LINER LOCK**  
Acciaio inox sabbiato  
Sandblasted stainless steel

**DISTANZIALE | SPACER**  
Acciaio inox sabbiato  
Sandblasted stainless steel

**CLIP**  
Sagomata in acciaio inox  
sabbiato  
Sandblasted shaped  
stainless steel

**VITI | SCREWS**  
Acciaio inox cromato oro  
Gold plated stainless steel

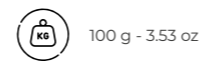
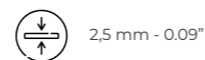
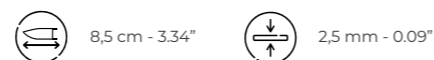

## SPARROW

designed by Anarcnide

**FE-034**  
LINER LOCK

**LAMA | BLADE**  
9Cr13 PTFE nero stone  
washed  
Black PTFE stone washed  
9Cr13  
HRC 57-59

**MANICO | HANDLE**  
G10 nero  
Black G10

**LINER LOCK**  
Acciaio inox PTFE nero  
stone washed  
Black PTFE stone washed  
stainless steel

**DISTANZIALE | SPACER**  
Acciaio inox PTFE nero  
stone washed  
Black PTFE stone washed  
stainless steel

**CLIP**  
Sagomata in acciaio inox  
PTFE nero stone washed  
Black PTFE stone washed  
shaped stainless steel

**VITI | SCREWS**  
Acciaio inox PTFE nero  
Black PTFE stainless steel

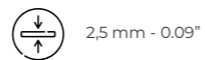

# ATRAX

designed by Anarcnide



**FE-026 AOD**  
LINER LOCK

**LAMA | BLADE**  
8Cr13MOV PTFE nero  
stone washed  
Black PTFE stone washed  
8Cr13MOV  
HRC 57-59

**MANICO | HANDLE**  
Alluminio anodizzato  
verde OD  
OD green anodized  
aluminium

**DISTANZIALE | SPACER**  
G10 verde OD  
G10 OD green

**LINER LOCK**  
AISI 420 PTFE nero  
Black PTFE AISI 420

**CLIP**  
Sagomata in acciaio inox  
PTFE nero stone washed  
Black PTFE stone washed  
shaped stainless steel

**VITI | SCREWS**  
Acciaio inox PTFE nero  
Black PTFE stainless steel



## ATRAX

designed by Anarcnide

**FE-027 MOD**  
LINER LOCK

**LAMA | BLADE**  
8Cr13MOV satinato  
Satin 8Cr13MOV  
HRC 57-59

**MANICO | HANDLE**  
Micarta verde OD  
OD green micarta

**LINER LOCK**  
AISI 420 sabbiato  
Sandblasted AISI 420

**DISTANZIALE | SPACER**  
G10 arancione  
Orange G10

**CLIP**  
Sagomata in acciaio  
sabbiato  
Sandblasted shaped  
stainless steel

**VITI | SCREWS**  
Acciaio inox sabbiato  
Sandblasted stainless steel

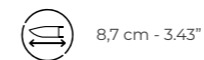

## ATRAX

designed by Anarcnide

**FE-010**  
LINER LOCK

**LAMA | BLADE**  
8Cr13MOV PTFE nero  
stone washed  
Black PTFE stone washed  
8Cr13MOV  
HRC 57-59

**MANICO | HANDLE**  
G10 nero  
Black G10

**LINER LOCK**  
AISI 420 PTFE nero stone  
washed  
Black PTFE stone washed  
AISI 420

**DISTANZIALE | SPACER**  
G10 nero  
Black G10

**CLIP**  
Sagomata in acciaio inox  
PTFE nero stone washed  
Black PTFE stone washed  
shaped stainless steel

**VITI | SCREWS**  
Acciaio inox PTFE nero  
Black PTFE stainless steel





## MANDATORY FUN

designed by Russ Kommer

### FE-024

FRAME LOCK

#### LAMA | BLADE

8Cr13MOV PVD nero stone washed  
Black PVD stone washed  
8Cr13MOV  
HRC 57-59

#### MANICO | HANDLE

G10 nero  
Black G10

#### FRAME LOCK

AISI 420 PVD nero stone washed  
Black PVD stone washed  
AISI 420

#### DISTANZIALE | SPACER

G10 nero  
Black G10

#### CLIP

Sagomata AISI 420 in PVD nero stone washed  
Black PVD stone washed shaped AISI 420

#### VITI | SCREWS

Acciaio inox PTFE nero  
Black PTFE stainless steel

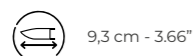

## POP SMOKE

designed by Russ Kommer

### FE-023

FRAME LOCK

#### LAMA | BLADE

8Cr13MOV PVD nero stone washed  
Black PVD stone washed  
8Cr13MOV  
HRC 57-59

#### MANICO | HANDLE

G10 nero  
Black G10

#### FRAME LOCK

AISI 420 PVD nero stone washed  
Black PVD stone washed  
AISI 420

#### DISTANZIALE | SPACER

G10 nero  
Black G10

#### CLIP

Sagomata AISI 420 in PVD nero stone washed  
Black PVD stone washed shaped AISI 420

#### VITI | SCREWS

Acciaio inox PTFE nero  
Black PTFE stainless steel



## MANDATORY FUN

designed by Russ Kommer

### FE-025

FRAME LOCK

#### LAMA | BLADE

8Cr13MOV PVD nero stone washed  
Black PVD stone washed  
8Cr13MOV  
HRC 57-59

#### MANICO | HANDLE

G10 coyote tan  
Coyote tan G10

#### FRAME LOCK

AISI 420 PVD nero stone washed  
Black PVD stone washed  
AISI 420

#### DISTANZIALE | SPACER

G10 nero  
Black G10

#### CLIP

Sagomata AISI 420 in PVD nero stone washed  
Black PVD stone washed shaped AISI 420

#### VITI | SCREWS

Acciaio inox PTFE nero  
Black PTFE stainless steel

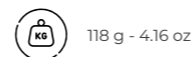
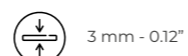
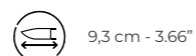

## POP SMOKE

designed by Russ Kommer

### FE-022

FRAME LOCK

#### LAMA | BLADE

8Cr13MOV sabbato  
Sandblasted 8Cr13MOV  
HRC 57-59

#### MANICO | HANDLE

Alluminio sabbato  
Sandblasted aluminium

#### FRAME LOCK

Alluminio sabbato  
Sandblasted aluminium

#### DISTANZIALE | SPACER

Alluminio sabbato  
Sandblasted aluminium

#### CLIP

Sagomata in alluminio sabbato  
Sandblasted shaped aluminium

#### VITI | SCREWS

Acciaio inox PTFE nero  
Black PTFE stainless steel

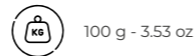
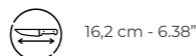
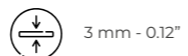
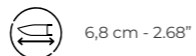

## THE CLAW

designed by Anarcnide

### FE-016

LINER LOCK

#### LAMA | BLADE

8Cr13MOV PVD nero stone washed  
Black PVD stone washed  
8Cr13MOV  
HRC 57-59

#### MANICO | HANDLE

G10 nero  
Black G10

#### LINER LOCK

AISI 420 PVD nero stone washed  
Black PVD stone washed  
AISI 420

#### DISTANZIALE | SPACER

Alluminio anodizzato nero  
Black anodized aluminium

#### CLIP

Sagomata AISI 420 in PVD nero stone washed  
Black PVD stone washed shaped AISI 420

#### VITI | SCREWS

Acciaio inox PTFE nero  
Black PTFE stainless steel

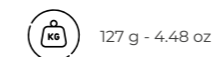

## LYCOSA

designed by Anarcnide

### FE-020

FIXED BLADE

#### LAMA | BLADE

8Cr13MOV PVD nero stone washed  
Black PVD stone washed 8Cr13MOV  
HRC 57-59

#### MANICO | HANDLE

G10 nero  
Black G10

#### VITI | SCREWS

Acciaio inox PTFE nero  
Black PTFE stainless steel



## THE CLAW

designed by Anarcnide

### FE-014

LINER LOCK

#### LAMA | BLADE

8Cr13MOV PVD nero stone washed  
Black PVD stone washed  
8Cr13MOV  
HRC 57-59

#### MANICO | HANDLE

G10 nero  
Black G10

#### LINER LOCK

AISI 420 PVD nero stone washed  
Black PVD stone washed  
AISI 420

#### DISTANZIALE | SPACER

Alluminio anodizzato nero  
Black anodized aluminium

#### CLIP

Sagomata AISI 420 in PVD nero stone washed  
Black PVD stone washed shaped AISI 420

#### VITI | SCREWS

Acciaio inox PTFE nero  
Black PTFE stainless steel



## LYCOSA

designed by Anarcnide

### FE-018

FRAME LOCK

#### LAMA | BLADE

8Cr13MOV PVD nero stone washed  
Black PVD stone washed 8Cr13MOV  
HRC 57-59

#### MANICO | HANDLE

G10 nero  
Black G10

#### VITI | SCREWS

Acciaio inox PTFE nero  
Black PTFE stainless steel

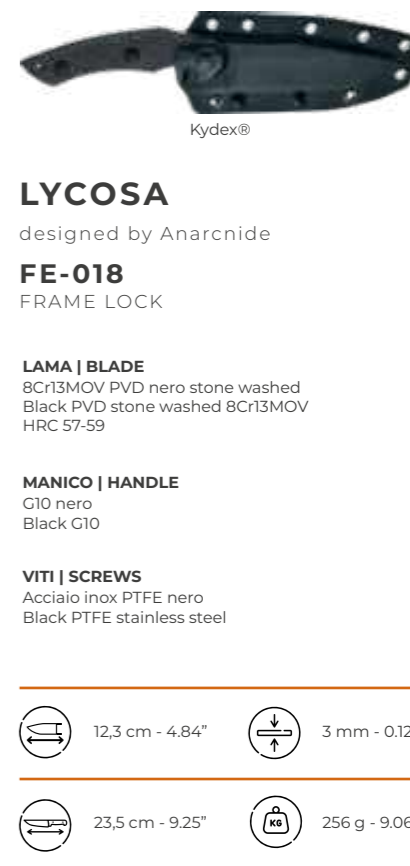



## **ACCESSORI** **ACCESSORIES**

Fox Knives offre una gamma di accessori utili per la manutenzione, protezione ed esposizione dei coltelli, come pietre e acciaino per l'affilatura, foderi di diverse misure e materiali e diversi articoli per gli affezionati al marchio come penne, berretti e zainetto.

Fox Knives offers a range of useful accessories for knife maintenance, protection, and display, such as sharpening stones and sharpening tool, sheaths of different sizes and materials, and various items for brand loyalists such as pens, caps, and backpack.

# FX-PEN01 PENS

## FX-PEN01 CO

- Rame  
Copper
- Titanio PVD nero  
Black PVD titanium



tot 12 cm - 4.72"

kg 95 g - 3.35 oz

## FX-PEN01 TICF

- Fibra di carbonio +  
titanio anod.blu  
Carbon fiber +  
blue anod. titanium
- Fibra di carbonio  
Carbon fiber



tot 12 cm - 4.72"

kg 35 g - 1.23 oz

## FX-PEN01 TIBSW

- Titanio PVD nero stone  
washed  
Black PVD stone  
washed titanium
- Titanio PVD nero stone  
washed  
Black PVD stone  
washed titanium



tot 12 cm - 4.72"

kg 55 g - 1.94 oz

# MTD TACTICAL PEN

designed by Allen Elishewitz



## MTD BL

**CORPO | BODY**  
Alluminio anodizzato blu  
Blue anodized aluminum

**CLIP**  
Acciaio inox  
Stainless steel

tot 13,7 cm - 5.40"

kg 35 g - 1.23 oz



## MTD G

**CORPO | BODY**  
Alluminio anodizzato grigio  
Grey anodized aluminum

**CLIP**  
Acciaio inox  
Stainless steel

tot 13,7 cm - 5.40"

kg 35 g - 1.23 oz



## MTD OD

**CORPO | BODY**  
Alluminio anodizzato verde OD  
OD green anodized aluminum

**CLIP**  
Acciaio inox  
Stainless steel

tot 13,7 cm - 5.40"

kg 35 g - 1.23 oz



## MTD BR

**CORPO | BODY**  
Alluminio anodizzato marrone  
Brown anodized aluminum

**CLIP**  
Acciaio inox  
Stainless steel

tot 13,7 cm - 5.40"

kg 35 g - 1.23 oz



## MTD R

**CORPO | BODY**  
Alluminio anodizzato rosso  
Red anodized aluminum

**CLIP**  
Acciaio inox  
Stainless steel

tot 13,7 cm - 5.40"

kg 35 g - 1.23 oz



## MTD O

**CORPO | BODY**  
Alluminio anodizzato arancione  
Orange anodized aluminum

**CLIP**  
Acciaio inox  
Stainless steel

tot 13,7 cm - 5.40"

kg 35 g - 1.23 oz

# MTD TACTICAL PEN



## MTD/2 BL

### CORPO | BODY

Alluminio anodizzato blu  
Blue anodized aluminum

### CLIP

Acciaio inox  
Stainless steel

 15 cm - 5.90"

 35 g - 1.23 oz



## MTD/2 OD

### CORPO | BODY

Alluminio anodizzato verde  
OD green anodized aluminum

### CLIP

Acciaio inox  
Stainless steel

 15 cm - 5.90"

 35 g - 1.23 oz



## MTD/2 O

### CORPO | BODY

Alluminio anodizzato arancione  
Orange anodized aluminum

### CLIP

Acciaio inox  
Stainless steel

 15 cm - 5.90"

 35 g - 1.23 oz



## MTD/2 R

### CORPO | BODY

Alluminio anodizzato rosso  
Red anodized aluminum

### CLIP

Acciaio inox  
Stainless steel

 15 cm - 5.90"

 35 g - 1.23 oz

# BF-300 ACCIAINO DIAMANTATO - DIAMOND SHARPENER

## BF-300

 22,5 cm - 8.85"

Affilacoltelli tascabile con acciaio richiudibile diamantato a profilo ovale. Grazie al rivestimento in polvere di diamante, assicura un'eccellente affilatura delle lame, rendendolo adatto sia per coltelli da cucina che per quelli tascabili. Compatto e pratico, è facilmente trasportabile e, una volta chiuso, offre una protezione efficace da graffi e contatti accidentali con altri utensili.

Pocket knife sharpener with resealable diamond oval profile sharpener. With its diamond powder coating, it ensures excellent sharpening of blades, making it suitable for both kitchen and pocket knives. Compact and practical, it is easily transportable and, when closed, offers effective protection from scratches and accidental contact with other tools.



## CLIP FX-211/213 MOLLE - LOCK CLIP

Nylon® rinforzato  
Reinforced Nylon®

 12 x 2,4 cm - 4.72" x 0.94"



## CLIP FX-211/213 SURVIVAL CARD

Acciaio inox  
Stainless steel

 7 cm - 2.76"  30 gr - 1.06 oz

### STRUMENTI | TOOLS

- Righello / Ruler
- Magnete / Magnet
- Lama / Blade
- Cacciavite / Screwdriver
- Stringi bulloni / Bolt tightener
- Apri scatole / Box opener
- Attacco portachiavi / Keychain attachment
- Estrattore per chiodi / Nail extractor
- Seghetto / Saw

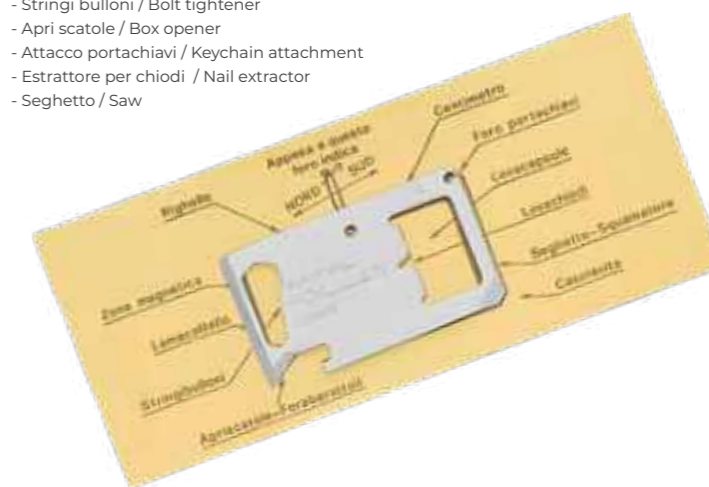

# FODERI SHEATHS

## FODF3

Fodero con zip in Nylon®  
Nylon® zipper sheath

**tot** 15 x 7 cm / 5.90" x 2.75"



## FODF3 NEUTRO

Fodero con zip in Nylon® con tessuto a strappo per patch  
Nylon® zippered sheath with tear-away fabric for patches

**tot** 15 x 7 cm / 5.90" x 2.75"



## FODF3 CUOIO N

Fodero con zip in cuoio nero  
Black leather zipper sheath

**tot** 15 x 7 cm / 5.90" x 2.75"



Fodero in Nylon®  
Nylon® sheath

## 35cm12

**tot** 12 cm - 4.72"



## 35cm13

**tot** 13 cm - 5.11"

## 35cm14

**tot** 14 cm - 5.51"

Fodero in Nylon®  
Nylon® sheath

## 48cm13

**tot** 13 cm - 5.11"



## 49cm14

**tot** 14 cm - 5.51"

Fodero in Ballistic Nylon®  
Ballistic Nylon® sheath

## 47cm10

**tot** 10 cm - 3.93"



## FODF1

Fodero con zip in Nylon®  
Nylon® zipper sheath

**tot** 45 x 30 cm / 17.71" x 11.81"



## FODF4

Fodero con zip in Nylon®  
Nylon® zipper sheath

**tot** 45 x 30 cm / 17.71" x 11.81"



# FODERI SHEATHS

## FODF6 CUOIO

Fodero con zip in cuoio marrone  
Brown leather zipper sheath

**tot** 17 x 9,5 cm / 6.69" x 3.74"



Fodero in cuoio marrone per tagliasigari 749 SM  
Brown leather sheath for 749 cigar cutter

## FOD.749SM

**tot** 10 cm - 3.93"



Fodero in cuoio marrone  
Brown leather sheath

## 42cm13

**tot** 13 cm - 5.11"



## 43cm14

**tot** 14 cm - 5.51"

Fodero in cuoio marrone  
Brown leather sheath

## 38cm10

**tot** 10 cm - 3.93"



Fodero in cuoio marrone  
Brown leather sheath

## 44/1

**tot** 11 cm - 4.33"  
Profondità  
Depth: 1,5 cm - 0.6"

## 44/2

**tot** 11 cm - 4.33"  
Profondità  
Depth: 2 cm - 0.8"

## 44/3

**tot** 11 cm - 4.33"  
Profondità  
Depth: 2,5 cm - 0.10"



Fodero in cuoio marrone  
Brown leather sheath

## 36cm09

**tot** 9 cm - 3.54"

## 37cm12

**tot** 12 cm - 4.72"



## EXPO-UNIV-01

Plexiglass

**tot** H 30 x 35 x 20 cm  
H 11.8 " x 13.7 " x 7.87"



## EXPO 6

Cuoio nero  
Black leather

**tot** H 9 x 13,3 x 17,5 cm  
H 3.54 " x 5.23 " x 6.88"



## EXPO 11

Plastica  
Plastic

**tot** H 5 x 9,5 x 14,5 cm  
H 1.96 " x 3.74 " x 5.70"



## EXPO 12

Plastica  
Plastic

**tot** H 4 x 4 cm  
H 1.57 " x 1.57"



## EXPO 13

Plastica  
Plastic

**tot** H 13,5 x 11 x 8,5 cm  
H 5.31 " x 4.33 " x 3.34"



## EXPO 14

Plastica  
Plastic

**tot** H 9,5 x 19 x 24 cm  
H 3.74 " x 7.48 " x 9.44"



## FX-MATB FX-MATGR

Cuoio nero o verde OD  
Black or OD green leather

**tot** 38 x 25 cm  
14.96 " x 9.84 "



**tot** 40 cm - 15.74"

Acciaio nichelato  
Nickel plated steel

92



93



96



97



98



99



## FX-ZF01

**tot** H 40 x 39 cm  
15.74 " x 15.35"



## FX-CAP02B

## FX-CAP02BL

## FX-CAP02OL

Taglia unica regolabile  
One size adjustable



**LEGENDA E SOMMARIO**  
KEY AND SUMMARY

# LEGENDA ICONE ICONS KEY

|  |  |   |
|--|--|---|
|  ACCIAIO, FINITURA E HRC DELLA LAMA<br>STEEL, FINISHING AND HRC OF THE BLADE              |  MATERIALE DELL'ANELLO KARAMBIT<br>KARAMBIT RING MATERIAL |  LUNGHEZZA LAMA<br>BLADE LENGTH                         |
|  MATERIALE DEL MANICO<br>HANDLE MATERIAL  |  MATERIALE DELLA CLIP<br>CLIP MATERIAL                    |  LUNGHEZZA TOTALE<br>TOTAL LENGTH                       |
|  MATERIALE DEL RADIUS LOCK<br>RADIUS LOCK MATERIAL  |  MATERIALE DEI RIVETTI<br>RIVETS MATERIAL                 |  SPESSORE DELLA LAMA<br>BLADE THICKNESS                 |
|  MATERIALE DEI VARI SISTEMI DI BLOCCO/APERTURA<br>MATERIAL OF THE VARIOUS LOCKING/OPENING |  MATERIALE DELLE BOCCOLE<br>RIVETS MATERIAL               |  PESO<br>WEIGHT   |
|  MATERIALE DEL DISTANZIALE E DEGLI STANDOFF<br>MATERIAL OF THE SPACER AND STANDOFFS       |  MATERIALE DELLE VITI<br>SCREWS MATERIAL                  |  LUNGHEZZA TOTALE DELL'ARTICOLO<br>TOTAL LENGTH OF ITEM |



**FOX NATIVE BUSHCRAFT FX-611**  
Lama D2 black idroglied stone washed | Black idroglied stone washed D2 blade  
Manico Micarta nera sabbiata | Black sandblasted Micarta handle

## FOX KNIVES CHIUDIBILI | FOLDING.....22

|                       |                         |                        |                          |
|-----------------------|-------------------------|------------------------|--------------------------|
| FX-130 DW ..... 90    | FX-526 ALB ..... 50     | FX-543 ALO ..... 71    | FX-582 CF ..... 87       |
| FX-130 MBSW ..... 90  | FX-526 ALG ..... 50     | FX-543 CFBR ..... 70   | FX-582 MI ..... 87       |
| FX-230 MI ..... 84    | FX-526 ALO ..... 50     | FX-543 CFO ..... 70    | FX-582 OL ..... 87       |
| FX-230 MI G ..... 84  | FX-526 CF ..... 48      | FX-550 CFB ..... 32    | FX-604 ..... 59          |
| FX-230 OL ..... 84    | FX-526 CFBL ..... 48    | FX-550 DGCFR ..... 32  | FX-604 ALBR ..... 56     |
| FX-230 ZW ..... 84    | FX-526LI CF ..... 48    | FX-550 G10B ..... 33   | FX-604 ALSW ..... 56     |
| FX-273 ..... 86       | FX-526LI MB ..... 49    | FX-550 G10OD ..... 33  | FX-604 B ..... 58        |
| FX-273 CF ..... 86    | FX-526LI MBU ..... 49   | FX-550 Ti ..... 33     | FX-604 BL ..... 59       |
| FX-273 MI ..... 86    | FX-526LI MNA ..... 49   | FX-550 TiB ..... 33    | FX-604 CF ..... 56       |
| FX-273 ZW ..... 86    | FX-526LI MOD ..... 49   | FX-551 ALB ..... 31    | FX-604 MBR ..... 57      |
| FX-302 ..... 45       | FX-526 SX TIBL ..... 47 | FX-551 ALG ..... 31    | FX-604 MFG ..... 57      |
| FX-302 MIN ..... 45   | FX-526 SX TIBR ..... 47 | FX-551 SX ALB ..... 31 | FX-604 MN ..... 57       |
| FX-302 MOD ..... 45   | FX-526 TI BB ..... 47   | FX-551 SX Ti ..... 31  | FX-604 OD ..... 58       |
| FX-308 ZW ..... 45    | FX-527 CF ..... 51      | FX-551 Ti ..... 31     | FX-604 OR ..... 58       |
| FX-311 B ..... 44     | FX-527LI CF ..... 51    | FX-551 TiCOP ..... 30  | FX-604 R ..... 59        |
| FX-311 CT ..... 44    | FX-527LI MB ..... 53    | FX-551 TiPVD ..... 30  | FX-608 B ..... 54        |
| FX-311 GY ..... 44    | FX-527LI MBU ..... 53   | FX-552 AL ..... 35     | FX-608 BL ..... 55       |
| FX-311 OD ..... 44    | FX-527LI MNA ..... 53   | FX-552 ALBOR ..... 35  | FX-608 CF ..... 54       |
| FX-503 ALB ..... 78   | FX-527LI MOD ..... 53   | FX-552 ALBR ..... 35   | FX-608 OR ..... 55       |
| FX-503 ALOD ..... 78  | FX-527 TI ..... 52      | FX-552 ALCF ..... 35   | FX-608 R ..... 55        |
| FX-503SP B ..... 78   | FX-527 TIPVD ..... 52   | FX-555 DM ..... 28     | FX-608 TI ..... 54       |
| FX-503SP OD ..... 78  | FX-528 B ..... 91       | FX-555 DPB ..... 28    | FX-612 BB ..... 62       |
| FX-515 W ..... 39     | FX-530 ALBL ..... 65    | FX-555 TIBL ..... 29   | FX-612 BLB ..... 63      |
| FX-518 O ..... 68     | FX-530 ALOD ..... 65    | FX-555 TIBR ..... 29   | FX-612 BLS ..... 61      |
| FX-518 ZW ..... 68    | FX-530 CF ..... 64      | FX-555 TICF ..... 29   | FX-612 BS ..... 61       |
| FX-519 ..... 69       | FX-530 CFDSW ..... 64   | FX-556-A1 ..... 25     | FX-612 ODB ..... 62      |
| FX-519 GR ..... 69    | FX-530 G10B ..... 65    | FX-556-A2 ..... 26     | FX-612 ODS ..... 61      |
| FX-519 O ..... 69     | FX-530 MOD ..... 65     | FX-556-A4 ..... 26     | FX-612 ORB ..... 63      |
| FX-519 ZW ..... 69    | FX-530 TIASW ..... 64   | FX-556-B1 ..... 25     | FX-612 RB ..... 63       |
| FX-524 B ..... 75     | FX-530 TIDSW ..... 64   | FX-556-B4 ..... 27     | FX-624 B ..... 60        |
| FX-524 G ..... 75     | FX-533 CF ..... 67      | FX-556-B5 ..... 27     | FX-624 OR ..... 60       |
| FX-524 MB ..... 74    | FX-537 BR ..... 67      | FX-556-B6 ..... 27     | FX-ATC-OG01 ..... 38     |
| FX-524 MJ ..... 75    | FX-537 SW ..... 67      | FX-557 ..... 81        | FX-ATC-OG01 LMB ..... 38 |
| FX-524 OL ..... 74    | FX-538 G10B ..... 66    | FX-557 B ..... 81      | FX-ATC-OG01 MOD ..... 38 |
| FX-524 TI ..... 73    | FX-538 MP ..... 66      | FX-558 BI ..... 88     | FX-ATC-OG02-DCF ..... 36 |
| FX-524 TICF ..... 73  | FX-539 OL ..... 66      | FX-558 BO ..... 88     | FX-ATC-OG02-MCF ..... 37 |
| FX-524 TIZW ..... 73  | FX-539 ST ..... 66      | FX-558 OL ..... 88     | FX-ATC-OG02-MD ..... 37  |
| FX-524 ZW ..... 74    | FX-540 B ..... 82       | FX-560 ALBR ..... 43   | FX-F2017 ..... 76        |
| FX-525 B ..... 40     | FX-540 G10OD ..... 83   | FX-560 ALOR ..... 43   | FX-F2017 D ..... 76      |
| FX-525 BE ..... 41    | FX-540 NA ..... 83      | FX-560 CFOR ..... 43   | FX-F2017 R ..... 76      |
| FX-525 DB ..... 40    | FX-540 OD ..... 82      | FX-560 G10B ..... 43   | SK-02 BSW ..... 91       |
| FX-525 MI ..... 39    | FX-540 TIB ..... 82     | FX-570 Ti ..... 79     | SK-02 OD ..... 91        |
| FX-525 OL ..... 40    | FX-540 TIBL ..... 83    | FX-570 TiB ..... 79    | SK-02 PVD ..... 91       |
| FX-525 Ti ..... 41    | FX-543 ALB ..... 71     | FX-570 TiD ..... 79    |                          |
| FX-525 Ti BL ..... 41 | FX-543 ALG ..... 71     | FX-582 ..... 87        |                          |

## FOX KNIVES KARAMBIT.....92

|                      |                         |                       |                        |
|----------------------|-------------------------|-----------------------|------------------------|
| 478 ..... 101        | FX-536 OD ..... 103     | FX-599 ..... 98       | FX-653 ..... 105       |
| 479 ..... 101        | FX-536 ODB ..... 103    | FX-599 ALB-1 ..... 94 | FX-800 MK ..... 111    |
| 479 TK ..... 101     | FX-556 P ..... 103      | FX-599 ALB-2 ..... 95 | FX-800 MKOR ..... 111  |
| FX-535 ..... 102     | FX-556 PB ..... 103     | FX-599 ALB-3 ..... 95 | FX-801 MK ..... 111    |
| FX-535 B ..... 102   | FX-590 ..... 104        | FX-599 ALB-4 ..... 95 | FX-802 ..... 108       |
| FX-535 BL ..... 102  | FX-591 ..... 112        | FX-599 ALB-5 ..... 95 | FX-802 TiPVD ..... 108 |
| FX-535 BLB ..... 102 | FX-591 OD ..... 113     | FX-599 RS ..... 99    | FX-802 TK ..... 108    |
| FX-535 O ..... 102   | FX-591 ODSW ..... 113   | FX-599 RSY ..... 99   | FX-803 ..... 107       |
| FX-535 OB ..... 102  | FX-591 TiC B ..... 112  | FX-599TiC ..... 97    | FX-803 TiPVD ..... 107 |
| FX-535 R ..... 102   | FX-591 TiC BR ..... 112 | FX-599TiCS ..... 97   | FX-826 ..... 104       |
| FX-535 RB ..... 102  | FX-591 TK ..... 113     | FX-599 TK ..... 98    |                        |
| FX-536 ..... 103     | FX-597 ..... 109        | FX-599 XT ..... 100   |                        |
| FX-536 B ..... 103   | FX-597 OD ..... 109     | FX-599 XTS ..... 100  |                        |
| FX-536 CB ..... 103  | FX-597 TK ..... 110     | FX-599 XTTK ..... 100 |                        |
| FX-536 CBB ..... 103 | FX-597 XT ..... 110     | FX-650 ..... 105      |                        |
| FX-536 G ..... 103   | FX-597 XTS ..... 110    | FX-651 ..... 105      |                        |
| FX-536 GB ..... 103  | FX-597 XTTK ..... 110   | FX-652 ..... 105      |                        |

FOX KNIVES FISSI | FIXED.....114

658.....145 FX-106 TICF.....117 FX-593 AF.....144 FX-654 CR.....119
660.....145 FX-106 TIZW.....117 FX-606.....122 FX-661 OL.....139
680.....147 FX-131 DW.....135 FX-609 OD.....131 FX-662 OL.....140
680 T.....147 FX-131 MBSW.....135 FX-610.....131 FX-662 OR.....140
682.....148 FX-132 MGT.....131 FX-611.....130 FX-663 OL.....141
682 M.....148 FX-133 MGT.....131 FX-616 MB.....132 FX-663 OR.....141
682 N.....148 FX-140XL MB.....129 FX-616 OL.....132 FX-664 OL.....141
683.....147 FX-143 MB.....129 FX-620 B.....142 FX-664 OR.....141
1502 OL.....142 FX-510.....122 FX-621 B.....142 FX-679.....147
1503 OL.....142 FX-510 OD.....123 FX-623 BA.....124 FX-693.....146
1504 OL.....143 FX-529 TR.....122 FX-623 ODA.....124 FX-694.....146
1505 OL.....143 FX-553 B.....121 FX-633.....123 FX-695.....146
1506 OL.....143 FX-554 B.....121 FX-633 MOD.....123 FX-700.....149
1507 OL.....143 FX-592.....144 FX-634.....120 FX-701.....149
FX-103 MB.....128 FX-592 AF.....144 FX-634 DCFB.....120 FX-GAL-20.....127
FX-105 MB.....128 FX-592 W.....144 FX-634 MOD.....120 TK-FX01.....137
FX-106 DCF.....116 FX-592 WAF.....144 FX-649 OL.....134
FX-106 MIOD.....117 FX-593.....144 FX-649 SA.....134

FOX KNIVES MULTIUSO, UTILITY E RESCUE | MULTIPURPOSE, UTILITY AND RESCUE..... 150

2C 203/16 B.....179 356/16 B.....178 FX-VP108 OR.....168 FX-VP130-S4 CF.....161
2C 204/19 B.....179 356/20.....178 FX-VP108 OT.....156 FX-VP130-S4 OD.....167
2C 205/20 B.....179 369/13 B.....178 FX-VP108 OTB.....156 FX-VP130-S4 OR.....169
2C 205/E P B.....176 369/15 B.....177 FX-VP108 SB.....164 FX-VP130-S4 SB.....165
2C 206/E B.....176 369/17 B.....177 FX-VP108 TI.....158 FX-VP130-S4 TI.....159
2C 210/17 B.....176 369/19 B.....177 FX-VP130-3 BK.....163 FX-VP130 SB.....164
2C 211/17 B.....177 403.....174 FX-VP130-3 CF.....161 FX-VP130-SF5 BK...163
2C 220/19 B.....179 404.....174 FX-VP130-3 OD.....167 FX-VP130-SF5 CF.....161
2C 223 B.....176 405.....174 FX-VP130-3 OR.....169 FX-VP130-SF5 OD...167
2C 225 B.....176 405 OL.....174 FX-VP130-3 SB.....165 FX-VP130-SF5 OR...169
2C 239/LE B.....177 406 B.....175 FX-VP130-3 TI.....159 FX-VP130-SF5 SB...165
2C 242/18 B.....178 406 R.....175 FX-VP130 BK.....162 FX-VP130-SF5 TI.....159
2C 242/E B.....177 406 Y.....175 FX-VP130 CF.....160 FX-VP130 TI.....158
2C 261/18.....180 408.....173 FX-VP130-F4 BK.....163 FX-VPGP130 BK.....153
2C 262/30.....180 408 G10.....173 FX-VP130-F4 CF.....161 FX-VPGP130 MG.....153
2C 263/30.....180 640.....181 FX-VP130-F4 OD.....167 FX-VPGP130 OR.....153
2C 264/30.....180 640/1.....181 FX-VP130-F4 OR.....169 FX-VPGP130 RD.....153
226/6 CE.....170 640 OD.....181 FX-VP130-F4 SB.....165 FX-VPGP130 TI.....152
226/7 CE.....170 FX-409.....172 FX-VP130-F4 TI.....159 FX-VPGPW-130-F3 BK..154
226/7 SCE.....170 FX-409 OL.....172 FX-VP130 OD.....166 FX-VPGPW-130-F3 MG..155
226/8 SCE.....170 FX-639 RD.....181 FX-VP130 OR.....168 FX-VPGPW-130-F3 OR..155
300/18 B.....179 FX-VP108 BK.....162 FX-VP130 OT.....156 FX-VPGPW-130-F3 R...155
301/18 B.....179 FX-VP108 CF.....160 FX-VP130 OTB.....156 FX-VPGPW-130-F3 TI...154
343/20.....178 FX-VP108 OD.....166 FX-VP130-S4 BK.....163

FOX KNIVES TAGLIASIGARI | CIGARCUTTERS.....182

743.....191 746.....185 FX-541 TI.....195
743 3KT.....191 746 BSW.....185 FX-541 WW.....195
743 B.....184 747.....184
743 OR.....191 747 BSW.....184
744.....193 747 DS.....184
744 AW.....193 749/1 SM.....187
744 CFD.....192 749/1 SM BSW.....187
744 CFF.....192 749 D.....186
744 OL.....193 749 SM BSWF.....186
744 ZW.....193 749 SMF.....186
745.....188 FX-541 CF.....194
745 F.....188 FX-541 DMG.....194
745 S.....188 FX-541 ST.....195

FOX KNIVES LINEA CLASSICA | CLASSIC LINE..... 196

201.....204 294.....204 594 MI.....201 647.....202
202.....204 445OL.....202 594 OL.....201 648.....202
221/1.....199 500 B.....198 594 RF.....201 691/18.....205
251.....204 573 CF.....199 610/11.....202 697 T.....205
256.....204 575PW.....200 610/13.....202 698.....205
257.....204 583.....200 639 CE.....202 1699 CH.....205
271 OL.....198 590.....199 641.....203 1699 N.....205
273 DOL.....198 593.....200 643/11.....203 FX-RL01 G10.....199
273 OL.....198 593CE.....200 646/11.....203

FOX KNIVES FKMD.....206

641/11FNK.....228 FX-449 OD.....211 FX-689.....223 FX-ALSR-49.....212
676.....235 FX-500.....214 FX-689 B.....223 FX-G2B.....226
EX-001620-BLK.....235 FX-501.....214 FX-3002.....231 FX-MIR115/2 VVF.....233
FIRE STARTER.....235 FX-504 B.....213 FX-3003.....231 FX-MP01 TI KIT.....235
FX-9CM01 B.....225 FX-505.....215 FX-3005.....228 FX-MP01 TI KIT EOD235
FX-9CM02B.....225 FX-505 GR.....215 FX-0107153.....224 FX-MTF5.....213
FX-9CM04 BT.....232 FX-506.....215 FX-0107153/1SK.....235 FX-NR01 TT.....227
FX-9CM04 T.....232 FX-507.....222 FX-0171100.....222 FX-NR03 CUC.....227
FX-9CM05 T.....232 FX-507 AF.....222 FX-0171100 AF.....222 FX-P1DC.....227
FX-9CM06.....225 FX-532.....213 FX-0171101 B.....230 FX-P1M.....227
FX-9CM07.....224 FX-595 W.....221 FX-0171102.....229 FX-P3B.....226
FX-401 OR.....213 FX-596.....221 FX-0171106.....230 FX-RCSTF-02.....212
FX-446 B.....209 FX-596 AF.....221 FX-0171107.....230 OMG-1.....226
FX-446 BS.....208 FX-601.....226 FX-0171111.....234 SF-DB03.....228
FX-446 GR.....209 FX-626.....216 FX-0171111 B.....234 SF-F2000.....228
FX-446 OD.....209 FX-627 G10B.....217 FX-0171112.....228 SF-F2000 FN.....228
FX-446 ODS.....208 FX-627 G10OD.....217 FX-0171114.....229 SOG 182/B66.....237
FX-447 C.....212 FX-628 G10B.....218 FX-0171115.....229 SOG 182/B66 EOD..237
FX-448 B.....210 FX-628 G10OD.....218 FX-0171116.....231 SOG PA1001-CP.....236
FX-448 OD.....210 FX-647.....219 FX-0171117.....231 SOG PA2001-CP.....236
FX-448 T.....210 FX-647 AF.....219 FX-0193000.....230 SOG PL1001-CP.....237
FX-449 B.....211 FX-647 S.....219 FX-0193001.....230 SOG PP1001-CP.....237

VIPER CHIUDIBILI | FOLDING.....238

V6002GR.....248 V5742CI.....267 V5972FC.....255 V6004BC.....245
V6002CN.....248 V5742NO.....267 V5974BC.....255 V6004NO.....245
V5992FCR.....252 V5742PC.....267 V5976CN.....253 V6006CV.....245
V5400BC.....261 V5744CB.....266 V5976FC.....253 V6006FCP.....245
V5400CB.....261 V5744PC.....266 V5978CV.....253 V6006GG.....245
V5400IN-BC.....265 V5746CB.....267 V5978FCB.....253 V6007DTBL.....244
V5400IN-GH.....265 V5746PC.....267 V5980FCM.....247 V6008FCM.....243
V5411BC.....261 V5748CO.....266 V5982CB.....247 V6008FCV.....243
V5411CB.....261 V5750PC.....266 V5982CG.....247 V6010GG.....243
V5411UL.....261 V5750UL.....266 V5982GB3D.....247 V6010GR.....243
V5500IN-BC.....265 V5901CB.....259 V5984TI.....247 V6010TE.....243
V5500IN-GH.....265 V5903FC.....259 V5984TI3D.....247 V6012CG.....242
V5500UL.....260 V5905CV.....259 V5985BC.....247 V6012IM.....242
V5510BC.....260 V5910CB.....258 V5985Z1.....247 V6012UT.....242
V5510CB.....260 V5910FC.....258 V5990BRS.....252 V6014FCG.....242
V5510MO.....260 V5912CG.....258 V5990DBRS.....252 V6016CG3D.....241
V5510UL.....260 V5912FC.....258 V5992CG.....252 V6016IM3D.....241
V5600CB.....262 V5912GO.....258 V5992FCR.....252 V6018BC3D.....241
V5600PC.....262 V5918GB.....254 V5996TI.....251 V6018FC3D.....241
V5700IN-AL.....264 V5918GG.....254 V5996TI3D.....251 V6020FC.....240
V5700IN-BC.....264 V5920GB.....254 V5997TI.....251 V6020GB.....240
V5700IN-FO.....264 V5928UL.....249 V5997TI3D.....251 V6020TI3DBL.....240
V5700IN-GH.....264 V5928ZI.....249 V5998CG.....251 V6022CG.....240
V5700IN-PN.....264 V5962TIBL.....257 V5998FC.....251 VA5918BSW.....254
V5700MO.....263 V5962TIBR.....257 V6002CN.....248 VA5964BL.....256
V5700UL.....263 V5962TITI.....257 V6002FCG.....248 VA5964TIBR.....256
V5740PC.....266 V5963TITI.....257 V6002GI.....248 VA5980FCM.....246
V5740UL.....266 V5972CV.....255 V6002GR.....248

**VIPER FISSI | FIXED.....268**

|                   |                    |                    |                   |
|-------------------|--------------------|--------------------|-------------------|
| V4870UL.....286   | VT4026CG .....281  | VT4044GG .....273  | VT4060CD .....274 |
| V4880BC.....284   | VT4026FCM.....281  | VT4046BC .....273  | VT4060CG .....274 |
| V4880UL.....284   | VT4034CG .....281  | VT4046UL .....273  | VT4062BC .....275 |
| VT4002ECB.....285 | VT4034FCM .....281 | VT4048BC .....279  | VT4064CD .....275 |
| VT4003ECB.....285 | VT4038BC .....276  | VT4048FCM .....279 | VT4064CG .....275 |
| VT4012CB .....282 | VT4038FCM .....276 | VT4048NO .....279  | VT4066CG .....271 |
| VT4012DGJ.....282 | VT4038NO .....276  | VT4050CG .....279  | VT4066CN .....271 |
| VT4012DGR.....282 | VT4040CG .....277  | VT4050CN .....279  | VT4066GG .....271 |
| VT4012FC.....282  | VT4040GG .....277  | VT4050GG .....279  | VT4068BC .....271 |
| VT4014CG .....283 | VT4042CG .....277  | VT4054CG .....272  | VT4068FC.....271  |
| VT4014DCG.....283 | VT4042GG .....277  | VT4054GG .....272  | VT4068UL.....271  |
| VT4014FC .....283 | VT4042UT.....277   | VT4056BC .....272  |                   |
| VT4014FCM.....283 | VT4044CG .....273  | VT4058BC .....274  |                   |

**BLACK FOX .....288**

|                       |                      |                    |                     |
|-----------------------|----------------------|--------------------|---------------------|
| BF-80 .....306        | BF-719 MIN .....304  | BF-753.....309     | BF-770 BB.....291   |
| BF-81 .....306        | BF-719 ZW.....304    | BF-754 .....309    | BF-770 BL.....291   |
| BF-105T.....306       | BF-728 .....308      | BF-755 .....309    | BF-770 WD .....291  |
| BF-115.....296        | BF-729 .....305      | BF-757 OD .....308 | BF-771 MB.....292   |
| BF-117.....296        | BF-729 SW .....305   | BF-758 .....300    | BF-771 MOD .....292 |
| BF-203 .....310       | BF-731 D2 MG.....307 | BF-758 MI .....300 | BF-781 G10 .....293 |
| BF-204 .....310       | BF-735.....309       | BF-758 MIB.....300 | BF-781 ZW.....293   |
| BF-205 .....312       | BF-740 OD .....305   | BF-760 .....298    | BF-782 OR .....294  |
| BF-205 OR .....312    | BF-741 .....308      | BF-760 W .....298  | BF-783 G10 .....294 |
| BF-206 .....311       | BF-748 CR.....299    | BF-761 OR .....302 | BF-783 ZW .....294  |
| BF-207 .....311       | BF-748 MI .....299   | BF-761 R .....302  | BF-784 OR .....296  |
| BF-237.....305        | BF-748 MIB.....299   | BF-762 BB.....298  | BF-785 G10 .....295 |
| BF-434 G10 .....306   | BF-749 .....307      | BF-762 OD .....298 | BF-785 MIBL.....295 |
| BF-434 ZW .....306    | BF-750 .....303      | BF-763 .....301    | SOLVER.....311      |
| BF-710 D2 .....307    | BF-750 BL .....303   | BF-763 CF .....301 | TS 815 .....313     |
| BF-710 D2 OD .....307 | BF-750 OD .....303   | BF-763 OR.....301  | TS 816.....313      |
| BF-712 .....308       | BF-751 .....303      | BF-764 BB .....297 | TS 819.....313      |
| BF-714 OR .....305    | BF-751 BL .....303   | BF-764 OD .....297 | TS 820 .....313     |
| BF-717 .....305       | BF-751 O .....303    | BF-765 .....297    | TS 825 .....313     |
| BF-719 G10 .....304   | BF-752 .....302      | BF-765 OD .....297 | TS 828 .....313     |
| BF-719 MI .....304    | BF-752 OD .....302   | BF-769 .....295    |                     |

**FOX EDGE .....314**

|                 |                 |                    |                 |
|-----------------|-----------------|--------------------|-----------------|
| FE-010 .....317 | FE-020 .....319 | FE-025.....318     | FE-031 .....316 |
| FE-014 .....319 | FE-022.....318  | FE-026 AOD.....317 | FE-033.....316  |
| FE-016 .....319 | FE-023.....318  | FE-027 MOD.....317 | FE-034 .....316 |
| FE-018 .....319 | FE-024 .....318 | FE-030 .....316    |                 |

**ACCESSORI | ACCESSORIES.....320**

|                 |                          |                       |                         |
|-----------------|--------------------------|-----------------------|-------------------------|
| 35cm12.....326  | 92 .....329              | EXPO-UNIV-01.....328  | FX-PEN01 TIBSW .....322 |
| 35cm13.....326  | 93 .....329              | FOD.749SM .....327    | FX-PEN01 TICF .....322  |
| 35cm14.....326  | 96 .....329              | FODF1 .....326        | FX-ZF01.....329         |
| 36cm09.....327  | 97 .....329              | FODF3 .....326        | MTD/2 BL .....324       |
| 37cm12.....327  | 98 .....329              | FODF3 CUOIO N.....326 | MTD/2 O .....324        |
| 38cm10 .....327 | 99 .....329              | FODF3 NEUTRO.....326  | MTD/2 OD .....324       |
| 42cm13.....327  | BF-300 .....325          | FODF4 .....326        | MTD/2 R.....324         |
| 43cm14 .....327 | CLIP FX-211/213 .....325 | FODF6 CUOIO.....327   | MTD BL.....323          |
| 44/1.....327    | CLIP FX-211/213 .....325 | FX-CAP02B .....329    | MTD BR .....323         |
| 44/2 .....327   | EXPO 6 .....328          | FX-CAP02BL.....329    | MTD G .....323          |
| 44/3 .....327   | EXPO 11 .....328         | FX-CAP02OL.....329    | MTD O .....323          |
| 47cm10.....326  | EXPO 12 .....328         | FX-MATB.....328       | MTD OD .....323         |
| 48cm13 .....326 | EXPO 13 .....328         | FX-MATGR.....328      | MTD R .....323          |
| 49cm14 .....326 | EXPO 14 .....328         | FX-PEN01 CO.....322   |                         |

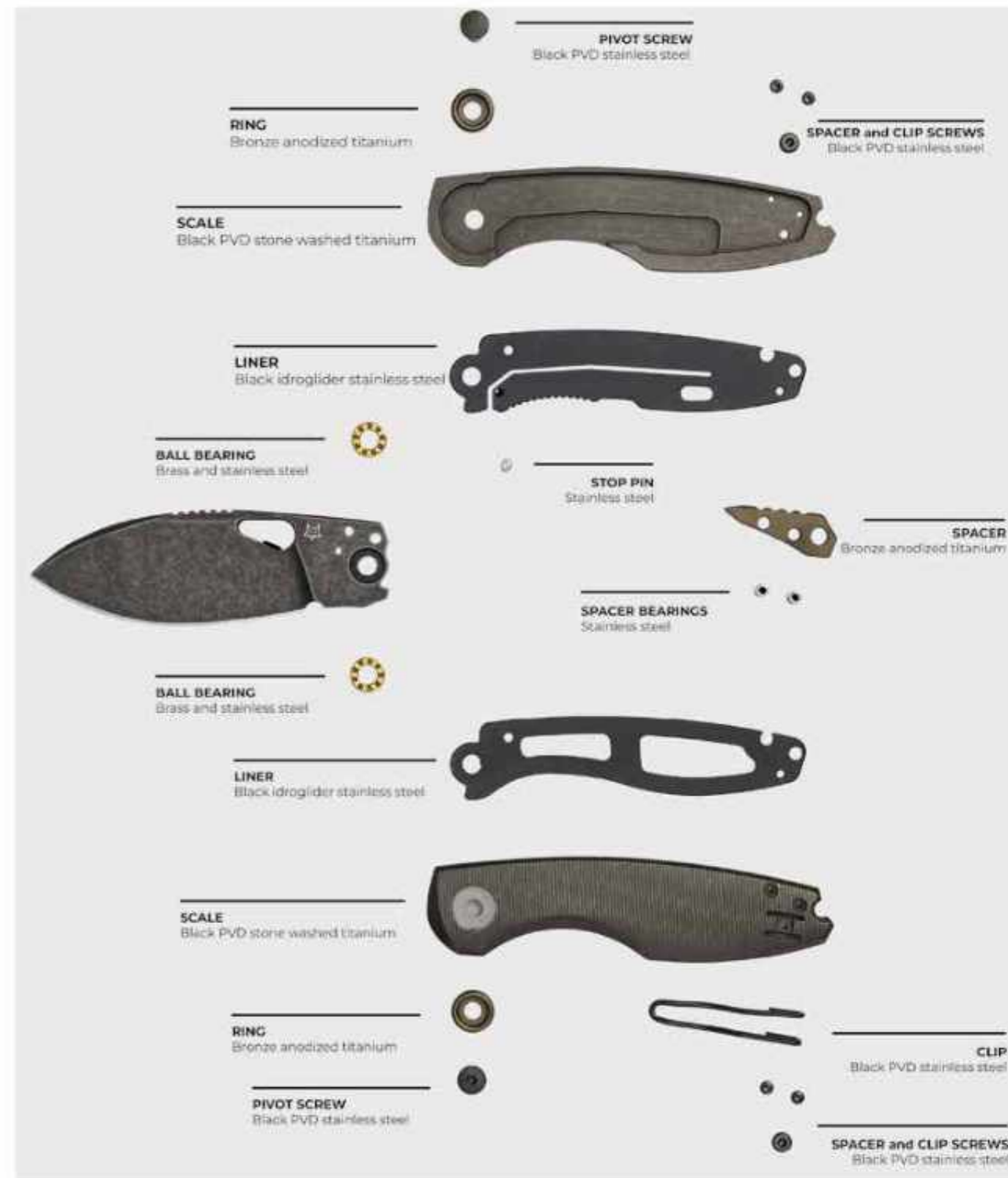

CHILIN FX-530 TID5W | designed by VOX  
 M398 PVD nero stone washed | Black PVD stone washed M390  
 Manico titanio PVD nero stone washed | Black PVD stone washed titanium handle

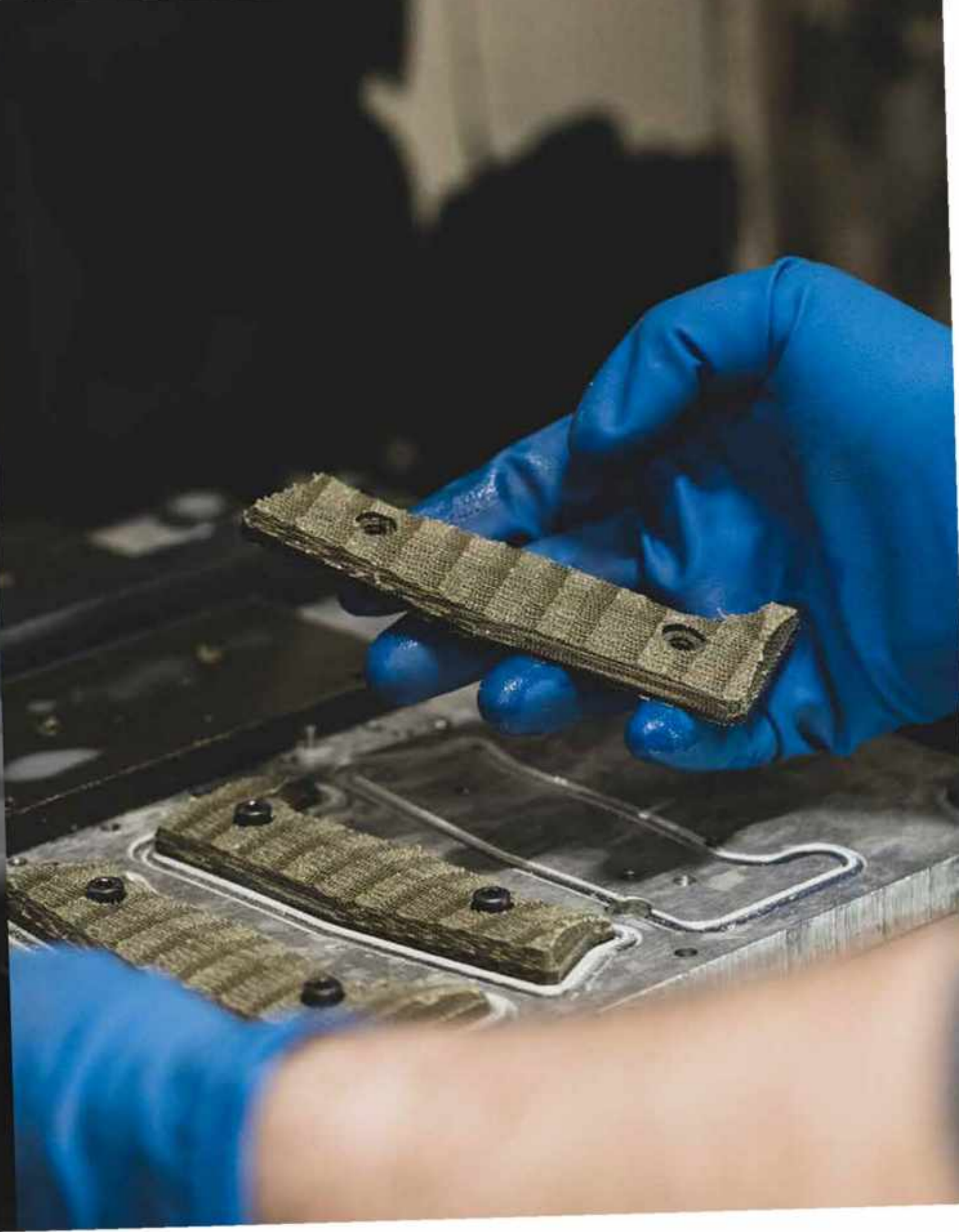



**FOX**  **KNIVES**

**FK**  **MD**



**BlackFOX** 

**FOX**  **Edge**

**ORESTE FRATI s.r.l.**

Via La Mola, 4  
33085 Maniago (PN) - ITALY

Tel: +39 0427 71814 / 730376  
Fax: +39 0427 700514

[www.foxcutlery.com](http://www.foxcutlery.com)  
[www.viper.it](http://www.viper.it)  
[www.duecignicutlery.it](http://www.duecignicutlery.it)

[info@foxcutlery.com](mailto:info@foxcutlery.com)

